

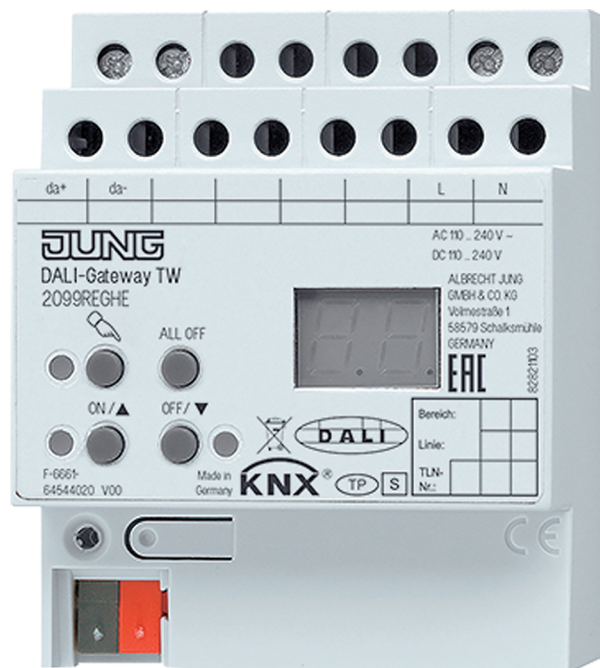

Product documentation

DALI gateway TW
Art. No. 2099REGHE



ALBRECHT JUNG GMBH & CO. KG
Volmestraße 1
58579 Schalksmühle
GERMANY

Telefon: +49 2355 806-0
Telefax: +49 2355 806-204
kundencenter@jung.de
www.jung.de

Issue: 20.07.2017
64544320

Table of Contents

1	Product definition	4
1.1	Product catalogue	4
1.2	Function	4
2	Mounting, electrical connection and operation	7
2.1	Safety instructions	7
2.2	Device components	8
2.3	Fitting and electrical connection	9
2.4	Commissioning	13
2.5	Operation	14
3	Technical data	20
4	Software description	21
4.1	Software specification	21
4.2	Software "DALI Gateway C0201x"	23
4.2.1	Scope of functions	23
4.2.2	Notes on software	25
4.2.3	Object table	26
4.2.3.1	Objects for group and single devices	26
4.2.3.2	Objects for scenes and effects	30
4.2.3.3	Object for emergency lighting	32
4.2.3.4	Objects for general functions	34
4.2.4	Functional description	39
4.2.4.1	Application basics	39
4.2.4.1.1	DALI system and addressing types	39
4.2.4.1.2	DALI emergency lighting systems	48
4.2.4.1.3	ETS plug-in	52
4.2.4.2	Description of group- and device-independent functions	60
4.2.4.2.1	DALI communication	60
4.2.4.2.2	DALI error messages	62
4.2.4.2.3	Status and feedbacks	68
4.2.4.2.4	Global switching status / Standby switch-off	72
4.2.4.2.5	Manual operation	74
4.2.4.2.6	Central function	79
4.2.4.3	Description of group and device functions	80
4.2.4.3.1	Controlling the brightness	80
4.2.4.3.2	Controlling the colour temperature	90
4.2.4.3.3	Response after a device reset	98
4.2.4.3.4	Supplementary function	104
4.2.4.3.5	Feedback functions	107
4.2.4.3.6	Automatic switch-off	117
4.2.4.3.7	Switch-on and switch-off behaviour	119
4.2.4.3.8	Staircase function	122
4.2.4.3.9	Operating hours counter	131
4.2.4.4	Scene function	135
4.2.4.5	Effect function	142

4.2.4.6	Emergency lighting	153
4.2.4.6.1	General configurations	153
4.2.4.6.2	Configurations for centrally-supplied emergency lights	155
4.2.4.7	DALI commissioning	161
4.2.4.7.1	Starting DALI commissioning	161
4.2.4.7.2	Performing DALI commissioning	163
4.2.4.7.3	Exiting DALI commissioning	178
4.2.4.7.4	Offline commissioning	181
4.2.4.7.5	Troubleshooting	184
4.2.4.8	DALI test	187
4.2.4.9	Delivery state	195
4.2.5	Parameters	196
4.2.5.1	General parameters	196
4.2.5.2	Parameters for manual operation	207
4.2.5.3	Parameters for groups and single devices	209
4.2.5.4	Parameters for scenes and effects	241
4.2.5.5	Parameters for emergency lights	248
5	Appendix	255
5.1	Index	255

1 Product definition

1.1 Product catalogue

Product name: DALI-Gateway TW
Use: Gateway
Design: RMD (rail-mounted device)
Art. No. 2099REGHE

1.2 Function

DALI

The DALI Gateway forms the interface between a KNX installation and a digital DALI (**D**igital **A**ddressable **L**ighting **I**nterface) lighting system. The DALI Gateway allows the switching and dimming of a maximum of 64 lights with a DALI operating device (e.g. electronic ballast). Up to 6 different addressing types allow group-orientated and individually-address control of DALI lights via KNX telegrams. This allows the integration of room-specific light control, for example, of open-plan offices, multipurpose spaces, production facilities, training and presentation rooms or showcases into the higher-level KNX building management. Depending on the configuration, up to 32 independent DALI groups are available for group addressing. For alternative control, these can be supplemented with 64 individually-addressable DALI device channels, as necessary.

Optionally, master control of all connected DALI components is possible (broadcast). This means that there is no need to commission DALI, meaning that lighting systems with few functions can be started up quickly and easily (simplified configuration without DALI commissioning).

Colour temperature control (DALI Device Type 8)

The DALI Gateway supports the control of DALI operating devices of the device type "Colour Control" (DALI Device Type 8) in the specific version "Tunable White (TW)". This makes it possible to control the colour temperature of a lamp by means of suitable DALI operating devices and luminaires. The Gateway allows the colour temperature control via relative or absolute dimming as well as via scenes and effects. The colour temperature control is largely independent of the brightness control and luminaire used.

DALI groups and single devices

The DALI Gateway permits the separate feedback of the individual switching and brightness statuses and also of the colour temperature of the DALI groups and single devices to the KNX. In addition, the general DALI state of operation can be signalled to the KNX (error status, short-circuit, status of the supply voltage). The function features that are independently adjustable for every light group or each single device by means of the ETS include, for example, separately configurable brightness ranges, extended feedback functions, a disabling function, or alternatively, a forced position function, separately adjustable dimming behaviour, time delays, soft dimming functions, a staircase function with supplementary functions and an operating hours counter. Moreover, the brightness values of the groups of single devices in case of bus voltage failure or bus voltage return and after ETS programming, can be preset separately. Central switching or collective feedback of all switching states is also possible.

The following functions can also be configured for operating devices that support a DALI colour temperature control: Definition of the controllable colour temperature range by minimum and maximum colour temperature, switch-on colour temperature definable, relative and absolute dimming of the colour temperature and feedback of the current colour temperature.

Furthermore, it is also possible to automatically change the colour temperature proportionally when dimming the brightness. This makes it possible with little project planning to simulate a

thermal radiator using almost any colour temperature controllable luminaire (perception of the light source such as an incandescent or halogen lamp).

Optionally, the assignment of DALI operating devices to programmed groups or single devices can be supplemented by testing of the DALI device types. If testing is enabled, the plug-in compares, during assignment as part of commissioning, the device types determined by the operating devices with the specifications by the device type parameters. Assignment can only take place if there is agreement. This will prevent functional incompatibilities after commissioning.

When using the tunable white colour temperature control, the usage and testing of the DALI device type is intended to be unchangeable.

DALI emergency lighting systems

The DALI Gateway can be integrated into DALI emergency lighting systems. It allows interference-free operation of operating devices, general lighting systems and emergency lighting operating devices of the same DALI system. The device is able to integrate standard DALI operating devices for lighting control according to IEC 62386-101 (DALI System) and IEC 62386-102 (Control-Gear) into centrally-supplied emergency lighting systems as an emergency light.

Scenes and effects

Lights or light groups can optionally be integrated in up to 16 scenes, which means that pre-programmed static light scenes can be recalled by influencing the brightness and colour temperature. If necessary, the scene values can be individually adapted and saved during device operation, allowing the user to replace the presettings of the ETS. In particular, for the implementation of dynamic light scenes, it is possible to include lights or light groups in the effect control of the DALI Gateway. Up to 16 effects are available here, each with up to 16 effect steps. Each effect step represents an individual light scene by influencing the brightness and colour temperature. Time-controlled toggling of the effect steps makes the overall effect dynamic. Brightness and colour temperature sequences can be implemented using one or more DALI groups, but also using individual DALI devices or scenes. A timer is available if necessary, which means that individual effects can be started and stopped depending on the time and weekday.

ETS plug-in

The DALI Gateway is configured and commissioned using a plug-in embedded in the ETS. For project design and commissioning of this device, we recommend using the ETS5. Project designing and commissioning of the device using ETS4 (from version 4.2) ETS3 from version "d" is also possible. Additional hardware or software is not required for the configuration and commissioning of the DALI Gateway.

The identification, addressing and assignment of DALI operating devices takes place in the DALI commissioning environment of the ETS plug-in. Commissioning can be prepared offline in the parameter configuration if necessary. Offline commissioning is ideal as the preparation for later complete commissioning, if there is no programming connection to the DALI Gateway or the DALI operating devices, but group assignment is still to take place. This is normally the case when the building planning and thus also the Gateway configuration take place earlier than the commissioning of the DALI Gateway and the DALI system.

The DALI short addresses are always assigned in the parameter configuration of the single devices and can thus be influenced. With the addition of group and device names, unique naming of DALI operating devices is possible in this way. Through the transmission of the unique names to the KNX building visualisation (e.g. control panels), the user is able - particularly during error diagnosis - to identify the lighting components easily.

DALI compatibility

The DALI Gateway has a compatibility mode for supporting non-DALI-conformant operating devices. This means that the commissioning process becomes distinctly more tolerant towards specific DALI commissioning parameters, which means that operating devices not fully compliant with the DALI specification can be commissioned, possibly subject to functional restrictions. In addition to this, a DALI telegram rate limit can be activated in the ETS plug-in, meaning that adaptation to non-DALI-conformant operating devices is possible.

Manual operation and mounting

The operating elements (4 push-buttons) on the front panel of the device allow the DALI light groups or single devices to be switched on and off or dimmed in brightness by manual operation in parallel with the KNX even without bus voltage or in a non-programmed state (broadcast of all connected DALI subscribers). This feature permits fast checking of connected loads for proper functioning.

In addition, the DALI Gateway is able to check the completeness of the operating devices integrated into the DALI system. This means that it is possible to detect the replacement of a defective electronic ballast with a new one. The automatic device replacement fulfils this function as necessary. The Gateway then transmits the configuration data to the new electronic ballast, fully automatically, without the need to carry out special commissioning. This simplifies the repair of a DALI system considerably.

The DALI Gateway is supplied completely via the mains voltage connection and makes the DALI system voltage (typ. DC 16 V) available. The mains voltage must be switched on to control the DALI interface or for programming by the ETS.

The device is designed for mounting on DIN rails in closed compact boxes or in distributors in fixed installations.

2 Mounting, electrical connection and operation

2.1 Safety instructions

Electrical equipment may only be installed and fitted by electrically skilled persons. The applicable accident prevention regulations must be observed.

Failure to observe the instructions may cause damage to the device and result in fire and other hazards.

Before working on the device or exchanging the connected DALI operating devices, disconnect it from the power supply (switch off the miniature circuit breaker), otherwise there is the risk of an electric shock.

The device is not suitable for disconnection from supply voltage.

The DALI control voltage is a functional extra-low voltage (FELV). On installing, ensure safe isolation between KNX and DALI and mains voltage. A minimum distance of at least 4 mm must be maintained between bus conductors and DALI/mains voltage cores.

The device may not be opened or operated outside the technical specifications.

2.2 Device components

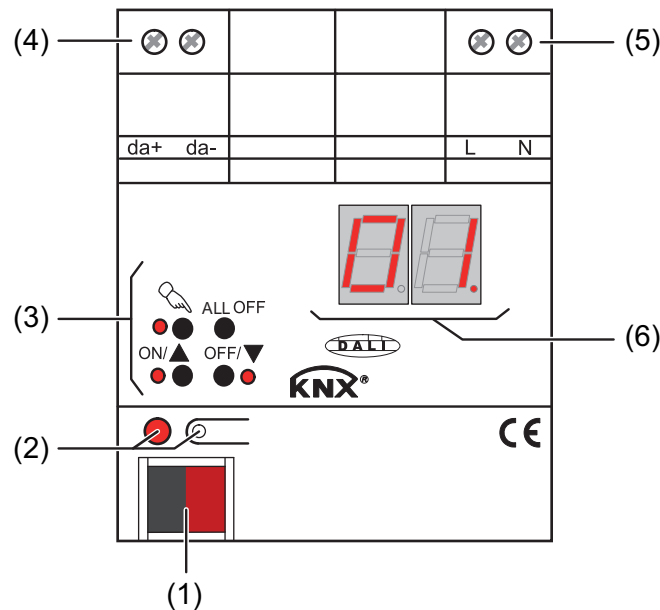

Figure 1: Device components

- (1) KNX connection
- (2) Programming button and LED (red).
- (3) Button field for manual control with status LEDs
- (4) DALI output (da+, da-)
- (5) Connection of mains voltage supply (L, N)
- (6) 7-segment display to show the DALI group or the single device selected by manual operation. Disabled in bus operation. In addition, to display additional information:

- -: Signals DALI commissioning phase or delay after an ETS programming operation or mains voltage return.

bc: Display during manual operation in an unprogrammed status (broadcast operation).

Er: Displaying an impermissible external voltage on the DALI device connection terminals (e.g. mains voltage connected). DALI Gateway without function. The Gateway is only ready for operation again when the error has been eliminated and initialisation has been performed again (mains voltage return).

LE: Signals automatic device replacement.

E: Signals an error during automatic device replacement.

2.3 Fitting and electrical connection



DANGER!

Electrical shock when live parts are touched.

Electrical shocks can be fatal.

Before working on the device, disconnect the power supply and cover up live parts in the working environment.

Fitting the device

- Fit the device by snapping it onto a mounting rail in acc. with EN 60715. The screw terminals should be at the top.
- i** A KNX data rail is not required.
- i** Observe the temperature range (see Technical Data) and ensure sufficient cooling, if necessary.

Connecting the power supply for the device electronics and DALI interface

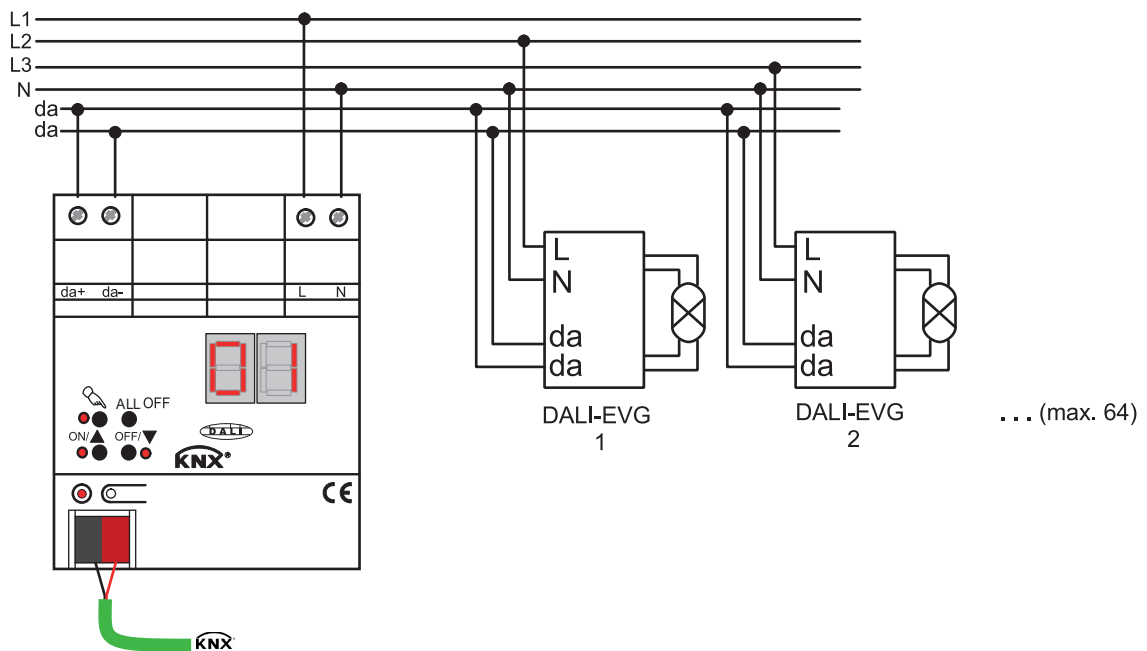

Figure 2: Electrical connection of mains voltage and the DALI interface

- Connect the mains voltage and the DALI system as shown in the connection example (figure 2).
- i** The DALI system voltage is a functional extra-low voltage (FELV). For this reason, the DALI interface should be treated as a cable able to carry voltage, in accordance with the installation instructions. The DALI Gateway supplies the system voltage (typ. DC 16 V). Carry out the installation work so that, when a DALI area is disconnected, all the mains voltages of the connected DALI operating device and the mains voltage supply of the DALI Gateway are switched off.
- i** DALI devices (max.64) can be connected to various phase conductors (L1, L2, L3).

- i** For reasons of clarity during installation, we recommend observing the polarity of the DALI cable. Observance of the DALI polarity is always dependent on the DALI operating devices being used.
- If multiple circuit breakers supply dangerous voltages to the device or load, couple the miniature circuit breakers or label them with a warning, to ensure disconnection is guaranteed.
- Connect bus line with connecting terminal.

Removing other operating units

DALI subscribers of some manufacturers have extended functions (operation with mains voltage on the DALI connection). When using the DALI Gateway as a control unit in the DALI system, any other control sections must be removed from the installation - particularly when refitting existing systems.

- Remove all the appropriate operating units, or ensure that there are no other control sections (figure 3).

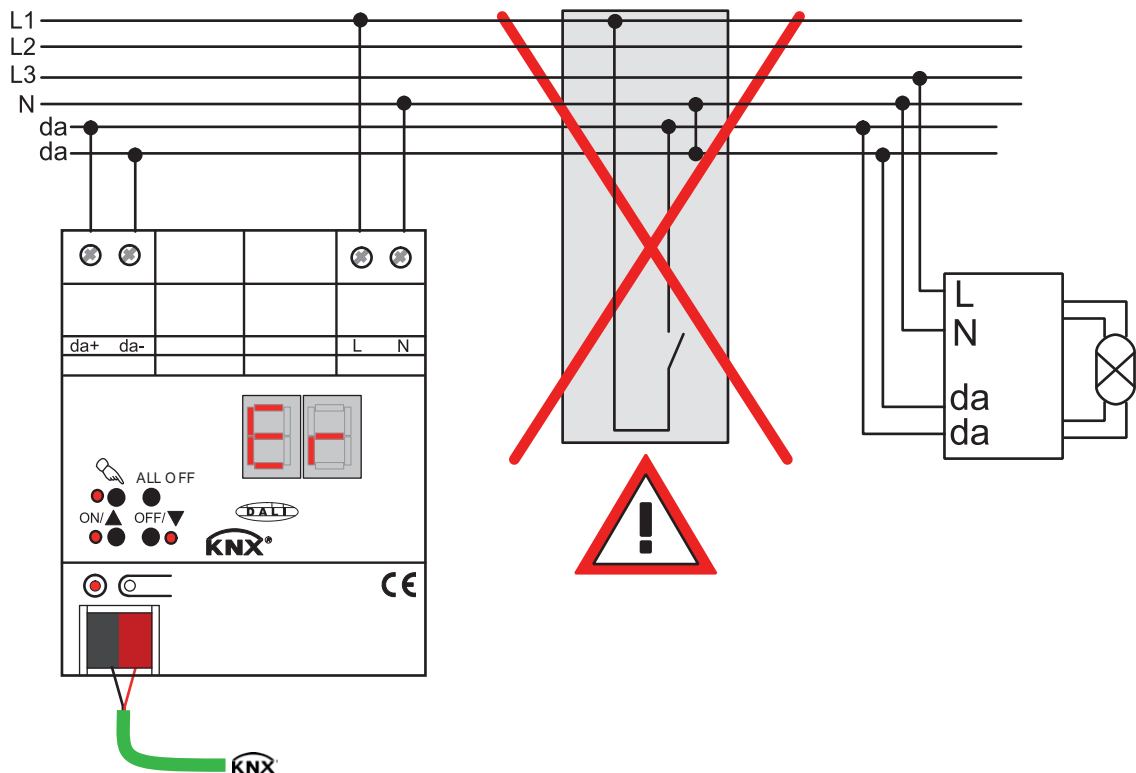

Figure 3: Removing other operating units in the DALI system

- i** Other control sections could be, for example, DALI central units, DALI potentiometers or comparable control components. These control sections must also be removed from the DALI system, in order to avoid system conflicts.
- i** The DALI Gateway supplies the DALI system voltage. For this reason, it is not permitted to integrate an additional DALI power supply into the installation, in parallel to the Gateway.
- i** Only one DALI Gateway may be operated in a closed DALI system.

- i** If the DALI Gateway detects mains voltage on the DALI connection (da+ and da- terminals), then it will cease operation and signal **Er** in the LED display.

Operation in emergency lighting systems

The device can be used in centrally-powered emergency lighting systems.

- i** **The statutory and standard specifications vary from country to country. In any event, the user / technical planner should check whether the specific specifications should be maintained.**

Depending on the scope of functions of the system, only the emergency lights are supplied by the central safety power supply (figure 4), or also the KNX system (figure 5), or, as a recommended alternative, additionally by the DALI Gateway (figure 6). In the latter case, in emergency operation, the DALI gateway can transmit the appropriate fault messages to a central system and other DALI gateways in the system.

- i** Observe the number of DALI devices in the emergency luminaires used.
- i** The chapter "Software Description" of this product documentation describes the exact function of the individual connection variants of the DALI Gateway in detail, along with the necessary configuration.

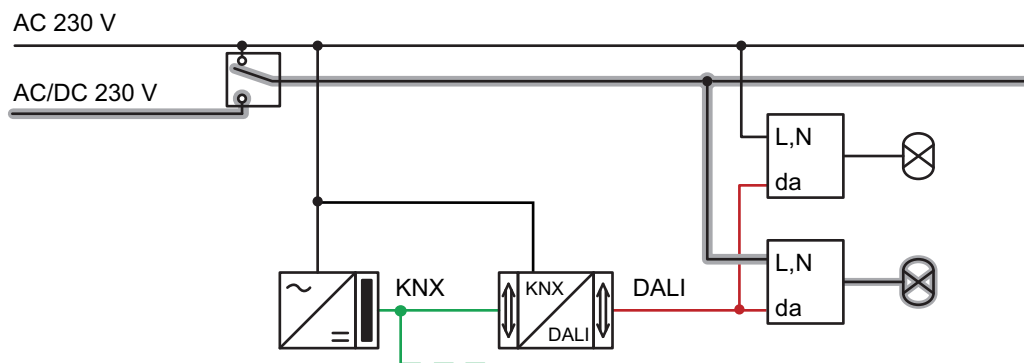

Figure 4: Electrical connection diagram in an emergency lighting system - Only DALI emergency lights integrated into the emergency power supply

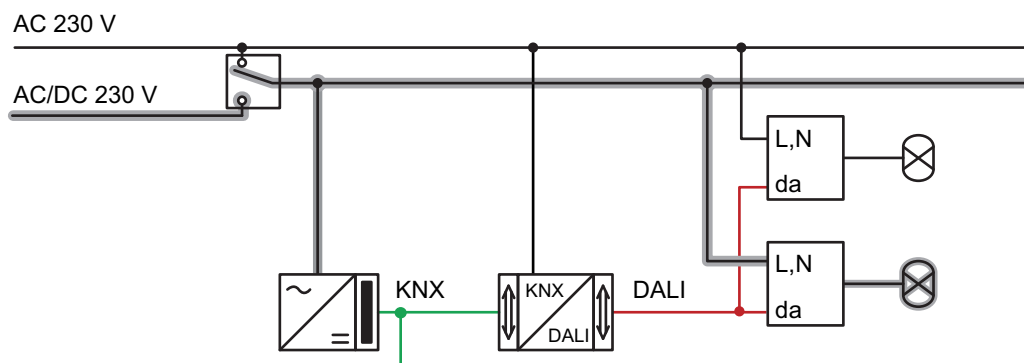

Figure 5: Electrical connection diagram in an emergency lighting system - KNX power supply and DALI emergency lights integrated into the emergency power supply

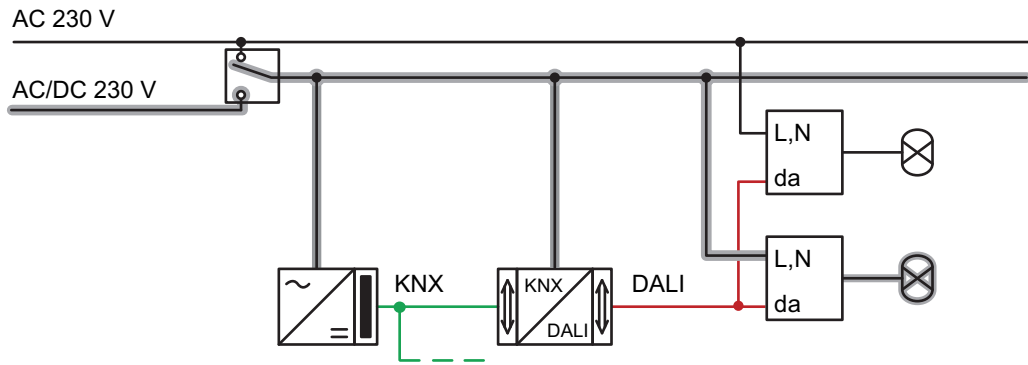

Figure 6: Electrical connection diagram in an emergency lighting system - KNX power supply, DALI emergency lights and DALI Gateway integrated into the emergency power supply (recommended installation)

Installing / removing the protective cap

To protect the bus lines against hazardous voltages in the area of the connecting terminals, a protective cap can be installed. The cap is installed with the bus terminal in place and the connected bus line led out at the rear (figure 7).

- To install the cap: Slide the cap over the bus connecting terminal until it is heard to engage.
- To remove the cap: Remove the cap by pressing the sides slightly and by pulling it out to the front.

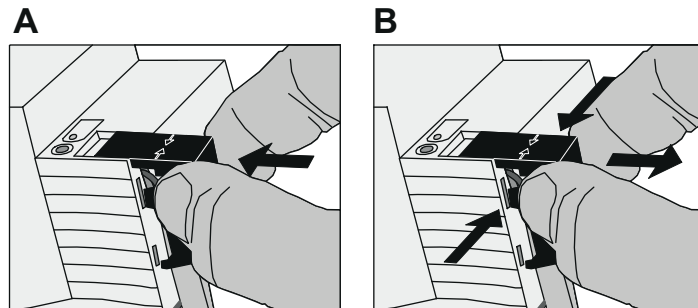

Figure 7: Installing / removing the protective cap

2.4 Commissioning

The device can be put into operation, after mounting of the device Gateway and connection of the bus line, the mains supply and the DALI cables. The following procedure is generally recommended...



DANGER!

Electrical shock when live parts are touched.

Electrical shocks can be fatal.

Before working on the device, disconnect the power supply and cover up live parts in the working environment.

Commissioning the device

- Switch on the mains supply of the Gateway.
- Switch on the bus voltage.

Voltage check: When the programming button is pressed, the red programming LED must light up.

- Configure and program the physical address with the help of the ETS.
- The DALI Gateway is configured using a plug-in embedded in the ETS database. Start the plug-in (open the Parameter view) and configure the KNX groups (cf. Chapter 4 "Software Description"). Do not carry out any DALI commissioning yet.
- Close the plug-in and download the application program using the ETS.
- Restart the plug-in (open the Parameter view) and carry out DALI commissioning (cf. Chapter 4 "Software Description").
- Close the plug-in to save the DALI configuration in the ETS database. Then, download the application program again using the ETS.

The DALI Gateway is ready for operation.

- i** It is not explicitly necessary to carry out DALI commissioning and reprogram the application program, if the DALI Gateway has been integrated into an existing DALI installation (e.g. on replacing an old device) and continues to be used with an unchanged DALI configuration (same short addresses, device types, group assignments, etc.). This is the case, for example, if a device is copied unchanged in the ETS project design or an XML template is imported.
- i** No ETS programming is possible if no mains voltage supply is connected to the DALI Gateway.
- i** On closing, the ETS plug-in indicates whether the ETS must reprogram the application program of the DALI Gateway.

2.5 Operation

The DALI Gateway offers manual operation to control the switching status and brightness of all programmed light groups and single devices. The button field with 4 function keys and 3 status LEDs on the front panel of the device can be used for setting the following modes of operation...

- Bus control: operation from touch sensors or other bus devices
 - Temporary manual control: manual control locally with keypad, automatic return to bus control,
 - Permanent manual control: local manual control with keypad.
- i** The operating modes can be enabled or disabled by parameter settings in the ETS.
 - i** In manual operation, the groups or single devices cannot be controlled via the bus.
 - i** Manual operation is possible only when the mains voltage supply to the Gateway is switched on. Manual operation ends in case of bus voltage failure, bus voltage return or mains voltage failure. Manual operation in broadcast mode (unprogrammed DALI Gateway) cannot be terminated by a bus voltage failure/bus voltage return.
 - i** In manual mode, bus operation can be disabled via a telegram. Manual operation is terminated on activation of the disabling function.
 - i** The colour temperature of a DALI group or single device cannot be changed by manual operation.
 - i** Further details concerning manual operation, especially with respect to the possible parameter settings and the interaction with other functions of the Gateway can be found in chapter "Software description" of this product documentation.

Controls and indicators for manual control

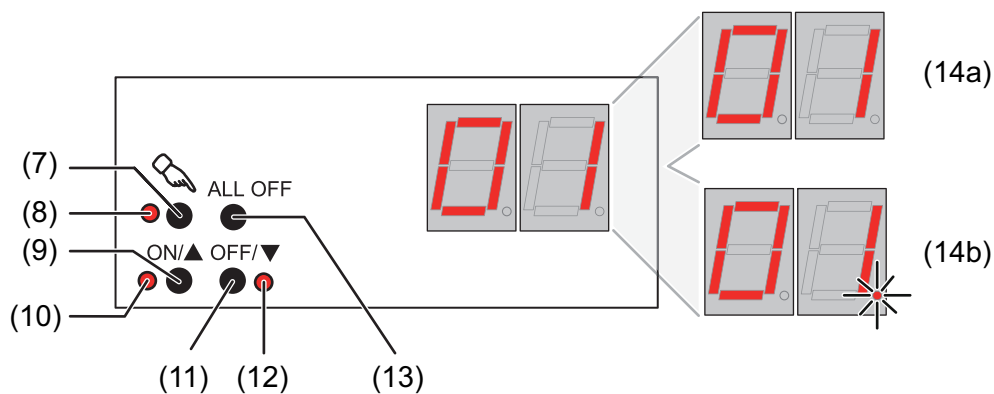

Figure 8: Controls and indicators for manual control

- (7) Button : Activation / deactivation of manual control.
- (8) LED : LED ON indicates permanent manual control.
- (9) Button **ON/ ▲**: Brief press: Group/single device ON / Sustained press: Increase brightness of group/single device.
- (10) Status LED **ON/ ▲**: LED ON in manual operation indicates a switched-on group/single device (brightness: 1... 100 %).

- (11) Button **OFF/ ▼**:
Brief press: Group/single device OFF / Sustained press: Decrease brightness of group/single device.
- (12) Status LED **OFF/ ▼**:
LED ON in manual operation indicates a switched-off group/single device (brightness: 0 %).
- (13) Button **ALL OFF**:
All DALI subscribers OFF (only in permanent manual operation).
- (14) 7-segment display to show the number of a DALI group (14a) or a single device (14b) selected by manual operation. Disabled in bus operation. In addition, to display additional information:

- -: Signals DALI commissioning phase or delay after an ETS programming operation or mains voltage return.

bc: Display during manual operation in an unprogrammed status (broadcast operation).

Er: Displaying an impermissible external voltage on the DALI device connection terminals (e.g. mains voltage connected). DALI Gateway without function. The Gateway is only ready for operation again when the error has been eliminated and initialisation has been performed again (mains voltage return).

LE: Signals automatic device replacement.

E: Signals an error during automatic device replacement.

Priorities

The DALI Gateway distinguishes between different functions that can have an effect on a DALI Group. In order to prevent conflicting output states, each available function has a certain priority. The function with the higher priority overrides the one with the lower priority.

- 1st priority: manual control (highest priority)
- 2nd priority: Emergency operation
- 3rd priority: Forced position function or disabling function
- 4th priority: Direct bus operation ("switching" & "dimming" & "brightness" & "colour temperature" objects, scenes, effects, central function)

i The priority of the scene and effect function over the disabling or forced position functions of a group or a single device can be configured. Thus, it is possible for a scene recall or the start of an effect to override a disabling or forced position function. Alternatively, a scene or an effect can have a lower priority, meaning that disabling functions or forced positions cannot be overridden by a scene recall or the start of an effect.

Switch on brief broadcast manual operation

The broadcast manual operation can be used in the unprogrammed state of the DALI Gateway. As, in this case, missing ETS programming means that no group/individual configurations are stored in the device, the DALI Gateway, in manual operation, controls the connected DALI operating devices jointly via a broadcast command.

The DALI Gateway has not yet been programmed by the ETS.

- Press the  button briefly (< 1 second).
bc is displayed in the 7-segment display.

i After 5 seconds without a button being pressed, the Gateway deactivates broadcast handling.

- i** Broadcast operation is preset in the delivery state. It can also be reactivated at any time after a programming operation by the ETS by unloading the application program using the ETS.

Switch off brief broadcast manual operation

The DALI Gateway has not yet been programmed by the ETS. Temporary broadcast manual operation was activated.



- No button-press for 5 seconds
- or -
- Press  button.
- or -
- Switch off the mains voltage supply.

Temporary broadcast manual operation is terminated. The 7-segment display goes out.

- i** The state set via manual operation is not changed when broadcast manual operation is switched off.



Switching on permanent broadcast manual operation

The DALI Gateway has not yet been programmed by the ETS. No broadcast manual operation or temporary broadcast manual operation is activated.

- Press the  button for at least 5 seconds.
The status LED  is illuminated. **bc** is displayed in the 7-segment display. Permanent broadcast manual operation is active.

Switching off permanent broadcast manual operation

Permanent broadcast manual operation was active.

- Press  button for at least 5 seconds.
- or -
- Switch off the mains voltage supply.
Permanent broadcast manual operation is terminated. The Status LED  and the 7-segment display goes out.

- i** The state set via manual operation is not changed when permanent broadcast manual operation is switched off.

Operating DALI operating devices in broadcast manual operation

The DALI Gateway has not yet been programmed by the ETS. Broadcast manual operation (permanent or temporary) is activated.

- Operate the operating devices by pressing the **ON/▲** button or the **OFF/▼** button.
Brief: Joint switch-on/switch-off.
Long: Joint dim brighter/darker.
Long and release: Joint dimming stop.
All the connected DALI operating devices execute the corresponding commands immediately.

Switching off all the operating devices in broadcast manual operation

Permanent broadcast manual operation is active.

- Press the **ALL OFF** button.

All the connected DALI operating devices are shut off immediately (Brightness: 0 %). The operating devices are not locked. Joint activation is possible again after shutoff.

- i** The **ALL OFF** function is not available in temporary broadcast manual operation.

Switching on the temporary manual control

After the DALI Gateway has been programmed at least one by the ETS, at least one DALI group or at least one DALI single device is created and configured in the device. In this case, the created groups and single devices can be controlled individually through manual operation. Broadcast operation is then deactivated.

The DALI Gateway was programmed at least once before by the ETS.
Manual control is enabled in the ETS.

- Press the  button briefly (< 1 second).

In the 7-segment display, the group number **01** or the single device short address **01.** is displayed.



- i** After 5 seconds without a button-press, the Gateway returns automatically to bus operation.

- i** Broadcast operation is preset in the delivery state. It can also be reactivated at any time after a programming operation by the ETS by unloading the application program using the ETS.

Switching off temporary manual operation

Temporary manual control was activated.

- No button-press for 5 seconds
- or -

- Select all the groups and single devices one after another by a brief press of the  button. Thereafter, press the  button again,
- or -

- Switch the mains power supply off or reset the bus (bus voltage return).
Temporary manual control is terminated. The 7-segment display goes out.

- i** The state set via manual control is not changed when temporary manual control is switched off. If, however, a forced position or disabling function has been activated via the bus before or during manual operation, the DALI Gateway executes the disabling or forced reactions for the groups and single devices concerned.

Switching on permanent manual control

The DALI Gateway was programmed at least once before by the ETS.

Manual control is enabled in the ETS. Bus operation or temporary manual control is active.

- Press  button for at least 5 seconds.

The status LED  is illuminated. In the 7-segment display, the group number **01** or the single device short address **01.** is displayed. Permanent manual control is active:

Switching off permanent manual control

Permanent manual control is active.

- Press  button for at least 5 seconds.
- or -
 - Switch the mains power supply off or reset the bus (bus voltage return).
Permanent manual operation is terminated. The Status LED and the 7-segment display goes out.
- i** Depending on the configuration of the Gateway in the ETS, the groups and single devices will be set to the state last adjusted in the manual mode or to the brightness value internally tracked (direct operation, forced position / disabling function) when the permanent manual mode is shut off.

Operating DALI groups or single devices in manual mode

The DALI Gateway was programmed at least once before by the ETS.
Manual control (permanent or temporary) is activated.

- Select the desired group: Press the  button briefly (if necessary, repeatedly).
The 7-segment display shows the number of the selected DALI group or the number of the selected single device. The Status LEDs **ON/▲** (1...100 %) or **OFF/▼** (0 %) in the button field show the switching state.
- Operate the group or single device by pressing the **ON/▲** button or **OFF/▼** button.
Short: switch on/off.
Long: dim brighter/darker.
Long and release: Stop dimming.
The selected DALI group or the single device executes the corresponding commands immediately.

Switch off all groups and single devices

Permanent manual control is active:

- Press the **ALL OFF** button.
All groups and single devices are shut off immediately (Brightness: 0 %). The groups and single devices are not locked. Individual activation is possible again after shutoff.
- i** The **ALL OFF** function is not available in temporary manual operation.

Disabling bus control of individual groups and devices through manual operation

The DALI Gateway was programmed at least once before by the ETS.

Permanent manual control is active:

Disabling of the bus control mode must have been enabled in the ETS.

- Select the group or single device: Press the  button briefly (if necessary, repeatedly).
The 7-segment display shows the number of the selected DALI group or the number of the selected single device. The Status LEDs **ON/▲** (1...100 %) or **OFF/▼** (0 %) in the button field show the switching state.
 - Press the **ON/▲** and the **OFF/▼** buttons simultaneously for at least 5 seconds.
The appropriate group or single device is disabled (no bus operation is possible).
The 7-segment display flashes.
- i** To unlock, proceed in the same way.

- i** A group or single device that has been disabled in manual operation can thereafter only be operated in permanent manual operation.

Performing a DALI device replacement

After starting the automatic device replacement, the DALI Gateway is able to check the completeness of the previously operated DALI operating devices. If, for example, a defective DALI electronic ballast was removed by an installation engineer and replaced by a new one, the DALI Gateway is able to program the new electronic ballast with the programming data of the failed electronic ballast. This offers the option of replacing a failed DALI operating device through simple operation on the device and without configuration work in the ETS.

- i** When using the automatic device replacement, only operating devices of the same DALI type can be interchanged! If operating devices of another type are to be replaced, a complete DALI commissioning must be carried out using the ETS plug-in.

The DALI Gateway was programmed at least once before by the ETS.

Automatic device replacement must be enabled in the ETS.

Ensure that the bus and mains voltage (also to all DALI operating devices) is switched on.

It is important that the DALI system has been fully commissioned with DALI commissioning.

Only one DALI operating device may fail and be replaced.

The device must be in bus operation (no manual operation active).

- Press the  and the **ALL OFF** button simultaneously for approx. 10 seconds.
Automatic device replacement is activated. The length of the operation is dependent on the number of DALI operating devices in the system. During device replacement, the 7-segment display signals **LE** (Learn). The display goes out after a successful replacement operation.
- i** During device replacement, all the other functions of the DALI Gateway are stopped. During device replacement, the Gateway tracks all the received bus states and evaluates the most recently tracked values (switching, dimming, brightness value, scenes, effects, central function, forced position function, disabling function) normally at the end of automatic device replacement. An active forced position or disabling function is interrupted by device replacement and reactivated at the end of the replacement operation, if the functions have not been deactivated via the bus in the interim. The behaviour as at the beginning of the forced position or disabling function is not executed again.
- i** Ensure that only one DALI operating device is replaced in the manner described. If multiple electronic ballasts fail (possibly no mains voltage is switched on) and have been replaced, then the electronic ballasts cannot be identified clearly by the Gateway and not configured automatically. In this case, new DALI commissioning by the ETS plug-in is required.
- i** If an error has occurred during device replacement, the 7-segment display signals **E** (Error) for 3 seconds. Perform the operation again, taking the above conditions and information into account. This signalling also takes place if automatic device replacement was activated, without having replaced a DALI operating device previously.

3 Technical data

General

Test mark	KNX/EIB
Ambient temperature	-5 ... +45 °C
Storage/transport temperature	-25 ... +70 °C
Fitting width	72 mm / 4 modules

Supply

Rated voltage	AC 110 ... 240 V ~
Mains frequency	50 / 60 Hz
Rated voltage	DC 110 ... 240 V
Power consumption	max. 6 W
Power loss	max. 3 W

DALI

Rated voltage DALI	DC 16 V (typ.)
Current	typ. 128 mA, max. 200 mA for short periods
Number of DALI subscribers	max. 64
DALI transmission rate	1.2 kbit/s
DALI protocol	EN 62386
Cable type	Sheathed cable 230 V, e.g. NYM
Resistivity	max. 8 Ω
Resistivity (simple length)	max. 4 Ω
DALI cable lengths...	
with Ø 1.5 mm ²	max. 300 m
with Ø 1.0 mm ²	max. 238 m
with Ø 0.75 mm ²	max. 174 m
with Ø 0.5 mm ²	max. 116 m

Connection of power supply and DALI

Connection mode	Screw terminal
single stranded	0.5 ... 4 mm ²
Finely stranded without conductor sleeve	0.5 ... 4 mm ²
Finely stranded with conductor sleeve	0.5 ... 2.5 mm ²

KNX

KNX medium	TP 256
Commissioning mode	S-mode
Rated voltage KNX	DC 21 ... 32 V SELV
Current consumption KNX	4.5 ... 5.0 mA

4 Software description

4.1 Software specification

ETS search paths: - Illumination / Dimmer / DALI-Gateway TW
 Configuration: S-mode standard

Applications:

No.	Short description	Name	Version	from mask version
1	Language variant: <u>German</u>	DALI Gateway TW C02011	1.1 for ETS3, Version d onwards, ETS4 Version 4.2 onwards, and ETS5	SystemB (07B0)
2	Language variant: <u>English</u>	DALI Gateway TW C02012	1.2 for ETS3, Version d onwards, ETS4 Version 4.2 onwards, and ETS5	SystemB (07B0)
3	Language variant: <u>French</u>	DALI Gateway TW C02013	1.3 for ETS3, Version d onwards, ETS4 Version 4.2 onwards, and ETS5	SystemB (07B0)
4	Language variant: <u>Spanish</u>	DALI Gateway TW C02014	1.4 for ETS3, Version d onwards, ETS4 Version 4.2 onwards, and ETS5	SystemB (07B0)
5	Language variant: <u>Dutch</u>	DALI Gateway TW C02015	1.5 for ETS3, Version d onwards, ETS4 Version 4.2 onwards, and ETS5	SystemB (07B0)

6	Language variant: <u>Italian</u>	DALI Gateway TW C02016	1.6 for ETS3, Version d onwards, ETS4 Version 4.2 onwards, and ETS5	SystemB (07B0)
7	Language variant: <u>Russian</u>	DALI Gateway TW C02017	1.7 for ETS3, Version d onwards, ETS4 Version 4.2 onwards, and ETS5	SystemB (07B0)

4.2 Software "DALI Gateway C0201x"

4.2.1 Scope of functions

General:

- Switching and dimming of a maximum of 64 lights with a DALI operating device (e.g. electronic ballast).
- Up to 6 different addressing types allow group-orientated and individually-address control of DALI lights via KNX telegrams.
- Up to 32 independent DALI groups are available for group addressing. For alternative control, these can be supplemented with 64 individually-addressable DALI device channels, as necessary.
- Control support of DALI operating devices of the device type "Colour Control" (DALI Device Type 8) in the specific version "Tunable White (TW)". Colour temperature control via relative or absolute dimming as well as via scenes and effects. The colour temperature control is largely independent of the brightness control and luminaire used.
- Optional master control of all connected DALI components is possible (broadcast). This means that there is no need to commission DALI, meaning that lighting systems with few functions can be started up quickly and easily (simplified configuration without DALI commissioning).
- Manual operation of the groups and single devices independent of the bus (also building site operation possible with broadcast control). Control of the switching status and brightness.
- Feedback of DALI error status (1-byte or 2-byte according to the KNX standard) or DALI short-circuit and message that the supply voltage has failed.
- Central switching function.
- Collective feedback of all switching states possible.
- Incorporation of the groups and single devices into up to 16 light scenes.
- Integration of lights or light groups in the effect control for the implementation of dynamic light scenes. Up to 16 effects are available here, each with up to 16 effect steps. A timer is available if necessary, which means that individual effects can be started and stopped depending on the time and weekday.

Group and device functions:

- Each group and single device offers the full scope of functions without any restrictions. All channel-oriented functions can be parameterised separately for each group or single device. This feature permits independent and multi-functional control of the DALI operating devices.
- Feedback of switching and brightness value: Active (transmitting after changes or cyclically to the bus) or passive (object readout) feedback functions.
- Setting of the brightness limit values (minimum brightness, maximum brightness) possible.
- Dimming behaviour and dimming characteristics configurable.
- Lamp preserving switch on and switch off (soft ON or soft OFF).
- Disabling function, or alternatively, forced position function is configurable. During a disabling function, the flashing of lights and single devices is not possible.
- Timing functions (switch-on delay, switch-off delay, staircase lighting timer, also with pre-warning function).
- Operating hours counter
- DALI Power ON level (using parameter "Behaviour after bus voltage return") and DALI system failure level (using parameter "Behaviour in case of bus voltage failure") can be set. In emergency lighting operation, the DALI system failure level can also be configured separately.

- Behaviour in case of bus voltage failure and bus voltage return as well as after ETS programming can be preset (for brightness control).
- For DALI operating devices of the device type "Colour Control" (DALI Device Type 8) in the specific version "Tunable White (TW)": colour temperature control via absolute dimming (2-byte communication object, colour temperature value in "K") and relative dimming (4-bit communication object), parameterisable dimming behaviour, minimum and maximum colour temperature can be set, feedbacks for current and invalid colour temperature.

Operation of emergency lights:

- Integration of the device into the DALI emergency lighting systems. The DALI Gateway is able to integrate standard DALI operating devices for lighting control according to IEC 62386-101 (DALI System) and IEC 62386-102 (Control-Gear) into centrally-supplied emergency lighting systems as an emergency light.
- Scope of the centrally-supplied emergency operation can be configured (only emergency supply of the DALI system or, additionally, of the KNX system or, additionally, of the DALI Gateway).
- Monitoring for the failure of the general power supply ?
- Behaviour at the end of emergency operation can be set.
- Brightness and colour temperature (only with DT 8) can be set separately when emergency operation is active.

ETS plug-in:

- Easy DALI commissioning, without additional software components. The identification, addressing and assignment of DALI operating devices takes place in the DALI commissioning environment of the ETS plug-in.
- Offline DALI configuration: Assignment of single devices to groups also without programming connection to the device.
- The DALI short addresses can be influenced individually. With the addition of group and device names, unique naming of DALI operating devices is possible in this way.
- Optional testing of the DALI device types when assigning DALI operating devices to programmed groups or single devices. If testing is enabled, the plug-in compares, during assignment as part of commissioning, the device types determined by the operating devices with the specifications by the device type parameters. Assignment can only take place if there is agreement. This will prevent functional incompatibilities after commissioning.
- When using the tunable white colour temperature control, the usage and testing of the DALI device type is intended to be unchangeable.
- Compatibility mode to support non-DALI-conformant operating devices. This means that the commissioning process becomes distinctly more tolerant towards specific DALI commissioning parameters, which means that operating devices not fully compliant with the DALI specification can be commissioned, possibly subject to functional restrictions. In addition to this, a DALI telegram rate limit can be activated in the ETS plug-in, meaning that adaptation to non-DALI-conformant operating devices is possible.
- Partial DALI commissioning: When using this function, operating devices that have already been found during a DALI device search are retained even if these do not answer the Gateway (e.g. if the mains voltage supply of these operating devices is switched off or the DALI cable was disconnected). This allows DALI systems to be partially commissioned.
- Test function of all created DALI groups or individual DALI operating devices: Central switching ON/OFF, single device test (ON / OFF, brightness specifications, colour temperature specifications, device status), individual group test (switching, dimming) and scene and effect test.
- Export and import of a configuration template in XML format.
- Print function to create a configuration report (overview of group assignment or entire device configuration).

4.2.2 Notes on software

ETS project design and commissioning

For project design and commissioning of this device, we recommend using the ETS5. Project designing and commissioning of the device using ETS4 (from version 4.2) ETS3 from version "d" is also possible. Additional hardware or software is not required for the configuration and commissioning of the DALI Gateway.

Each language variant has its own version of the application program (for example: Version 1.1. = German, 1.2 = English).

Safe-state mode

If the device - for instance as a result of errors in the project design or during commissioning - does not work properly, the execution of the loaded application program can be halted by activating the safe-state mode. The safe-state mode does not permit control of the DALI operating devices via the KNX. Only broadcast manual operation can be activated. The Gateway remains passive in safe-state mode, since the application program is not being executed (state-of-execution: terminated). Only the system software is still functional so that the ETS diagnosis functions and also programming of the device continue to be possible.

Activating the safe-state mode

- Switch off the mains voltage supply.
- Wait about one minute.
- Press and hold down the programming button.
- Switch on the mains supply. Release the programming button only after the programming LED starts flashing slowly.

The safe-state mode is activated.

- i The safe-state mode can be terminated by switching off the mains voltage supply (again, wait approx. one minute) or by programming with the ETS.
- i The bus voltage does not have to be switched on to activate safe-state mode.
- i Even in safe-state mode, a brief press of the programming button can switch the programming mode on and off as usual. The programming LED then stops flashing, even though safe-state mode is still active. Safe-state mode must also first be exited, in order to restore normal operation of the DALI Gateway.

Unloading the application program

The application program can be unloaded with the ETS. In this case, only broadcast manual operation of the connected DALI operating devices is possible.

4.2.3 Object table

4.2.3.1 Objects for group and single devices

Function: Switching

Object	Function	Name	Type	DPT	Flag
 1...417...14-88	Switching	Group 1...32 / Single device 1...64	1-bit	1.001	C, W, -, (R) ¹

Description 1-bit object for switching on or off ("1" = switch on; "0" = switch off).

Function: Output, relative dimming brightness

Object	Function	Name	Type	DPT	Flag
 2...418...14-89	Dimming	Group 1...32 / Single device 1...64	4-bit	3.007	C, W, -, (R) ¹

Description 4-bit object for relative dimming of the brightness.

Function: Output, absolute dimming brightness

Object	Function	Name	Type	DPT	Flag
 3...419...14-90	Brightness value	Group 1...32 / Single device 1...64	1 bytes	5.001	C, W, -, (R) ¹

Description 1-byte object for predefining an absolute dimming value (brightness value 0...255) from the bus.

Function: Absolute dimming feedback of brightness

Object	Function	Name	Type	DPT	Flag
 4...420...14-91	Feedback Brightness value	Group 1...32 / Single device 1...64	1 bytes	5.001	C, -, (T), (R) ²

Description 1-byte object for feedback signalling of a set dimming value (brightness value 0...255) to the bus.

Function: Switching feedback

Object	Function	Name	Type	DPT	Flag
 5...421...14-92	Feedback Switching	Group 1...32 / Single device 1...64	1-bit	1.001	C, -, (T), (R) ²

Description 1-bit object for giving feedback on the switching state ("1" = Switched on, "0" = Switched off) to the bus.

1: For reading, the R-flag must be set. The last value written to the object via the bus will be read.

2: The communication flags are set automatically depending on the configuration. "T" flag for active object; "R" flag for passive object.

Function: Staircase function

Object	Function	Name	Type	DPT	Flag
 6... 422, ...14- 93	Staircase function start / stop	Group 1...32 / Single device 1...64	1-bit	1.010	C, W, -, (R) ¹

Description 1-bit object to activate or deactivate the switch-on time of the staircase function ("1" = switch-on / "0" = switch-off).

Function: Staircase function

Object	Function	Name	Type	DPT	Flag
 7... 423, ...14- 94	Staircase time Factor	Group 1...32 / Single device 1...64	1 bytes	5.010	C, W, -, (R) ¹

Description 1-byte object to specify a time factor for the switch-on time of the staircase function (value range: 0...255).

Function: Operating hours counter

Object	Function	Name	Type	DPT	Flag
 8... 424, ...14- 95	OHC start/limiting value ²	Group 1...32 / Single device 1...64	2 bytes	7.007	C, W, -, (R) ¹

Description 2-byte object for external specification of a limit value / starting value of the operating hours counter (value range: 0...65535).

Function: Operating hours counter

Object	Function	Name	Type	DPT	Flag
 9... 425, ...14- 96	OHC restart	Group 1...32 / Single device 1...64	1-bit	1.015	C, W, -, (R) ¹

Description 1-bit object for resetting the operating hours counter ("1" = restart, "0" = no reaction).

Function: Operating hours counter

Object	Function	Name	Type	DPT	Flag
 10... 426, ...14- 97	OHC value	Group 1...32 / Single device 1...64	2 bytes	7.007	C, -, T, (R) ³

Description 2-byte object to transmit or read out the current counter level of the operating hours counter.
If the bus voltage should fail, the value of the communication object is not lost and is actively transmitted to the bus after bus voltage return or an ETS programming operation. In the as-delivered state, the value is "0".

1: For reading, the R-flag must be set. The last value written to the object via the bus will be read.

2: Threshold value object or start value object depending on the configured counter type of the operating hours counter.

3: For reading, the R-flag must be set. The last value written to the object via the bus or by the device will be read.

Function: Operating hours counter

Object	Function	Name	Type	DPT	Flag
 11... 427, ...14- 98	OHC elapsed	Group 1...32 / Single device 1...64	1-bit	1.002	C, -, T, (R) ¹

Description 1-bit object to sign that the operating hours counter has elapsed (forwards counter = limit value reached / backwards counter = value "0" reached). With a message, the object value is actively transmitted to the bus ("1" = message active / "0" = message inactive).
If the bus voltage should fail, the value of the communication object is not lost and is actively transmitted to the bus after bus voltage return or an ETS programming operation.

Function: Disabling function

Object	Function	Name	Type	DPT	Flag
 12... 430, ...15- 01	Disabling	Group 1...32 / Single device 1...64	1-bit	1.003	C, W, -, (R) ²

Description 1-bit object for activation and deactivation of the disabling function (polarity configurable).

Function: Forced position function

Object	Function	Name	Type	DPT	Flag
 13... 431, ...15- 02	Forced position	Group 1...32 / Single device 1...64	2-bit	2.001	C, W, -, (R) ²

Description 2-bit object for activating or deactivating the forced position. The polarity is fixed by the telegram.

Function: Output, absolute dimming of colour temperature

Object	Function	Name	Type	DPT	Flag
 1547- ... 1675, ...19- 27	Absolute colour temperature(K)	Group 1...32 / Single device 1...64	2 bytes	7.600	C, W, -, (R) ²

Description 2-byte object for presetting an absolute colour temperature value within the limits of the minimum and maximum colour temperature (configurable) of the bus.

Function: Output, relative dimming of colour temperature

Object	Function	Name	Type	DPT	Flag
 1548- ... 1676, ...19- 28	Relative colour temperature	Group 1...32 / Single device 1...64	4-bit	3.007	C, W, -, (R) ²

Description 4-bit object for relative dimming of the colour temperature.

1: For reading, the R-flag must be set. The last value written to the object via the bus or by the device will be read.

2: For reading, the R-flag must be set. The last value written to the object via the bus will be read.

Function: Absolute dimming feedback of colour temperature

Object	Function	Name	Type	DPT	Flag
 1549- 1677, ...19- 29	FB absolute colour temper.(K)	Group 1...32 / Single device 1...64	2 bytes	7.600	C, -, (T), (R) ¹

Description 2-byte object for feedback signalling of a set colour temperature to the bus.

Function: Absolute dimming feedback of colour temperature

Object	Function	Name	Type	DPT	Flag
 1550- 1678, ...19- 30	RM invalid colour temp.	Group 1...32 / Single device 1...64	1-bit	1.001	C, -, (T), (R) ¹

Description 1-bit object for feedback signalling of an invalidly set colour temperature ("1" = colour temperature invalid, "0" = colour temperature valid) via the object "Absolute colour temperature (K)". A colour temperature set externally is invalid if this violates the set limits of the minimum and maximum colour temperature.
 After a device reset (ETS programming operation, mains voltage return), the status "valid colour temperature" is always transmitted if an object is actively transmitting.

1: The communication flags are set automatically depending on the configuration. "T" flag for active object; "R" flat for passive object.

4.2.3.2 Objects for scenes and effects

Function:	Scene function				
Object	Function	Name	Type	DPT	Flag
 1505	Extension input	Scenes	1 bytes	18.001	C, W, -, (R) ¹
Description	1-byte object for recalling scenes (Bit 7 deleted) or for storing new scene values (Bit 7 set). Bits 0...6 carry the configurable KNX scene number (0...63 -> KNX scene number 1...64).				

Function:	Effect control				
Object	Function	Name	Type	DPT	Flag
 1507- ...15- 22	Start / Stop	Effect 1...16	1-bit	1.010	C, W, -, (R) ¹
Description	1-bit object to start and stop individual effects ("1" = Start effect, "0" = Stop effect). Effects can run simultaneously and also influence each other, provided that the same groups, single devices or scenes are integrated in the effect steps.				

Function:	Effect control				
Object	Function	Name	Type	DPT	Flag
 1523	Extension input	Effects	1 bytes	18.001	C, W, -, (R) ¹
Description	1-bit object to start (Bit 7 deleted) and stop (Bit 7 set) individual effects. Bits 0...6 carry the configurable KNX effect number (0...63 -> KNX effect number 1...64).				

Function:	Effect control				
Object	Function	Name	Type	DPT	Flag
 1545	Time	Effects	3 bytes	10.001	C, W, -, (R) ¹
Description	3-byte object for providing the current time and current weekday for the timer function of the effect control. If no valid weekday is transmitted in the telegram, the timer executes the configured times for starting and stopping individual effects daily. This object is only available with the configured "3-byte" time data format!				

1: For reading, the R-flag must be set. The last value written to the object via the bus will be read.

Function: Effect control

Object	Function	Name	Type	DPT	Flag
 1546	Time / date	Effects	8 bytes	19.001	C, W, -, (R) ¹

Description Combined 8-byte object for providing the current time and current weekday for the timer function of the effect control.
 If no valid weekday is transmitted in the telegram, the timer executes the configured times for starting and stopping individual effects daily. The date transmitted in the telegram is not evaluated by the timer.
 This object is only available with the configured "8-byte" time data format!

Function: Effect control

Object	Function	Name	Type	DPT	Flag
 1931- ...19- 46	Disabling timer	Effect 1...16	1-bit	1.003	C, W, -, (R) ¹

Description 1-bit object for activating and deactivating the disabling function of an effect (polarity configurable).
 These objects are available if disabling functions of individual effects are enabled!

1: For reading, the R-flag must be set. The last value written to the object via the bus will be read.

4.2.3.3 Object for emergency lighting

Function:	Emergency lighting				
Object	Function	Name	Type	DPT	Flag
 1538	Failure of external supply	Emergency lighting	1-bit	1.002	C, W, -, (R) 1
Description	<p>Using this 1-bit object, a different KNX bus device (e.g. binary input) can inform the DALI Gateway that the general mains voltage supply has failed. With this, the Gateway then activates emergency operation. "1" = Mains voltage has failed, "0" = Mains voltage available. To allow telegram transmission and evaluation, the KNX system and the mains voltage supply of the DALI Gateway must be integrated in the central emergency power supply.</p>				

Function:	Emergency lighting				
Object	Function	Name	Type	DPT	Flag
 1539	Feedback Failure of supply	Emergency lighting	1-bit	1.002	C, -, T, (R) ²
Description	<p>Using this 1-bit object, the DALI Gateway can inform other bus devices that the general mains voltage supply has failed. According to the configuration, the Gateway obtains the information for this from the object "Failure, external supply" and/or from the internal failure message of the DALI system. Other bus devices evaluating this feedback (e.g. other KNX DALI Gateways) can then respond appropriately and also activate emergency operation. "1" = Mains voltage has failed, "0" = Mains voltage available. To allow telegram transmission and evaluation, the KNX system and the mains power supplies of the DALI Gateway must be integrated in the central emergency power supply.</p>				

Function:	Emergency lighting				
Object	Function	Name	Type	DPT	Flag
 1540	Emergency operation extern msg	Emergency lighting	1-bit	1.003	C, W, -, (R) 1
Description	<p>Using this 1-bit object, a different KNX bus device (e.g. another DALI Gateway -> link to the object "Feedback, supply failure") can inform the DALI Gateway that emergency operation has been activated. Through this, the Gateway then activates emergency operation, without having to identify the failure of the general mains voltage supply itself. "1" = Mains voltage has failed / Activate emergency operation, "0" = Mains voltage available / Deactivate emergency operation. To allow telegram transmission and evaluation, the KNX system and the mains voltage supply of the DALI Gateway must be integrated in the central emergency power supply.</p>				

1: For reading, the R-flag must be set. The last value written to the object via the bus will be read.

2: For reading, the R-flag must be set. The last value written to the object via the bus or by the device will be read.

Function: Emergency lighting

Object	Function	Name	Type	DPT	Flag
 1541	Feedbk emerg. operation status	Emergency lighting	1-bit	1.002	C, -, (T), (R) ¹

Description The DALI Gateway uses this 1-bit object to signal that emergency operation has been activated. This allows other KNX bus devices to be informed about emergency operation in order to control displays for users (e.g. in a visualisation) or to carry out further actions (e.g. remote forwarding via the telephone or IP data network through suitable KNX components).
 "1" = Emergency operation active, "0" = Emergency operation inactive.
 To allow telegram transmission and evaluation, the KNX system and the mains power supplies of the DALI Gateway must be integrated in the central emergency power supply.

Function: Emergency lighting

Object	Function	Name	Type	DPT	Flag
 1542	Feedback emerg. lights overall	Emergency lighting	1-bit	1.002	C, -, (T), (R) ¹

Description The DALI Gateway uses this 1-bit object to signalise the complete status of all DALI lights integrated into emergency operation. If the Gateway only detects a malfunction of only one operating device or of multiple operating devices, it will set the object value to "1". Otherwise (error-free system), the object value is set to "0". This allows the central display of the complete status of a DALI emergency lighting system, e.g. on a KNX visualisation, meaning that further analyses (e.g. evaluation of the error statuses) can be carried out. An error is also present when the Gateway can no longer set up communication to an operating device integrated in emergency operation.

1: The communication flags are set automatically depending on the configuration. "T" flag for active object; "R" flat for passive object.

4.2.3.4 Objects for general functions

Function:	DALI function monitoring				
Object	Function	Name	Type	DPT	Flag
 1524	Feedback	Error status in DALI system	1-bit	1.002	C, -, (T). (R) ¹
Description	1-bit object for global feedback of errors in the DALI system. The DALI Gateway polls the error status of all DALI operating devices cyclically. If it identifies an error, the object value of this object is set to "1". The object value is "0" if all the operating devices are working without errors. This allows the central display of the overall error status of a DALI system, e.g. on a KNX visualisation, meaning that further analyses (e.g. evaluation of the error status for each DALI operating device) can be carried out.				

Function:	DALI function monitoring				
Object	Function	Name	Type	DPT	Flag
 1525	Indication	Voltage failure in the DALI system	1-bit	1,005	C, -, T, (R) ²
Description	1-bit object for signalling a mains voltage failure on the DALI Gateway ("0" = Mains voltage available, "1" = Mains voltage failure).				

Function:	DALI function monitoring				
Object	Function	Name	Type	DPT	Flag
 1527	Indication	Short-circuit in the DALI system	1-bit	1,005	C, -, T, (R) ²
Description	1-bit object for signalling a short-circuit on the DALI cable ("0" = No short-circuit, "1" = Short-circuit).				

Function:	Central function				
Object	Function	Name	Type	DPT	Flag
 1528	Switching	Central function for groups and devices	1-bit	1.001	C, W, -, (R) ³
Description	1-bit object for central switching of assigned DALI groups and channels. The telegram polarity can be configured.				

1: The communication flags are set automatically depending on the configuration. "T" flag for active object; "R" flag for passive object.

2: For reading, the R-flag must be set. The last value written to the object via the bus or by the device will be read.

3: For reading, the R-flag must be set. The last value written to the object via the bus will be read.

Function: Manual operation

Object	Function	Name	Type	DPT	Flag
 1529	Disabling	Manual operation	1-bit	1.003	C, W, -, (R) ¹

Description 1-bit object for disabling the buttons for manual control on the device. The telegram polarity can be configured.

Function: Manual operation

Object	Function	Name	Type	DPT	Flag
 1530	Status	Manual operation	1-bit	1.002	C, -, T, (R) ²

Description 1-bit object for manual control status transmission. The object is "0", when manual control is deactivated (bus control). The object is "1", when manual control is being activated. You can configure whether the temporary or the permanent manual control will be indicated as status information or not.

Function: Status signal

Object	Function	Name	Type	DPT	Flag
 1531	Feedback	Standby switch off DALI/Global switching status	1-bit	1.001	C, -, (T), (R) ³

Description 1-bit object for global feedback of the switching status of all planned DALI groups and devices. The object value is "1" if at least one DALI group or one DALI single device is switched on (brightness value > 0). The object value is "0" if all the DALI groups or DALI single devices are switched off (brightness value = 0).
 Optionally, the object value can be evaluated and transmitted after a delay. If the delay time is used, this object can be used for standby switch-off of the DALI system. For this, this object can be connected, for example, to a KNX switching actuator, which switches the mains power supply of all the DALI operating devices (not of the DALI Gateway!). If the global switching status is "0", the actuator will disconnect all the operating devices from the network, saving electrical energy. The mains voltage is switched on automatically, as soon as the Gateway is to switch on at least one operating device by DALI command. The time between the transmission of this feedback (switching on the mains voltage) and the transmission of the DALI command can be configured in the ETS (time to restart the DALI devices).

1: For reading, the R-flag must be set. The last value written to the object via the bus will be read.

2: For reading, the R-flag must be set. The last value written to the object via the bus or by the device will be read.

3: The communication flags are set automatically depending on the configuration. "T" flag for active object; "R" flag for passive object.

Function: Collective feedback

Object	Function	Name	Type	DPT	Flag
 1532	Feedback switching status	Collective feedback groups 1-16	4 bytes	27,001	C, -, (T), (R) ¹

Description 4-byte object for collective feedback of individual switching states. The collective feedback summarises the switching status of the DALI groups 1...16 in just one telegram. The object contains bit-orientated feedback information of these individual groups.
This object is only visible if the addressing type set in the ETS allows for group control.

Function: Collective feedback

Object	Function	Name	Type	DPT	Flag
 1533	Feedback switching status	Collective feedback groups 17-32	4 bytes	27.001	C, -, (T), (R) ¹

Description 4-byte object for collective feedback of individual switching states. The collective feedback summarises the switching states of the DALI groups 17...32 in just one telegram. The object contains bit-orientated feedback information of these individual groups.
This object is only visible if the addressing type set in the ETS allows for group control 1-32.

Function: Collective feedback

Object	Function	Name	Type	DPT	Flag
 1534	Feedback switching status	Collective feedback single devices 1-16	4 bytes	27.001	C, -, (T), (R) ¹

Description 4-byte object for collective feedback of individual switching states. The collective feedback summarises the switching status of the DALI single devices 1...16 in just one telegram. The object contains bit-orientated feedback information of these single devices.
This object is only visible if the addressing type set in the ETS allows for single device control.

Function: Collective feedback

Object	Function	Name	Type	DPT	Flag
 1535	Feedback switching status	Collective feedback single devices 17-32	4 bytes	27.001	C, -, (T), (R) ¹

Description 4-byte object for collective feedback of individual switching states. The collective feedback summarises the switching states of the DALI single devices 17...32 in just one telegram. The object contains bit-orientated feedback information of these single devices.
This object is only visible if the addressing type set in the ETS allows for single device control.

1: The communication flags are set automatically depending on the configuration. "T" flag for active object; "R" flag for passive object.

 Function: Collective feedback

Object	Function	Name	Type	DPT	Flag
 1536	Feedback switching status	Collective feedback single devices33-48	4 bytes	27.001	C, -, (T), (R) ¹

Description 4-byte object for collective feedback of individual switching states. The collective feedback summarises the switching status of the DALI single devices 33...48 in just one telegram. The object contains bit-orientated feedback information of these single devices.
This object is only visible if the addressing type set in the ETS allows for single device control.

 Function: Collective feedback

Object	Function	Name	Type	DPT	Flag
 1537	Feedback switching status	Collective feedback single devices49-64	4 bytes	27.001	C, -, (T), (R) ¹

Description 4-byte object for collective feedback of individual switching states. The collective feedback summarises the switching status of the DALI single devices 49...64 in just one telegram. The object contains bit-orientated feedback information of these single devices.
This object is only visible if the addressing type set in the ETS allows for single device control.

 Function: DALI function monitoring

Object	Function	Name	Type	DPT	Flag
 1543	Feedback	Error status per DALI operating device	1 bytes	238.60-0	C, W, T, (R) ^{2,3}

Description 1-byte object to transmit and read out the error status of individual DALI operating devices connected to the system. The following bit assignment is used:
 Bit 0...5: Number of the DALI operating device (0...63)
 Bit 6: Lamp error ("0" = No error, "1" = Error)
 Bit 7: Electronic ballast error ("0" = No error, "1" = Error)
 When operating as a passive status object, this object can always receive telegrams (ValueWrite) as a transmission request. A received telegram is answered immediately by this object (ValueWrite) by transmitting the queried error status as an answer. In the query telegram, Bits 0...5 must contain the number of the electronic ballast (number of electronic ballast error status = short address - 1). Bits 6 and 7 must be set to "1". Otherwise, the query telegram will be ignored.

1: The communication flags are set automatically depending on the configuration. "T" flag for active object; "R" flag for passive object.

2: The communication flags are set automatically depending on the configuration. "T" flag for active object; "S" and "T" flag for passive object.

3: For reading, the R-flag must be set. The last value written to the object via the bus or by the device will be read.

Function: DALI function monitoring

Object	Function	Name	Type	DPT	Flag
 1544	Feedback	KNX error status per DALI operating device	2 bytes	237.60-0	C, W, T, (R) ^{1,2}

Description

2-byte object to transmit and read out the error status of individual DALI operating devices connected to the system, according to the KNX standard. The error states of all the devices of a DALI group can also be transferred or read out collectively. The following bit assignment is used:

- Bit 0...5: Number of the DALI operating device (0...63) or of the DALI group (0...15).
- Bit 6: Address bit ("0" = Individual operating device addressed, "1" = Group addressed)
- Bit 7: Transmission request ("0" = No transmission request / Response or spontaneous telegram, "1" = Transmission request)
- Bit 8: Lamp error ("0" = No error, "1" = Error)
- Bit 9: Electronic ballast error ("0" = No error, "1" = Error)
- Bit 10: Converter error ("0" = No error, "1" = Error)

When operating as a passive status object, this object can always receive telegrams (ValueWrite) as a transmission request (Bit 7 = "1"). A received telegram is answered immediately by this object (ValueWrite) by transmitting the queried error status as an answer. In the query telegram, Bits 0...5 must contain the number of the electronic ballast (number of electronic ballast error status = short address - 1) or that of the group (number of group error status = DALI group number - 1). Bit 6 must show whether this is single device addressing or group addressing. The states of Bits 8...10 in the transmission request are irrelevant.

1: The communication flags are set automatically depending on the configuration. "T" flag for active object; "S" and "T" flag for passive object.

2: For reading, the R-flag must be set. The last value written to the object via the bus or by the device will be read.

4.2.4 Functional description

4.2.4.1 Application basics

4.2.4.1.1 DALI system and addressing types

DALI system

The DALI Gateway forms the interface between a KNX building installation and a DALI (**D**igital **A**ddressable **L**ighting **I**nterface) lighting system. Usually, DALI systems are room-orientated and cover high functional light management requirements, for example in offices, training or conference rooms. With these applications, it is often necessary also to integrate the room-orientated DALI system into the multi-building KNX device technology. In this way, not only the control of the DALI light system using KNX sensor components becomes possible, but also the integration of the building-side blind, heating and air conditioning systems into the light management.

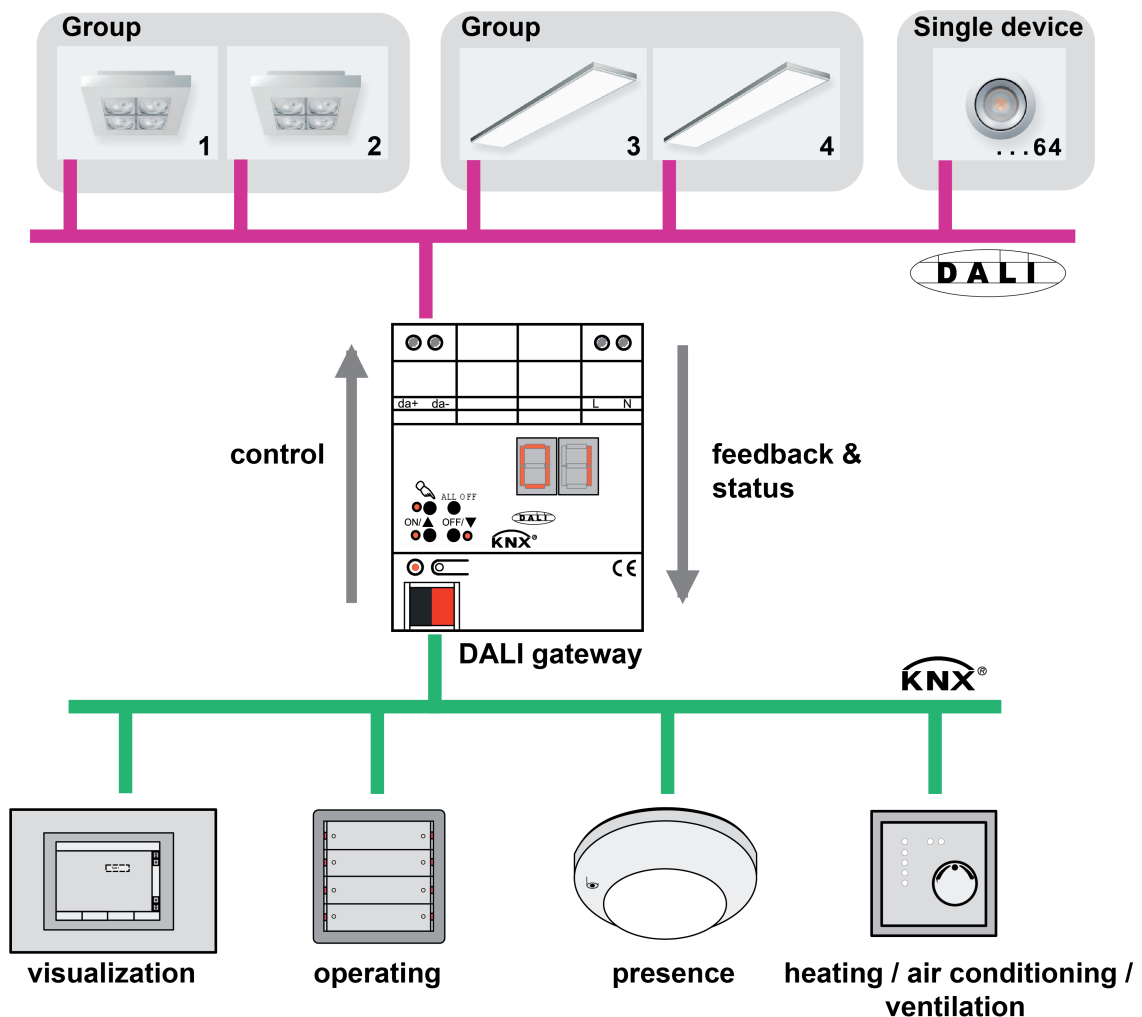

Figure 9: Principle overview of a KNX-DALI system integration (example)

Within the system, the DALI Gateway functions as a master control component (master controller), which also guarantees the power supply of the DALI interface. The DALI operating devices, e.g. DALI electronic ballasts, work as command receivers (slaves), which only return states or status messages to the master on request. It is the sole task of the DALI Gateway to transmit control commands received from the KNX onto the DALI cable and to check the operating devices. The use of additional DALI control components in multimaster operation, for

example an additional DALI central unit, a DALI potentiometer or push-buttons switching mains voltage, is superfluous and can, individual cases, lead to malfunctions in the DALI system. For this reason, it is necessary to remove other control components from the system, particularly when refitting existing DALI systems. The DALI system is then fully controlled by components of the KNX.

Communication between the KNX system and the DALI interface takes place bidirectionally via the DALI Gateway. On the one hand, the Gateway receives telegrams from the KNX, which either influence the brightness status of a DALI group or of individual operating devices directly (e.g. through switching, dimming, brightness value specification or scene recall) or adjust it indirectly (e.g. through time, disabling or forced position functions or by recalling effects). Internally, the DALI Gateway always determines the current brightness states of the groups and single devices and forwards brightness commands to the DALI operating devices, which then set themselves to the appropriate brightness. On the other hand, the internally-tracked switching or brightness states of the groups and single devices can be fed back to the KNX. The transfer of the status information of the DALI operating devices (lamp error, electronic ballast error) or the Gateway (mains voltage failure, DALI short-circuit, emergency operation) to the bus is possible.

The DALI Gateway supports the control of DALI operating devices of the device type "Colour Control" (DALI Device Type 8) in the specific version "Tunable White (TW)". This makes it possible to also control the colour temperature of a DALI lamp by means of suitable DALI operating devices and luminaires. The Gateway allows the colour temperature control via relative or absolute dimming. The colour temperature control is largely independent of the brightness control and luminaire used.

Groups or single devices can be optionally integrated into 16 independent scenes. Within a scene, brightness values can be configured separately in the ETS for each DALI group or for individual brightness values and colour temperatures or adjusted at any time later during operation using scene memory telegrams.

In particular, for the implementation of dynamic light scenes, it is possible to include lights or light groups in the effect control of the DALI Gateway. Up to 16 effects are available here, each with up to 16 effect steps. Each effect step represents an individual light scene. Time-controlled toggling of the effect steps makes the overall effect dynamic. Brightness and colour temperature sequences can be implemented using one or more DALI groups, but also using individual DALI devices or scenes.

Addressing types

A DALI system can address a maximum of 64 operating devices, although the Gateway itself does not count as an operating device. Up to 6 different addressing types allow group-orientated and individually-address control of DALI lights via KNX telegrams. Depending on the configuration, up to 32 independent DALI groups are available for group addressing. For alternative control, these can be supplemented with 64 individually-addressable DALI device channels, as necessary...

- Master control:
With master control, all the connected DALI components are controlled by a broadcast command (figure 10). This means that there is no need to commission DALI, meaning that lighting systems with few functions can be started up quickly and easily (simplified configuration without DALI commissioning). With central addressing, some functions are not available (no emergency lights can be contacted, no error status read out, no collective feedback).

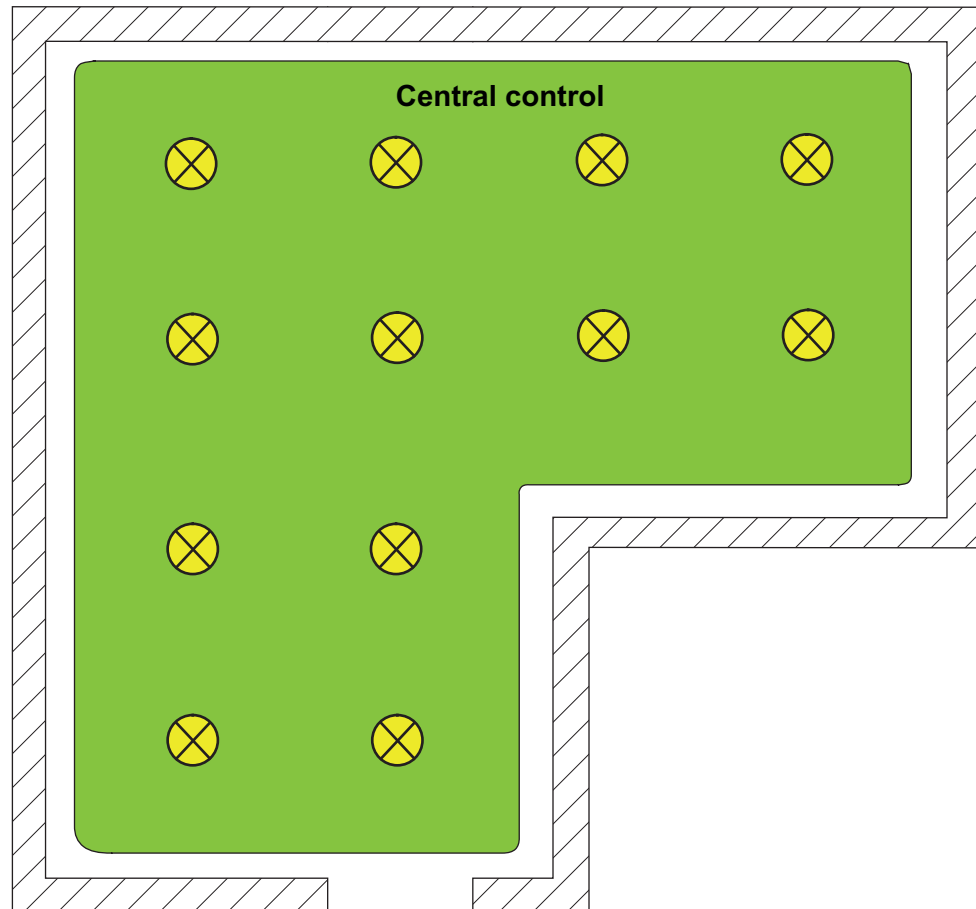

Figure 10: Example of a master control (broadcast) - Only one group

- Group control 1...16:
 During DALI commissioning or offline configuration, the max. 64 DALI operating devices are assigned to any different groups of the Gateway. For this any number of DALI operating devices can be assigned to each group (1...16).
 On the DALI side, addressing takes place using group addresses, which the Gateway configures invisibly for the user and manages on its own. During DALI commissioning, the operating devices concerned are automatically programmed accordingly. Through the use of group addresses (multicast), the reaction time of the DALI subscribers in this type of addressing is short - particularly in large-scale systems.
 In the planning example (figure 11), each of the lights shown has a DALI operating device. Four lights are in the same group. The lights combined in this way can be controlled jointly using the KNX.

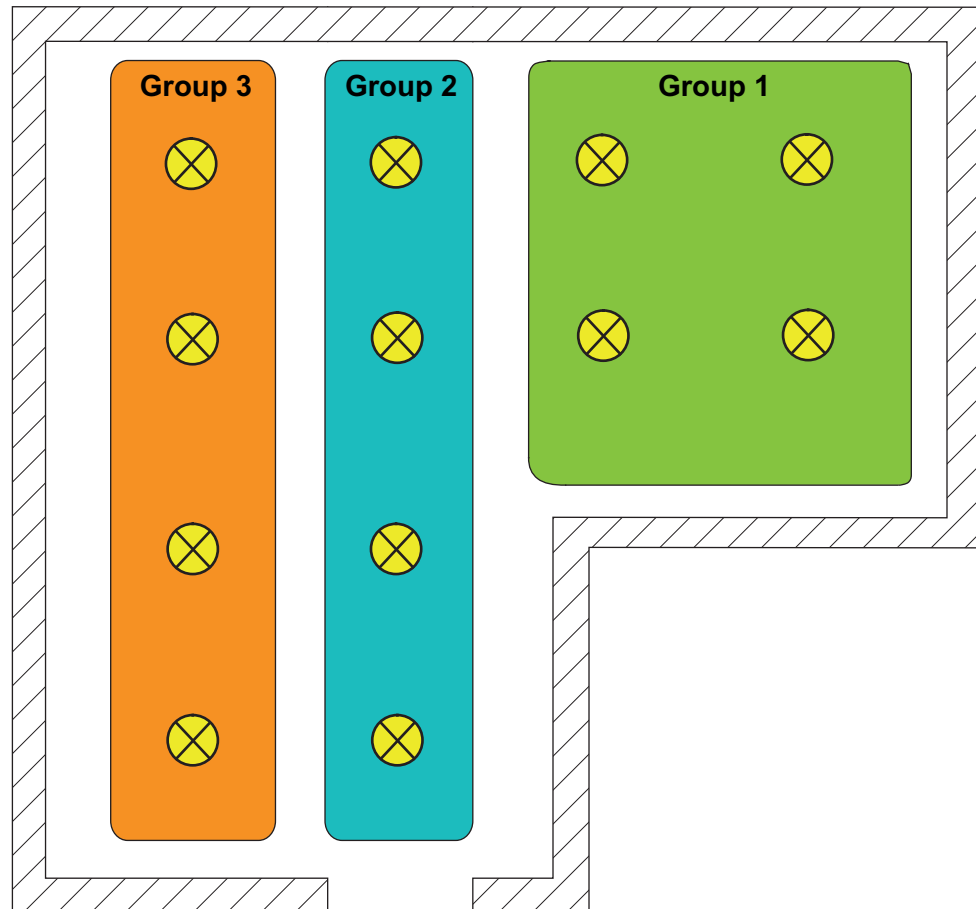

Figure 11: Example of group control with three groups - all lights with group addressing

- Group control 1...32:
 In this addressing type too, during DALI commissioning or offline configuration, the max. 64 DALI operating devices are assigned to different groups of the Gateway. For this, any number of DALI operating devices can be assigned to groups 1...16. On the DALI side, addressing takes place using group addresses, meaning that the reaction time of the DALI subscribers in groups 1...16 is short.
 In contrast, only up to two DALI operating devices can be assigned to groups 17...32. Since there are no DALI group addresses for these groups, DALI addressing takes place using the device short addresses, which means that the operating devices are addressed, and thus contacted, individually. In particular, in large systems with multiple subscribers addressed by short address, the reaction time is slower than with group addressing, as addressing takes place individually and in sequence.
 In the planning example (figure 12), each of the lights shown has a DALI operating device. In the right-hand and middle areas of the room are two groups, each with four lights. Here, use of groups 1...16 is advisable. In another area of the room, a total of four lights is integrated into two further groups. Each of these groups contains two lights. Here, use of groups 17...32 is advisable, in particular if the lower groups are to comprise multiple operating devices (e.g. in other rooms). When integrating up to two lights into a group, it is wise to use groups 17...32, provided that no fast reaction times are expected.
 If this addressing type is used, the integration of two operating devices each in up to 32 groups allows addressing of 64 subscribers via group control.

- i** The device short addresses are always assigned in the parameter configuration of the single devices and can thus be influenced. Short addresses must be unique. This means that addresses may not appear multiple times in a DALI system. The ETS plug-in of the DALI Gateway checks the editing of short addresses and checks that they are unique.

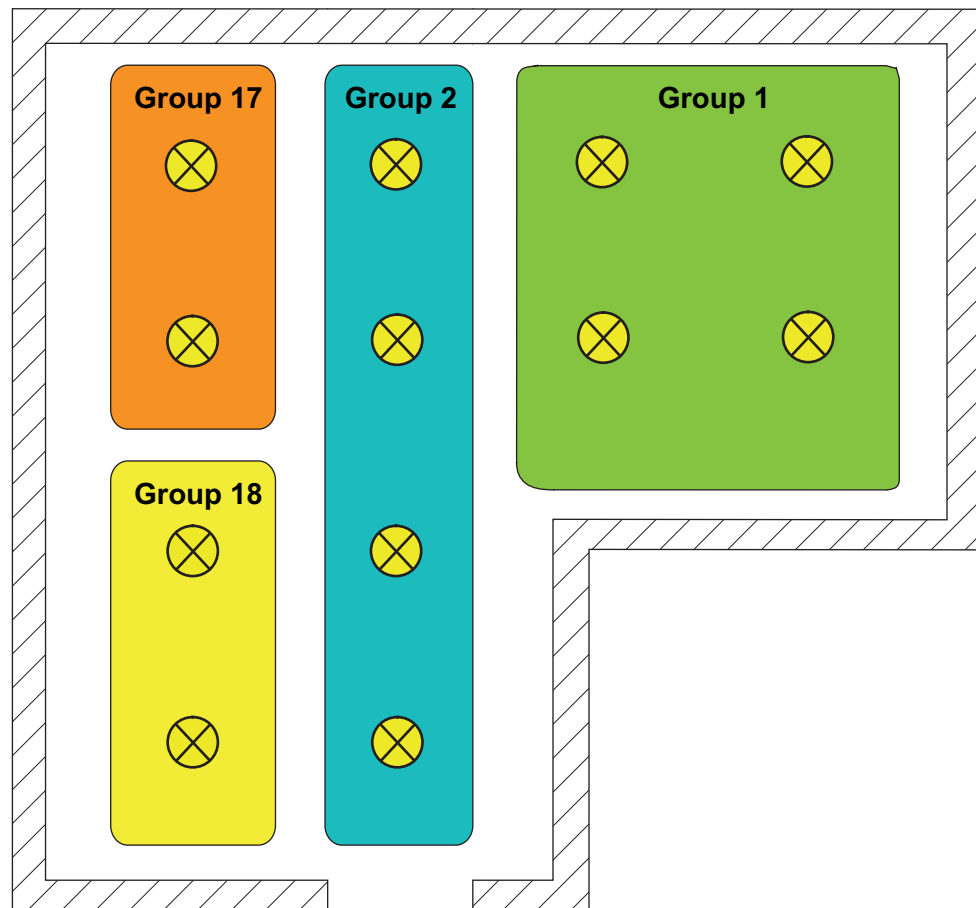

Figure 12: Example of group control with four groups -
Lights in groups 17 and 18 with individual addresses

- Group control 1...16 and group control 1...64:
In this addressing type, the operating devices in groups 1...16 are controlled using DALI group addresses, as described above for group control. In addition, other DALI operating devices can be addressed individually as single devices. The addressing of these devices takes place individually using the device short addresses.
In the planning example (figure 13), each of the lights shown has a DALI operating device. In the right-hand and middle areas of the room are two groups. Here, use of groups 1...16 is advisable. In another area of the room, two more lights are installed, each of which is to be controlled separately. Here, use of single addressing is advisable.
- i** DALI operating devices can either be integrated only in single device addressing, or alternatively, in group addressing. It is not possible to control an operating device with both addressing types. Operating devices integrated in group control can no longer be addressed as a single device. The reverse case applies in the same manner.

- i** In particular, in large systems with multiple individual subscribers, the reaction time is slower than with pure group control, as addressing takes place individually and in sequence. If multiple DALI operating devices are to react identically to KNX commands (simultaneous switch-on or switch-off, identical brightness specifications), then - if possible - group addressing or scene control of these subscribers is preferable.

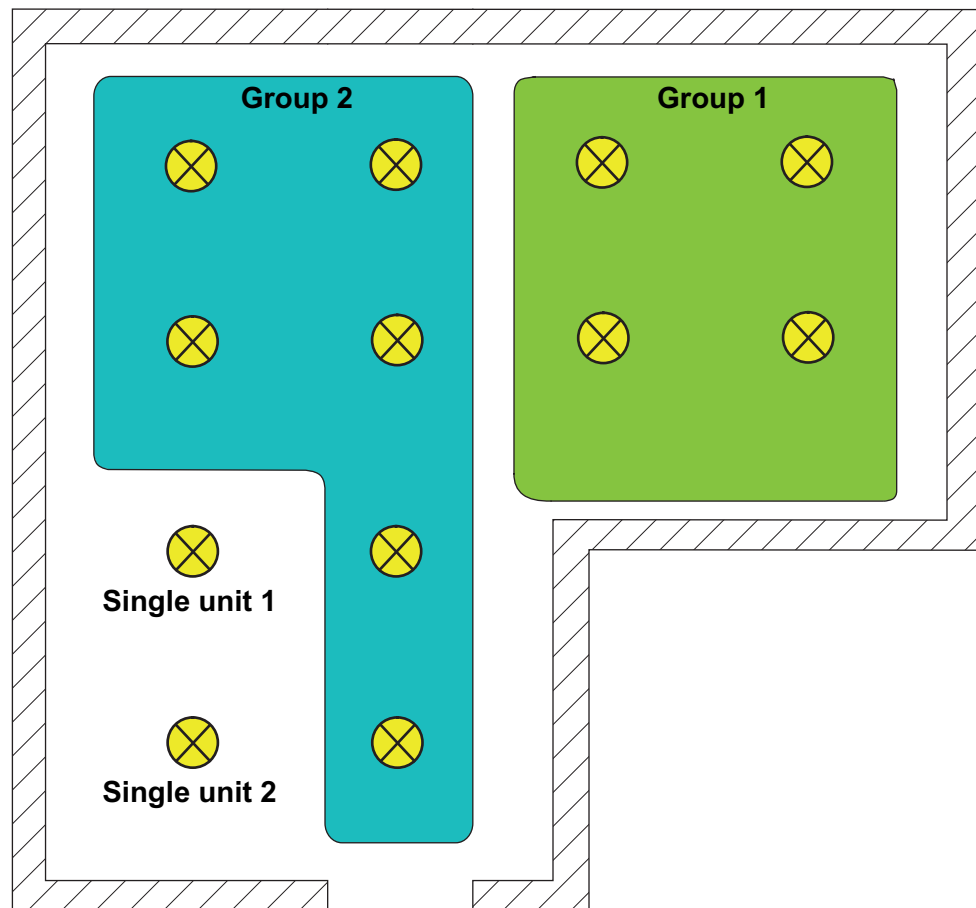

Figure 13: Example of group and single device control

- Group control 1...32 and group control 1...64:
This addressing type behaves in exactly the same way as the "Group control 1...16 and device control 1...64" addressing, with the difference that groups 17...32 are also available. Here too, groups 17...32 can only be assigned to up to two DALI operating devices. In this case too, as there are no DALI group addresses, DALI addressing takes place using the device short addresses, meaning that the operating devices are addressed, and thus contacted, individually.
- Device control 1...64:
This addressing type only allows control of up to 64 single devices. DALI group addressing is not possible. As with the other addressing types with device control, the addressing of the devices takes place individually using the device short addresses. It is advisable to use this addressing type if all operating devices are to be controlled individually, for example, and group control is therefore not appropriate.

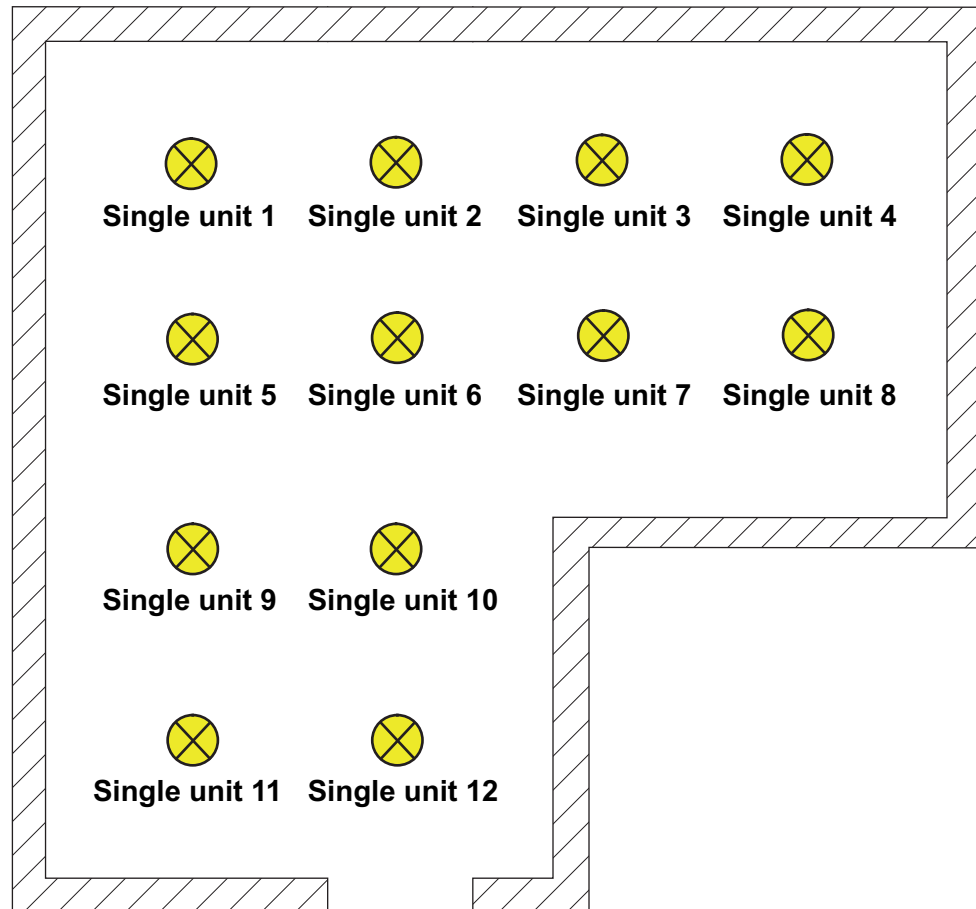

Figure 14: Example of single device control - All the DALI operating devices can be controlled individually

Special case: Multiple assignment of DALI operating devices to different groups

For special cases, it is possible to assign operating devices for group control to more than just one DALI group. In the standard case, assignment of a DALI operating device is only possible in one device. This makes device assignment clear, and the unique assignment means that there are no group overlaps and, as a result, no influencing of configuration and feedback values. If necessary, multiple group assignment can be enabled as an alternative. For this, the checkbox "Hide previously assigned DALI devices" must be deselected in the Commissioning dialog of the plug-in (by default, this checkbox is set). This means that it is then possible to assign DALI operating devices to more than just one group during online commissioning.

- i** Multiple assignment of operating devices as part of offline commissioning (creation of new single devices in the tree structure of a group) is not possible. When editing the short address in the parameter node of a group-related electronic ballast, no addresses can be entered that have already been entered for electronic ballasts of other groups.
- i** Multiple assignment of DALI operating devices to different single devices of the project design (device control) is not possible.

DALI operating devices can always be assigned to any group. However, we do not recommend assigning the operating devices to multiple groups on the DALI side. It is better to split the devices up into separate, non-overlapping groups and to create a KNX-side link using the group addressing in the ETS.

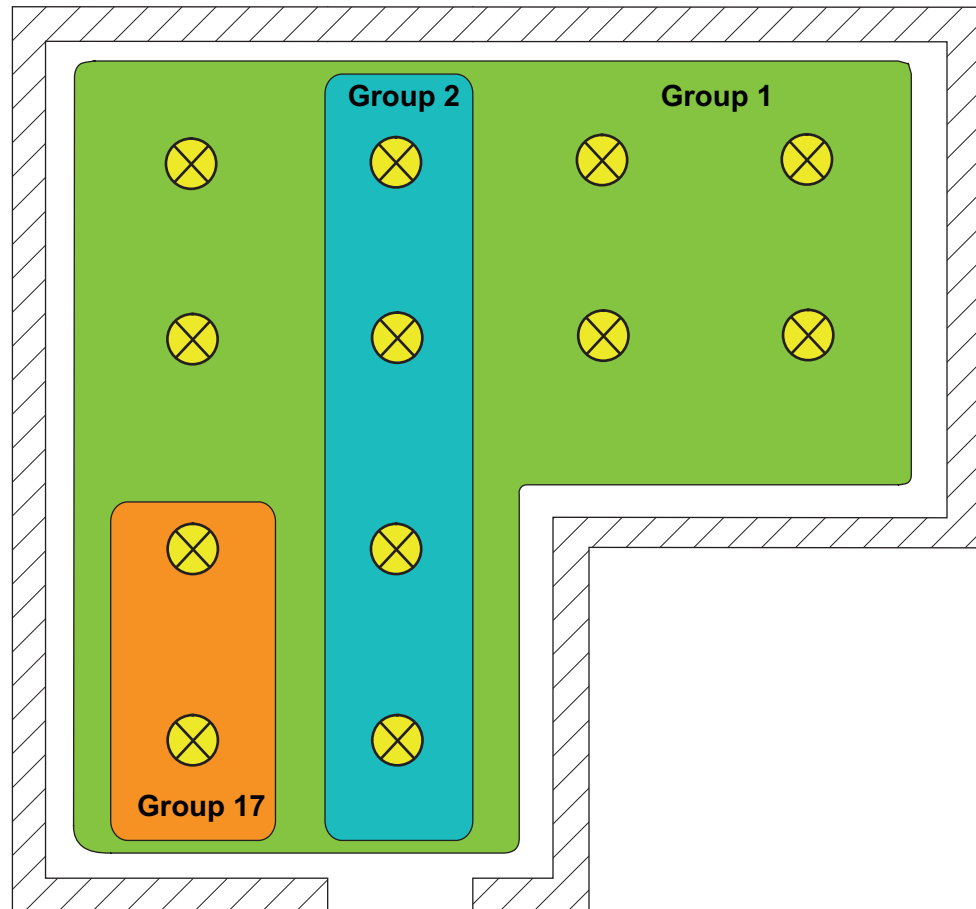

Figure 15: Example of multiple assignment of operating devices -
Here: Group 1 overlaps with Group 2 and Group 17

- i** DALI operating devices assigned to multiple groups always set themselves to the most recent status set using one of the assigned groups. In this case, feedback of the switching status, brightness value or colour temperature of a group cannot always be clear. The following examples explain this behaviour (figure 15):

Example 1: Group 1 is set to 10 % brightness. After this, Group 2 is dimmed to 20 % brightness. The lights of Group 2 assume the most recently recalled brightness value: 20 %. The feedback of Group 1 remains at 10 %, although some of the operating devices belonging to the group were set to 20 % brightness.

Example 2: Group 1 is switched on and sets itself to the brightness value 100 %. The status of Group 2 internally in the DALI Gateway remains at 0 % brightness (OFF). Now Group 2 is made brighter. The lights of Group 2 adopt the dimming behaviour (becoming brighter from minimum brightness), although these lights have already been switched on by Group 1.
- i** If DALI operating devices are assigned to multiple groups and these groups were assigned to a shared scene, then all operating devices will adjust to the brightness value or colour temperature value specified by the group with the highest number.

Example: An electronic ballast was assigned to Groups 1 and 2. Both groups are assigned to Scene 1. When the scene is recalled, Group 1 is to set itself to 10 % and Group 2 to 20 % brightness. When Scene 1 is recalled, the electronic ballast is set to 20 %, as Group 2 has the higher group number.

DALI device type

Optionally, the assignment of DALI operating devices to programmed groups or single devices can be supplemented by testing of the DALI device types. If testing is enabled, the plug-in compares, during assignment as part of commissioning, the device types determined by the operating devices with the specifications by the device type parameters. Assignment can only take place if there is agreement. This will prevent functional incompatibilities after commissioning.

The function for testing the DALI device types is enabled by the "Use 'DALI device type' setting?" parameter in the "General" parameter node when it is set to "yes".

This ETS plug-in allows testing and assignment of the DALI device types listed in the following table...

Number of DALI device type	Name
0	Ballast for fluorescent lamps
2	Ballast for discharge lamps
3	Ballast for LV halogen lamps
4	Ballast for Incandescent lamps
6	LED module
7	only switchable ballast
8	Control gear for colour control (Tunable White)
255	Multitype

Supported DALI device types for enabled testing

Device types not contained in the above table (e.g. type "1 - emergency light, single-battery-operated" or "9 - Sequencer") are identified by the DALI Gateway, although they cannot be assigned to a group or any single device during DALI commissioning, if device type testing is activated.

i For integration of DALI operating devices according to device type 8 (Tunable White): If operating devices according to device type 8 in the specific version "Tunable White (TW)" are used, the ETS plug-in of the Gateway checks the DALI device type indicated by the installed operating device (electronic ballast found) as part of the device assignment during DALI commissioning. Testing of the DALI device type is then essential and therefore cannot be switched off in the ETS plug-in for integration of tunable white luminaires. This avoids incorrect assignments.

Some DALI operating devices have the device type "Multitype". Such devices can be integrated into the tunable white function provided that these are enabled for this application. The ETS plug-in identifies this by reading out specific properties during DALI commissioning. There are multitypes that are unsuitable for tunable white controls.

4.2.4.1.2 DALI emergency lighting systems

The DALI Gateway can be integrated into DALI emergency lighting systems. It allows interference-free operation of operating devices, general lighting systems and emergency lighting operating devices of the same DALI system. The device is able to integrate standard DALI operating devices for lighting control according to IEC 62386-101 (DALI System) and IEC 62386-102 (Control Gear) into centrally-supplied emergency lighting systems as an emergency light.

i **The statutory and standard specifications vary from country to country. In any event, the user / technical planner should check whether the specific specifications should be maintained.**

No emergency lights with special DALI operating devices are used in an emergency lighting system, supplied by group or central battery systems. Instead, standard devices are used according to the basic DALI standards. These devices, which are primarily intended to control general DALI lighting systems, usually only possess one mains voltage connection and do not possess a battery for self-supply, should the mains voltage fail.

In centrally-supplied emergency lighting systems, a distinction is made as to which parts of the electrical building installation are supplied by the emergency power supply. When KNX and DALI systems are combined, the following three applications result. In each of the cases, if the general power supply fails, a suitable switching unit must ensure that the system switches to the central emergency power supply after detection of the failure, so that the emergency lighting is activated and functioning...

- Emergency operation only comprises DALI lights:
 In this application, either all or only individual DALI operating devices are connected to the emergency power supply (figure 16). The KNX system and DALI Gateway are not supplied with emergency power, which means that if the mains voltage fails, these subsystems will no longer function. If there is a fault, there is no DALI voltage because the power supply of the Gateway is no longer working.
 Due to the switched-off DALI voltage, the operating devices supplied with emergency current set the "System Failure Level" saved in the device at the beginning of emergency operation as the brightness value. This brightness value was written by the DALI Gateway to the DALI operating devices after ETS commissioning. By default, the "System Failure Level" is defined by the "Behaviour in case of bus voltage failure" parameter of a group or single device. Optionally, this value - irrespective of the behaviour in case of bus voltage failure - can be set to a separate brightness value for emergency operation.
 When activating operating devices that support the device type "Colour Control" (DALI Device Type 8), the effective colour temperature in emergency operation does not change in this configuration. The Gateway initialises the DALI operating devices so that the colour temperature remains unchanged if the DALI voltage fails.

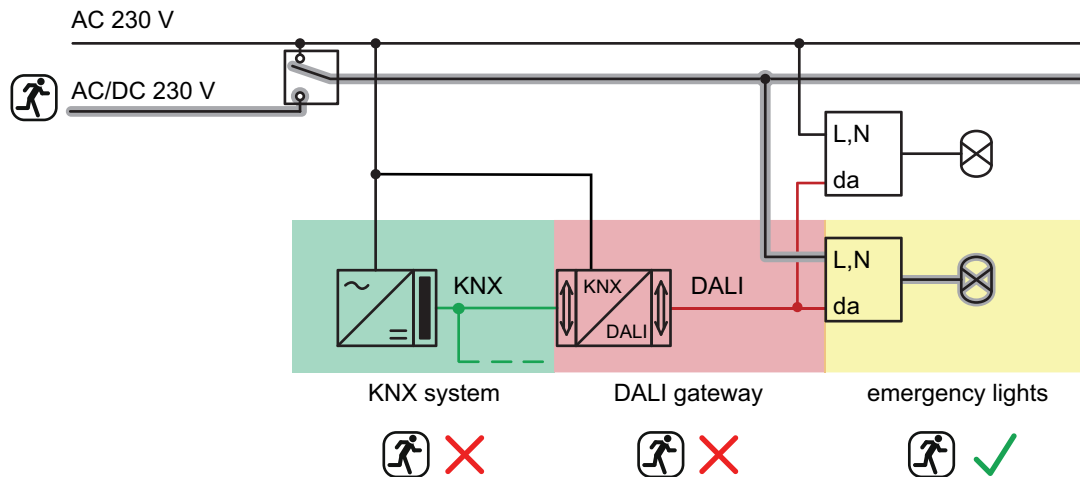

Figure 16: Example of a central supply -
Only DALI operating devices integrated into the emergency power supply

- Emergency operation comprises DALI lights and KNX system:
In this application, all or individual DALI operating devices as well as the power supply of the KNX system are connected to the emergency power supply. The DALI Gateway is not supplied with emergency power, which means that it will no longer function if the mains voltage fails. If there is a fault, there is no DALI voltage because the power supply of the Gateway is no longer working.
Due to the switched-off DALI voltage, the operating devices supplied with emergency current set the "System Failure Level" saved in the device at the beginning of emergency operation as the brightness value. This brightness value was written by the DALI Gateway to the DALI operating devices after ETS commissioning. By default, the "System Failure Level" is defined by the "Behaviour in case of bus voltage failure" parameter of a group or single device. Optionally, this value - irrespective of the behaviour in case of bus voltage failure - can be set to a separate brightness value for emergency operation.
When activating operating devices that support the device type "Colour Control" (DALI Device Type 8), the effective colour temperature in emergency operation does not change even in this configuration. The Gateway initialises the DALI operating devices so that the colour temperature remains unchanged if the DALI voltage fails.
Since the KNX system continues working without interruption if the mains power fails, mains failure messages that the Gateway can produce before switch-off (feedback of supply voltage failure) can be evaluated and processed.

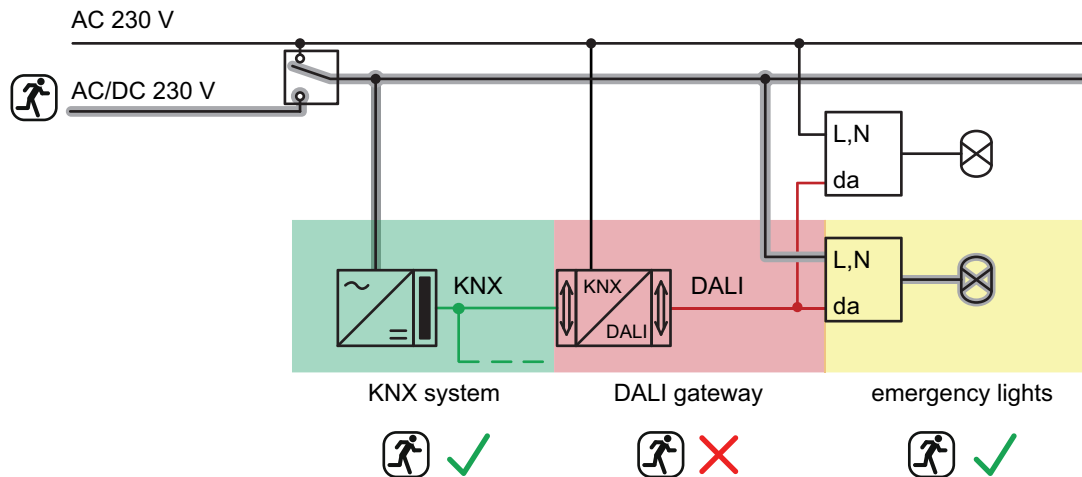

Figure 17: Example of a central supply - DALI operating devices and KNX system integrated into the emergency power supply

- Emergency operation comprises DALI lights, KNX system and DALI Gateway (recommended application):

In this application, all or individual DALI operating devices, the power supply of the KNX system and the mains voltage connection of the DALI Gateway are connected to the emergency power supply (figure 18). If there is a fault, DALI voltage will remain since the power supply of the Gateway continues working.

In this application, the DALI operating devices do not switch automatically to the "System Failure Level". Instead, the Gateway controls selected operating devices at a special brightness value for emergency operation. This brightness can be configured in the ETS plug-in within the limits of minimum and maximum brightness if necessary. Alternatively, it is possible to define no special behaviour at the beginning of emergency operation. In this case, the operating devices assigned to emergency operation remain at the last set brightness value.

When activating operating devices that support the device type "Colour Control" (DALI Device Type 8), a colour temperature can also be defined for the emergency operation besides a brightness value in this configuration.

As, if the mains power fails, the KNX system and the Gateway continue working without interruption, mains failure messages and all status and feedback functions can continue to be used. The Gateway is also able to evaluate all the KNX commands coming in during emergency operation and to save them, so that they can be tracked at the end of emergency operation.

In this application, emergency operation is activated by the Gateway. It instigates all the appropriate actions on the KNX and the DALI page. Identification of a mains failure as the cause of emergency operation can take place in different ways. Either the Gateway automatically identifies whether mains voltage is present or not, using the diagnosis of the DALI operating devices. This is possible through contacting and reading out all commissioned DALI devices. If a number of these devices specified by the programmer do not respond, the Gateway will assume that the mains voltage has failed. In addition, or alternatively, a KNX telegram can inform the Gateway that emergency operation is to be activated. This is useful, for example, when a KNX binary input is monitoring the mains voltage and transmits a message telegram if there is a mains failure.

- i** In this application, the DALI cable may not be disconnected or enabled anywhere (no use of DALI junctions, or similar). DALI communication must be possible without interruptions.
- i** The brightness value for emergency operation, which can be set, if configurable, for each group or each single device in the Gateway, is also entered into the DALI operating devices as the System Failure Level. If the mains voltage supply of the DALI Gateway should fail, and consequently the DALI voltage, the operating devices affected will also set themselves to this brightness value.

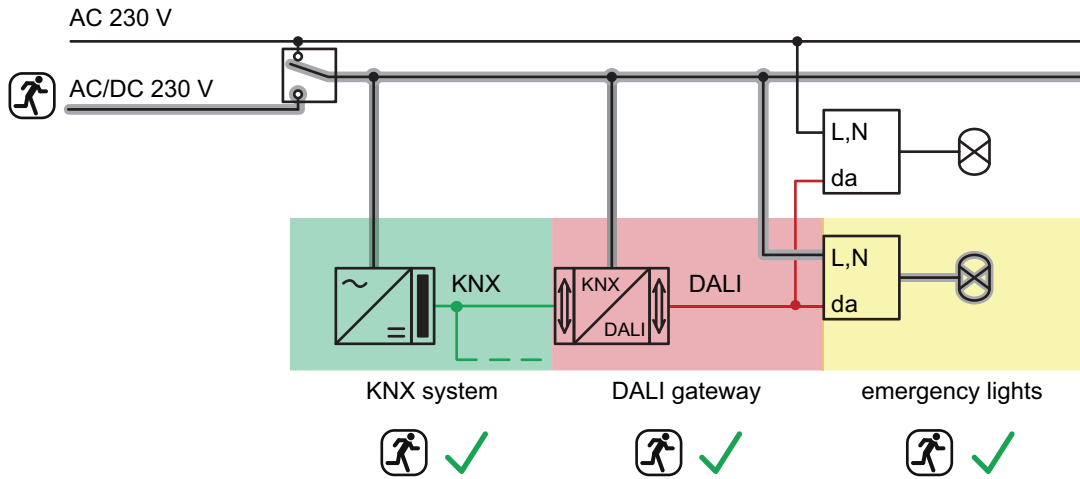

Figure 18: Example of a central supply - DALI operating devices, KNX system and DALI Gateway integrated into the emergency power supply

4.2.4.1.3 ETS plug-in

Program window

The setting of all the devices parameter, DALI commissioning and also the DALI test are entirely carried out by a plug-in embedded in the ETS. The plug-in is a component part of the product database and is installed automatically, when the device is inserted into an ETS project from the product catalogue and is accessed. There is no need to install additional software. The plug-in is started by opening the Parameter view of the DALI Gateway. Then the ETS used will see the program window of the plug-in.(figure 19).

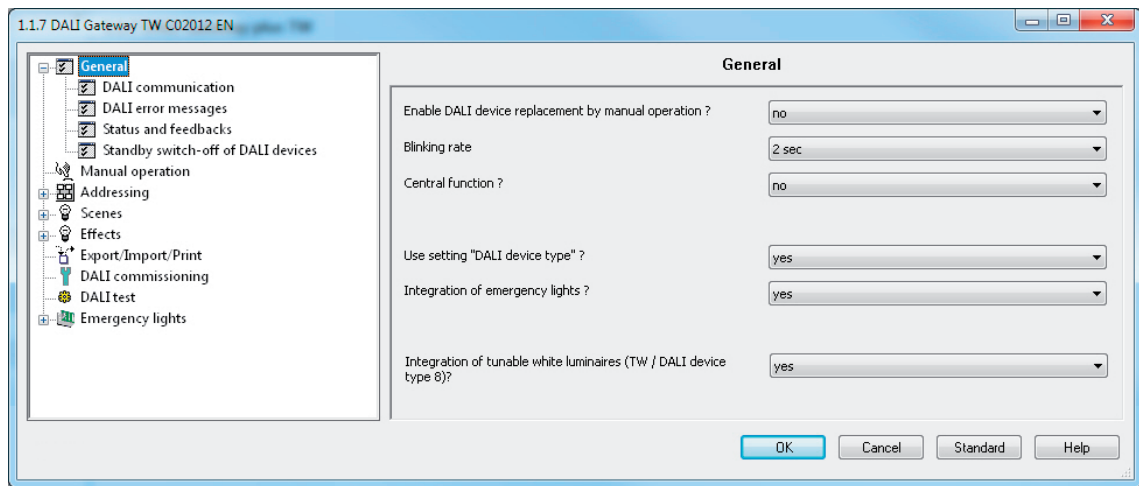

Figure 19: Program window of the ETS plug-in

The program window is primarily divided up into two areas. The left-hand pane contains all the parameter pages of the group-related, device-related and multi-channel parameters in a tree structure. Configuration pages for commissioning, the import/export function and the DALI test are also available in this window. The individual pages can be selected and opened by clicking the mouse or navigating with the keyboard. The parameters and operating elements assigned to the parameter page then become visible in the right-hand pane.

There are 4 buttons in the lower area of the window. The **OK** button exits the plug-in and saves the set parameters and configurations to the ETS database.

The **Cancel** button exits the plug-in, without saving the data to the ETS database. Any changes to the parameter settings are lost. In addition, previously set DALI commissioning parameters are not applied to the ETS database. However, previously performed DALI commissioning remains in the DALI operating devices. This can lead to cancellation operations or data incompatibility. An information message warns the ETS user, preventing mistaken program cancellations.

When pressed, the **Standard** button resets all the parameters of the DALI Gateway to the standard values supplied by the manufacturer in the product database. Any changes to the parameter settings deviating from the standard specifications are lost. Any created groups and devices will be deleted. The parameters of the DALI commissioning ("Hide previously assigned DALI devices", "Compatibility mode for DALI commissioning" and "Partial DALI commissioning") are not reset to the standard configuration". These parameters always remain at the states last set. Assignments of DALI operating devices to groups or single devices are lost. However, previously performed DALI commissioning remains in the DALI operating devices. For this reason, when resetting to standard parameters, also perform a reset of the connected DALI subscribers or commissioning with a new group assignment.

When pressed, the **Help** button opens this product documentation of the DALI Gateway as online help.

Creating DALI groups or single devices

Depending on the addressing type configuration, up to 32 DALI groups are available for group addressing. For alternative control, these can be supplemented with 64 individually-addressable DALI device channels, as necessary. DALI groups and single devices are created in the plug-in and configured separately. At least one group or single device has always been created.

Additional groups or devices can be added to the configuration by selecting the appropriate parameter node in the tree view and then executing the command **New** using the context menu (right mouse-click).(figure 20).

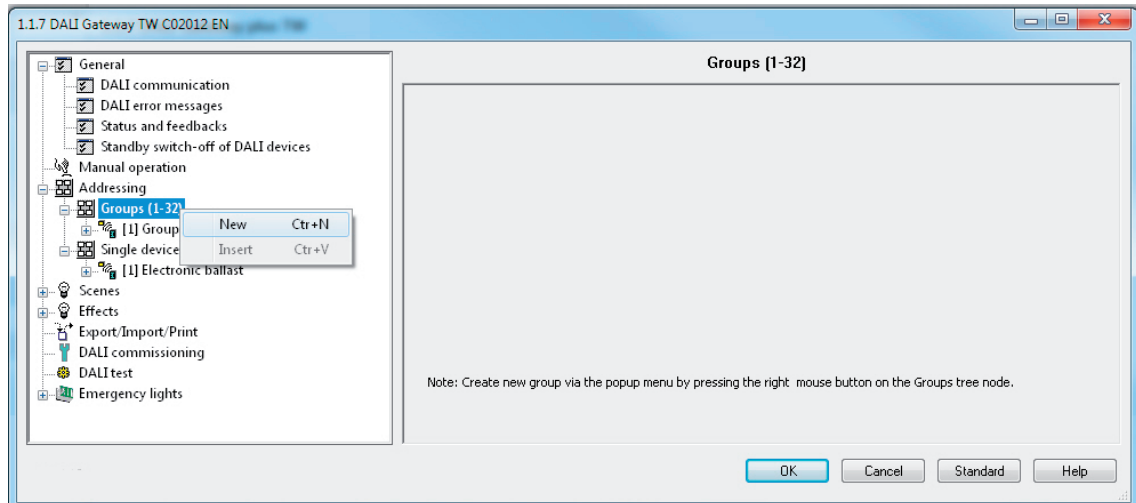

Figure 20: Additional DALI groups (single devices can be added in the same manner)

Created groups or single devices can also be copied using the **Copy** command of the context menu of a group or device node and inserted into the higher-level node as a new group or new single device using **Insert**. Parameter settings are also applied. It is also possible to insert a previously copied group into an existing group. In so doing, all the parameter settings of the existing group, although not assigned single devices, are transferred from the copied group. This allows the creation of groups with an identical configuration (e.g. in large DALI systems) quickly and without much work. Copying and insertion into existing nodes can be performed in the same way for single devices.

- i** It is possible to copy a group and insert it into the parameter node of a single device. For this, the configuration of the group is applied to the single device. It is also possible to copy single devices and insert them onto group nodes. Only the parameters supported by the target node are copied.

Created groups or single devices can be deleted at any time by selecting the appropriate parameter node in the tree structure and executing the **Delete** command of the context menu. Note that at least one group and / or single device must always have been created. In addition, a parameter can be used to assign a name to each group and each single device. It is possible to change a name at a later date using the parameter configuration or, alternatively, by using the **Rename** command in the context menu. We recommend labelling each group and each single device clearly by giving it a name (e.g. "Light strip window, south", "Sports, office, central", etc.). The name may be a maximum of 28 characters and may contain alphanumeric and special characters.

Each DALI group receives a unique group number (1...32), which is shown in square brackets before the group name. In the case of single devices, the DALI short address (1...64) is displayed in square brackets. The DALI short addresses are always assigned in the parameter configuration of the single devices and can thus be influenced. Consecutive group numbers are generated by the plug-in itself when new groups are created (next free address).

With the addition of group and device names, unique naming of DALI operating devices is possible by referencing the numbers and short addresses. Through the transmission of the unique names to the KNX building visualisation (e.g. control panels), the user is able - particularly during error diagnosis - to identify the lighting components easily. The group and

device numbers are also displayed in the 7-segment display on the front of the device during active operation .

- i Each group and each single device can be configured independently in the plug-in. After configuration during DALI commissioning, the individual DALI operating devices are programmed with the configured short addresses. The configuration of the groups and single devices is transmitted to the DALI operating devices when the Gateway is started after an ETS programming operation. In so doing, all the operating devices assigned to a DALI group are configured identically. If DALI operating devices are assigned to multiple groups, these devices will then receive the project design of the group with the highest group number.

Creating scenes, effects and effect steps

Lights or light groups can optionally be integrated in up to 16 scenes, meaning that preprogrammed static light scenes can be recalled. In particular, for the implementation of dynamic light scenes, it is possible to include lights or light groups in the effect control of the DALI Gateway. Up to 16 effects are available here, each with up to 16 effect steps. Each effect step represents an individual light scene.

Scenes and effects are created in the ETS plug-in and are configured separately. A scene or an effect can be added to the configuration by selecting the appropriate parameter node in the tree view and then by executing the command **New** using the context menu (right mouse-click).(figure 21).

Up to 15 effect steps can be created for each effect, as necessary. The sixteenth last step of an effect is always the stop step in the configuration. This is only executed when the effect is stopped automatically after the number of run-throughs has been reached or the user performs the Stop command. This makes it possible to set a defined lighting state.

A new effect step can be added by selecting an effect parameter node in the tree view and then executing the **New** command in the context menu. This always adds the first step of an effect. If steps already exist, these are always shifted one place when new steps are added. The existing steps are thus given a new, higher step number (2...15 / 16 = Stop step).

- i When new effects are created, all the necessary effect steps should always be created directly, in order to avoid subsequent editing and shifting of the effect sequences due to the adding of new steps.

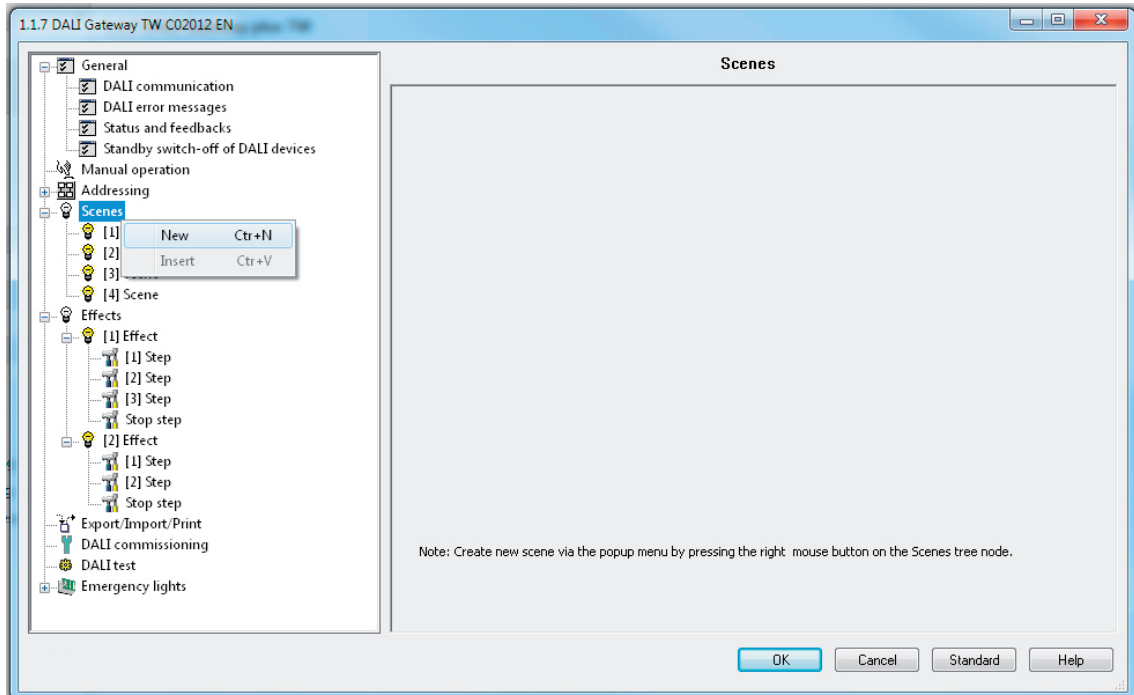

Figure 21: Adding scenes (effects and effect steps can be added in the same way)

Created scenes and effects can also be copied using the **Copy** command of the context menu of an appropriate scene or effect parameter node and inserted into the higher-level nodes "Scenes" or "Effects" as a new scene or new effect using **Insert**. Parameter settings are also applied. It is also possible to insert a previously copied scene or effect into an existing scene or effect. All the parameter settings are applied without creating a new element. Effect steps can only be copied and inserted into existing steps. This completely transfers the configuration of the copied step into another step. This function can be used, for example, to transport existing step configurations into other steps, after new steps have been added, thereby changing the sequence of the light scene.

Created scenes, effects and effect steps can be deleted at any time by selecting the appropriate parameter node in the tree structure and executing the **Delete** command of the context menu. In addition, a parameter can be used to assign a name to each scene or effect. It is possible to change a name at a later date using the parameter configuration or, alternatively, by using the **Rename** command in the context menu. We recommend labelling each scene or effect clearly by giving it a name (e.g. "Scene TV", "Effect window", etc.). The name may be a maximum of 28 characters and may contain alphanumeric and special characters.

Each scene and effect receives a unique number (1...16), which is shown in square brackets before the name. This number is only a label within the ETS plug-in for distinguishing clearly between the individual scenes and effects, even if they have the same name. In addition, scenes and effects have KNX numbers (1...64). These KNX numbers can be used to recall a scene or a scene memory function and to start and stop the effects using the extension objects of these functions. Scene and effect numbers do not have to be identical to KNX extension numbers. The KNX numbers are configured individually.

KNX numbers must be unique. It is not possible to assign the same KNX numbers to multiple scenes. The same applies to the KNX numbers of the effects.

In the case of effect steps, the step number (1...15 / 16 = Stop step) is displayed in square brackets. This labels the step sequence of an effect run-through directly.

Import and export of templates or backup files

Complete device planning (all parameter settings, KNX group addresses and object configuration) as well as all DALI commissioning parameters (found DALI operating devices,

long and short addresses and group/single device assignments) can be exported to an external XML file and thus backed up. In addition, an import of previously backed-up data is possible at any time. This makes simple data backup possible, even outside the ETS database. In addition, existing device planning can be downloaded as a template even to other DALI Gateways of the same type, thus simplifying the configuration of a new device considerably.

The import and export function can be executed on the parameter page **Import / Export / Print** of the plug-in.

Pressing the **Export** button exports the complete current device configuration of the plug-in to an XML file. Before exporting, it is possible to specify the memory location of the file. The plug-in displays the progress of the export operation. The operation may take some time. The length of time depends on the number of existing groups and single devices, the created scenes and effects as well as on the DALI operating devices available.

- i The data is exported in "*.XML" format. Microsoft XML-Parser 3.0 or higher must be installed on the PC ("msxml3.dll") in order to export an XML file. An appropriate installation can be downloaded from the Microsoft website ([www.microsoft.com/downloads / search](http://www.microsoft.com/downloads/search) term: "msxml"). "MSXML 3.0 Service Pack 4" or a later version is required as the appropriate program package.
If the program package is not installed, the plug-in of the DALI Gateway will display an error message when the Export command is executed.

Pressing the **Import** button can download a previously exported XML file to the device configuration. It should be noted that, during an import operation, the current configuration of the plug-in in the ETS, including all the commissioning parameters of the DALI operating devices, is always overwritten. For this reason, the plug-in issues a warning of this characteristic before the process is executed.(figure 22).

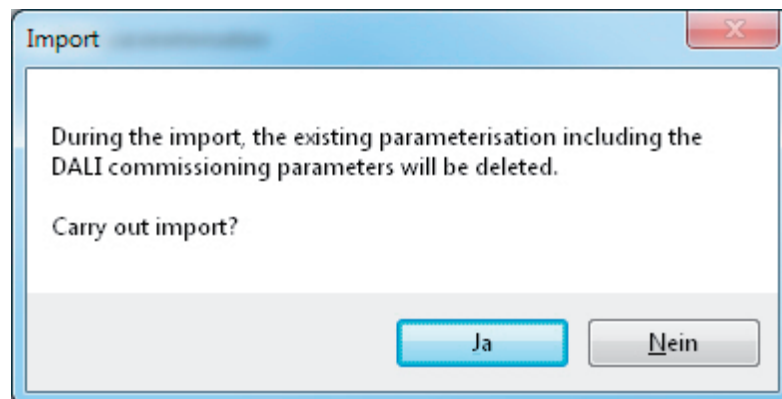

Figure 22: Note before an import operation

After confirmation of the import, the plug-in asks whether the import should take place with or without KNX group addresses.(figure 23). In the case of an import without group addresses, the plug-in does not apply any associations between the communication objects and the group addresses of the XML file. After the import operation, no group addresses are connected to objects. Alternatively, an XML import can also be carried out with the application of the KNX group addresses saved in the XML file. Before application, the plug-in tests all the group addresses of the XML file. If there are no group addresses in the ETS project, they will be created in the project. If object types do not match (e.g. group address 1/1/1 is linked to 1-bit objects in the ETS project and with a 1-byte object in the XML file), the addresses concerned will not be imported from the XML file. The plug-in then displays an information window and lists the group addresses with a data type conflict. These conflicts must then be resolved manually by the ETS user if all group addresses are actually applied.

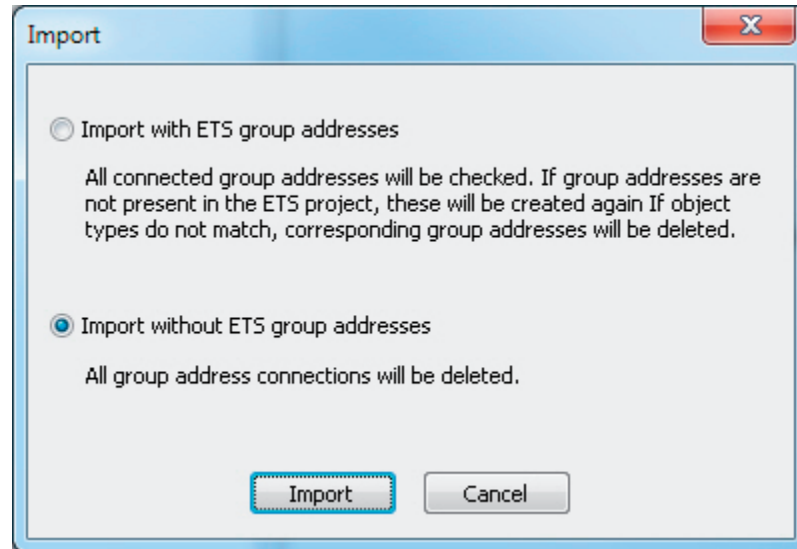

Figure 23: Import dialog to select an import with or without KNX group addresses

- i** After the import of an XML file, an ETS programming operation of the application program must take place so that the configuration data are applied to the Gateway.
- i** An import operation overwrites all the DALI commissioning parameters (found DALI operating devices, long and short addresses and group/single device assignments) with the data of the XML file. It should be noted that only the data saved in the ETS database will be compared. Any previously performed DALI commissioning with programming of the DALI operating device will remain unchanged in the operating devices. For this reason, after the import of an XML template, new DALI commissioning must always take place, too, if DALI commissioning parameters are specified by the XML template other than those most recently programmed into the DALI system online. New DALI commissioning is not necessary if the XML import does not change the commissioning parameters (e.g. during the import of an XML backup file of a previously fully-commissioned system when a DALI Gateway is replaced).
- i** **Important note for the import of XML files with the ETS3 or the ETS4 of up to Version 4.1.6:**
After the import, the affected device must be unloaded using the ETS. Only then should an ETS programming operation be performed. Unloading forces the ETS to perform a complete download. Only in this way is it guaranteed that all the relevant configuration and commissioning data from the import are programmed completely into the device.
On ETS4 from Version 4.1.7, the programming of all the relevant data is automatic and time-optimised. There is no need for the unloading operation here.

It is possible to import the XML file of older versions of DALI Gateways (Jung "DALI Gateway" article number 2097 RMD HE or Jung "DALI Gateway Plus" article number 2098 RMD HE), in order to transfer old configurations to new devices.

When importing old templates from the DALI Gateway (2097 RMD HE) taking the function properties of these devices into account, the following characteristics and restrictions apply...

- Only groups are imported (the addressing type "Group control 1...32" is set).

- Functions that are not available in the old DALI Gateway (e.g. operating hours counter, DALI telegram rate limit, collective feedback, effects) are deactivated after the import. These functions can then be enabled and configured as necessary.
- Communication flags and data point types of objects and transmission flags of group addresses are not transferred. Manual adjustments may have to be performed here after the XML import if necessary.

When importing templates from the DALI Gateway Plus (2098 RMD HE), the following characteristics and restrictions apply...

- No single-battery-operated DALI emergency lights can be imported. When importing a template that contains single-battery-operated emergency lights (no centrally supplied emergency lights available), the plug-in displays an information message, deactivates the emergency lighting function completely and sets the devices concerned to "Ballast for fluorescent lamps". When importing a template with centrally supplied and single-battery-operated emergency lights, the plug-in retains the emergency lighting function, configures the parameter "emergency light system" to "centrally supplied" and sets the single-battery-operated devices concerned to "Ballast for fluorescent lamps". The XML import applies all settings unchanged for centrally supplied emergency lights.
- Functions that are not available in the old DALI Gateway Plus (e.g. colour temperature control) are deactivated after the import. These functions can then be enabled and configured as necessary.

i It is not possible to import XML files, exported using the plug-in of the devices described in this documentation, into the configurations of older devices.

Print function

The plug-in of the DALI Gateway also offers the option of printing out the complete device configuration incl. the group/single device programming, the scene and effect configuration and all the DALI commissioning parameters as a configuration report. The Print function can be executed on the parameter page **Import / Export / Print** of the plug-in. When the **Print** button is pressed, the plug-in asks whether the complete device configuration should be printed out on paper or only a part of the DALI commissioning parameters, incl. the DALI device names and short addresses (figure 24).

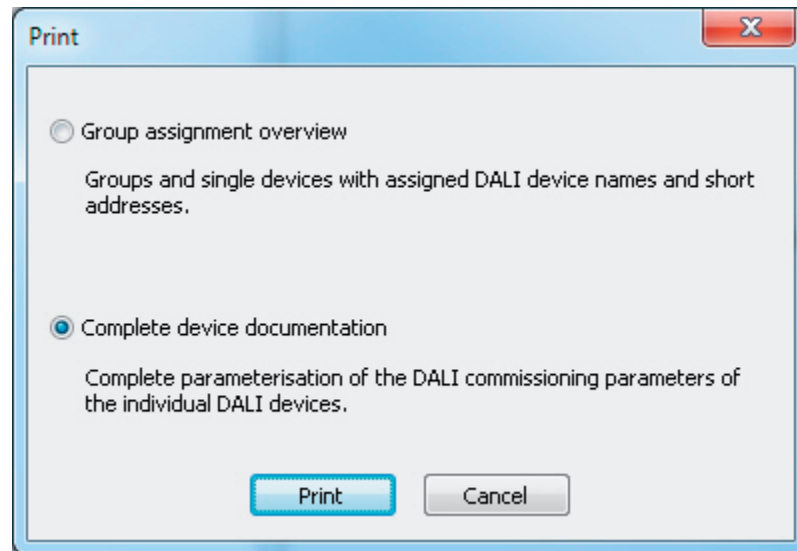

Figure 24: Print dialog to select the printing options

4.2.4.2 Description of group- and device-independent functions

4.2.4.2.1 DALI communication

The DALI telegram rate limit can optionally be activated. Firstly, it is then possible to extend the period of time between DALI telegrams. Secondly, the initialisation behaviour of the Gateway can be influenced. By using the DALI telegram rate limit, it is possible to adapt the communication behaviour of the Gateway to problematic or non-DALI-conformant operating devices to a great extent.

The DALI telegram rate limit is activated and configured in the parameter node "General -> DALI communication".

Time delay between two DALI telegrams

In accordance with the valid DALI standard (IEC 82386-101/102 Ed. 1), pauses of at least 9.15 ms must be maintained between the transmissions of individual DALI telegrams to the operating devices. To optionally reduce the telegram load for the DALI operating devices and thus reduce the likelihood of errors on the part of some electronic ballasts, it is possible to increase the pause time between telegrams of the DALI Gateway to the operation device by a multiple of the minimum pause time (figure 25). This produces a telegram rate limit, which can be adjusted individually using the parameter "Minimum delay time between two DALI telegrams" in the parameter node "General -> DALI communication" in the range 1...5 in steps of 0.5. For this parameter to be visible, the DALI telegram rate limit must be active on the same parameter page.

Extending the pause time between the telegrams gives the operating devices more time to react to the commands of the DALI Gateway. However, this also delays the reaction time of the overall DALI system when controlled by KNX telegrams and also during DALI commissioning or a DALI test. As a result, large time factors should be avoided in the delay time parameter, unless explicitly required.

- i** The approved pause time between telegrams from the DALI Gateway to the DALI operating devices and the matching response is within a range of 2.91 ms and 9.15 ms. This time period is required by the operating devices and cannot be influenced to any great extent by the Gateway.

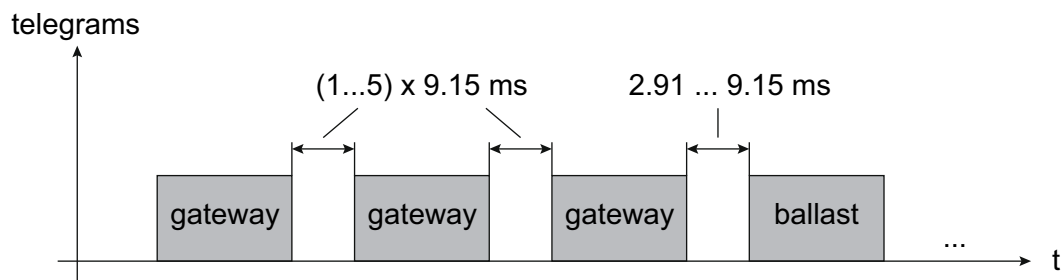

Figure 25: Pause times between DALI telegrams

Delay time after mains voltage return to DALI

After the mains voltage supply is switched on, depending on their type, DALI operating devices usually require different lengths of time to initialise themselves and thus to react to commands of the DALI Gateway. To ensure that no commands of the Gateway to the operating devices are lost after mains voltage return - because they are still initialising - it is possible to activate a delay as an option. This delay is defined within a range of 0...30 seconds using the parameter "Delay time after mains voltage return to DALI", which is available in the parameter

node "General -> DALI communication" when a DALI telegram rate limit is activated. The delay time after mains voltage return delays the start of the application of the DALI Gateway after the mains voltage supply is switched on as well as after an ETS programming operation and thus delays the execution of the configured behaviour after bus voltage return and all other automatic reactions (e.g. feedback messages) after a device reset. No DALI telegrams are transmitted by the Gateway in this state. "-" is displayed on the 7-segment display on the front panel of the device in order to signal that the device is not yet ready for operation.

KNX communication is also possible during the delay time. This allows control of groups and single devices as well as of scenes and effects and the specification of commands. However, these are only executed once the delay time on the DALI page has elapsed. Only the last command relative to a group, a single device, a scene or an effect is ever executed!

- i** If KNX telegrams for groups or single devices are received during Gateway initialisation, the device will perform the most recently specified command and not the configured behaviour after bus voltage return.
- i** The delay time after mains voltage return to DALI is not required if the initialisation time of the DALI operating devices is shorter than that of the DALI Gateway. In this case, the parameter should be set to the value "0". If the operating devices initialise more quickly than the Gateway, they will activate the programmed "Power-On Level" before the Gateway transmits other brightness commands. After mains voltage return, this allows the observation of short-time changes to the brightness states in the DALI system.
- i** Should only the mains voltage supply of the Gateway fail, the operating devices will set themselves to the "System Failure Level". After return of the mains voltage supply, the DALI Gateway - once the delay has elapsed - then transmits commands to the DALI page in accordance with the configured behaviour ("Behaviour after bus voltage return") or the last KNX specification.

4.2.4.2.2 DALI error messages

The DALI Gateway allows feedback of various error states. This means that the general feedback of an existing error in the DALI system, the feedback of the error status of individual operating devices and messages on the state of the supply voltage and a short-circuit on the DALI cable can be configured independently of one another using a KNX telegram.

Feedback of error status in DALI system

The DALI Gateway allows the feedback of the error status of DALI operating devices. (see page 63-64). If individual evaluation and display of the error status of individual electronic ballasts or DALI groups is not required or is to be supplemented with a feedback function, independent of the electronic ballast, it is possible to use the general feedback of the "Error status in the DALI system". This feedback has a separate 1-bit communication object, which allows the signalling of a general error in the DALI installation. The DALI Gateway sets the object value to "ON" as soon as it detects an error in a previously commissioned DALI operating device. Here, it is irrelevant which error was identified by the Gateway (lamp error, electronic ballast error, converter error). The Gateway only resets the object value to "OFF" when all the previously identified errors were eliminated.

To use this feedback function, the parameter "Feedback 'Error status in the DALI system' ?" in the "General -> DALI error messages" parameter node must be configured to the setting "Yes...". The parameter "Type of feedback" determines whether the feedback is an active transmitter or is passive (general error status must be polled).

Setting feedback of the error status in DALI system

The feedback of the general error status can be used as an active message object or as a passive status object. As an active message object, the feedback information is transmitted to the bus whenever the status changes. In the function as a passive status object, there is no automatic telegram transmission. In this case, the object value must be read out. The ETS automatically sets the object communication flags required for proper functioning.

The parameter "Type of feedback" in the parameter node "General -> DALI error messages" defines the function of the feedback object "Error status in the DALI system".

- Set the parameter to "Active signalling object".
The general error status is transmitted as soon as the state changes.
- i** A general error saved in the DALI Gateway is lost when the mains voltage fails. For this reason, after all the errors have been eliminated by switching the mains voltage off on the DALI Gateway and switching it back on again, no feedback is transmitted.
- i** The DALI Gateway initialises after switching on the mains power supply or after an ETS programming operation. If a DALI error is detected in this state, the Gateway will immediately transmit an appropriate feedback telegram. The only time feedback is not sent to the bus automatically is after bus voltage return (mains voltage switched-on permanently on the DALI Gateway during bus failure).
- Set the parameter to "Passive status object".
The general error status will be transmitted in response only if the feedback object is read out by the bus.

Optionally, the general error status can be transmitted repeatedly, if, after a previously identified DALI error, further errors are detected on the same or other operating devices. The parameter "Telegram repetition on new error in DALI system ?" in the parameter node "General -> DALI error messages" specifies the behaviour of the general error status feedback for new errors.

- Set the parameter to "yes".
The general error status is transmitted as "1 - ON" for each new error.

- Set the parameter to "no".
The general error status is transmitted repeatedly for new errors. Telegrams are only transmitted again via the object "Error status in the DALI system", when no more errors are present.

Feedback Error status per DALI operating device

The DALI Gateway allows the feedback of the individual error status of DALI operating devices in up to two different data formats. To use this feedback function, the parameter "Feedback 'Error status per DALI operating device' ?" in the "General -> DALI error messages" parameter node must be set to the setting "Yes...". assigned automatically. Here, it is possible to define whether the feedback is an active transmitter or is passive (error status must be polled). The parameter "Feedback data format" determines whether only a 1-byte object (according to KNX DPT 238.600), a 2-byte object (according to KNX DPT 237.600) or a combination of both objects is used.

The status information "Lamp error" or "Error in operating device (e.g. electronic ballast error)" is transmitted to the Gateway by the DALI components if there is an error, and is saved there. The DALI Gateway makes all the status information about the KNX-side error status objects available. The object values are evaluated in bit-orientated fashion according to the selected data format. A feedback telegram always transmits the status information of only one DALI operating device.

As the master in the DALI system, the DALI Gateway - as soon as it is ready for operation - polls the status of the commissioned electronic ballasts (slaves) cyclically every second. A system with a maximum of 64 DALI devices can identify an error after 63 seconds at the latest. Once an error has occurred in the operating device, it must be eliminated (switch off the mains voltage to the appropriate DALI subscriber and observe the manufacturer's information!). The DALI Gateway detects an eliminated error automatically after commissioning of the repaired device and resets the error state in the feedback.

1-byte error status

Bits 0...5 of the 1-byte error status telegram use the electronic ballast number to indicate to which device the signalled error relates. The electronic ballast numbers of the error status are derived directly from the short addresses of the DALI subscribers. An electronic ballast number (0...63) corresponds to a short address (1...64) minus "1" (example: Short address = "1" -> Electronic ballast number in the error status telegram = "0").

- i** When an error status is displayed, it is irrelevant whether the electronic ballast was assigned to a single device or a group during project design.

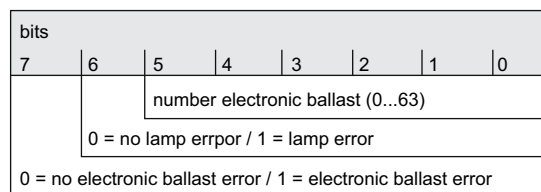

Figure 26: Telegram structure, 1-byte error status

Bit 6 is set when the appropriate electronic ballast signals a lamp error (e.g. defective light, cable break to lamp socket). In an error-free lamp state, this bit is deleted ("0").
 Bit 7 is set when the electronic ballast signals a general error (e.g. internal electronic ballast error). In an error-free device state, this bit is deleted ("0").
 Bits 6 and 7 are set when the appropriate device could not be contacted by the DALI Gateway (e.g. device disconnected from the DALI cable, mains voltage on the electronic ballast switched off).

2-byte error status

In this data format too, Bits 0...5 use the electronic ballast number to indicate to which device the signalled error relates. The electronic ballast numbers of the error status are derived directly from the short addresses of the DALI subscribers. An electronic ballast number (0...63) corresponds to a short address (1...64) minus "1" (example: Short address = "1" -> Electronic ballast number in the error status telegram = "0").

Alternatively, the 2-byte error status can be used to display the collective error state of all the operating devices of a DALI group. For this, the error bits of the individual electronic ballast are collected and evaluated by the Gateway. If any error bit is set in at least one electronic ballast of the group, then the same error bit will also be set in the feedback telegram.

To make it possible to distinguish whether the feedback is addressing an electronic ballast or a group, the error status telegram contains Bit 6. This bit indicates whether a single device ("0") or a group ("1") is addressed. When a group is addressed, Bits 0...5 must contain the group number. A group number (0...15) corresponds to a DALI group number (1...16) minus "1" (example: DALI group number = "1" -> Group number in the error status telegram = "0").

Bit 7 in the telegram indicates whether this is a request telegram ("1") with passive transmission, or, alternatively, an actively-transmitting telegram, or an answer to a request telegram ("0").

- i** When the error status of an electronic ballast is displayed, it is irrelevant whether the operating device was assigned to a single device or a group in the project design. In the case of active telegram transmission, if an error has been identified, only the error status for an individual electronic ballast is generally transmitted and not for a group, provided that the appropriate electronic ballast is also assigned to a group.

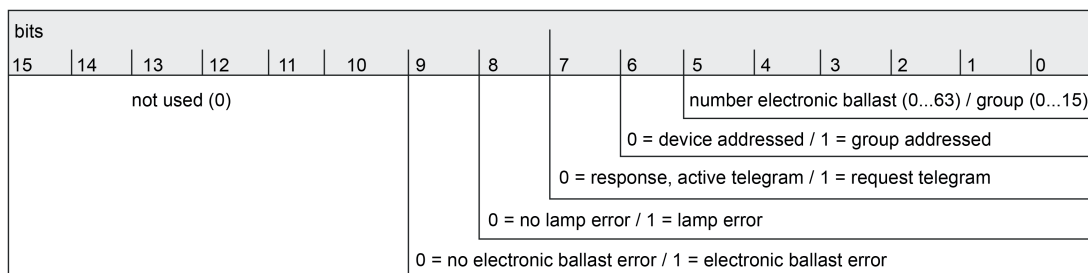

Figure 27: Telegram structure, 2-byte KNX error status

Bit 8 is set when the appropriate electronic ballast or the group signals a lamp error (e.g. defective light, cable break to lamp socket). In an error-free lamp state, this bit is deleted ("0").

Bit 9 is set when the electronic ballast or the group signals a general error (e.g. internal electronic ballast error). In an error-free device state, this bit is deleted ("0").

Bits 8 and 9 are set when the appropriate device or an electronic ballast of a group could not be contacted by the DALI Gateway (e.g. device disconnected from the DALI cable, mains voltage on the electronic ballast switched off).

Setting feedback for error status per DALI operating device

Firstly, it must be specified whether the 1-byte or 2-byte error status is used, or a combination of both objects.

- Set the parameter "Data format of feedback" on the parameter page "General -> DALI error messages" to "Only 2-byte KNX object".

In accordance with KNX DPT 237.600, only the 2-byte object is available. This object can be used both actively and passively (request telegram) and should preferably be used in accordance with KNX specification.

- Set the parameter "Data format of feedback" to "Only 1-byte object".

In accordance with KNX DPT 238.600, only the 1-byte object is available. This object can be used both actively and passively (request telegram).

- Set the parameter "Data format of feedback" to "1-byte and 2-byte KNX object".

The 2-byte object is available in accordance with KNX DPT 237.600, and the 1-byte object is also available in accordance with KNX DPT 238.600. Both objects can be used both actively and passively (request telegram).

In the ETS configuration, it is possible to specify whether the feedback of the error status to the KNX is actively transmitting (telegram transmission on status change) or passive (telegram transmission only as a response to a request telegram).

- Set the parameter "Feedback 'Error status per DALI operating device' ?" on the parameter page "General -> DALI error messages" to "Yes, feedback object is active signalling object". Optionally, the parameter "Time delay for feedback after initialisation" can be used to activate a delay of the 2-byte feedback after Gateway initialisation (ETS programming operation, mains voltage return). The delay time is globally configured in the parameter node "General -> Status and feedback". After initialisation, the 1-byte error status is generally transmitted without a delay.

As soon as an error is detected on a DALI operating device during the cyclical status poll, the DALI Gateway will transmit a feedback telegram with the appropriate electronic ballast/group number to the KNX.

As soon as the error has been eliminated, the DALI Gateway detects the error elimination, provided that the operating power supply to the Gateway was not interrupted, and, accordingly, transmits a feedback telegram "No error" to the KNX.

Should multiple errors have been identified on various electronic ballasts, these will not be retransmitted to the KNX when a device or lamp error is eliminated. The transmission of a feedback telegram related to a DALI operating device or a group will thus only take place once after determination of the error.

- i** In the case of active telegram transmission, if an error has been identified, only the error status for an individual electronic ballast is generally transmitted and not for a group, provided that the appropriate electronic ballast is also assigned to a group.
- i** An error saved in the DALI Gateway is lost when the mains voltage fails. For this reason, after an error has been eliminated by switching the mains voltage off on the DALI Gateway and switching it back on again, no feedback is transmitted.
- i** The DALI Gateway initialises after switching on the mains power supply or after an ETS programming operation. If a DALI error is detected in this state, the Gateway will immediately transmit an appropriate feedback telegram. The only time feedback "DALI error status" is not sent to the bus automatically is after bus voltage return (mains voltage switched-on permanently on the DALI Gateway during bus failure).
- Set the parameter "Feedback 'Error status per DALI operating device' ?" on the parameter page "General -> DALI error messages" to "Yes, feedback object is a passive status object".

There is no automatic telegram transmission to the KNX when an error is detected. To determine the error status of a DALI operating device or a group, the communication object "Error status for each DALI operating device" or "KNX error status for each DALI operating device" must be described externally with a request telegram (ValueWrite). Here, a distinction is made as to whether the 1-byte or the 2-byte error status is used...

1-byte error status: Bits 0...5 of the request telegram must contain the number of the electronic ballast, from which the status is to be polled. Bits 6 and 7 must be set to "1"!

Otherwise, the request telegram is ignored.

2-byte KNX error status: Bit 7 ("1") must be set in the request telegram. Bit 6 must indicate whether a group ("1") or an individual electronic ballast ("0") is being addressed. Bits 0...5 must then contain the number of the electronic ballast or the group number. The states of error bits 8...9 are irrelevant in the request telegram. Bits 10...15 must always be "0"!

Otherwise, the request telegram is ignored.

The DALI Gateway responds to a received, valid request telegram immediately (ValueWrite) by transmitting the current status once as a response.

- Set the parameter "Feedback 'Error status per DALI operating device' ?" on the parameter page "General -> DALI error messages" to "no".

The feedback of the error status per DALI operating device is deactivated. No communication object is available for this function.
- i** Request telegrams to electronic ballast or group numbers, which are not configured in the DALI system and are thus not available, are always answered with deleted error bits. Request telegrams to group numbers greater than 15 (DALI group number greater than 16) are never answered.
- i** A read telegram (ValueRead) to the communication object "Error status per DALI operating device" or "KNX error status per DALI operating device" is answered, if the Read flag is set, by the DALI Gateway transmitting the most recently updated object value (ValueResponse). This means that DALI operating devices cannot be polled clearly.

Feedback for mains voltage supply on the DALI Gateway

The DALI Gateway can monitor its supply voltage at the mains voltage connection. If there is a failure, the Gateway is able to transmit a message telegram to the KNX before stopping operation, provided that the bus voltage is uninterrupted. Optionally, the switch-on of the mains voltage supply can also be fed back.

If the mains voltage supplies of the Gateway and the connected DALI operating devices are connected to the same circuit, the operating state of the entire DALI system which is not supplied with emergency current can be monitored on the KNX through the evaluation of the mains voltage feedback.

The DALI Gateway uses the 1-bit communication object "Voltage failure in the DALI system" to feed back a voltage failure or return. The telegram polarity of this object is fixed: Mains voltage available = 0, Mains voltage failure = 1.

Setting feedback for mains voltage supply

In the ETS configuration, it is possible to specify whether only a failure of the mains voltage supply of the DALI Gateway is fed back to the KNX or whether mains voltage return is also fed back. Telegram transmission is always actively transmitting. As soon as there is a change of state in the mains voltage, a feedback telegram is transmitted once. The parameter "Feedback, DALI Gateway supply voltage failure/return ?" in the "General -> DALI error messages" parameter node defines the behaviour of mains voltage monitoring.

- Set the parameter to "Yes (only on voltage failure)".

If a mains voltage failure is detected on the DALI Gateway, the Gateway will immediately transmit a feedback telegram. It stops operation just a few seconds later.
- Set the parameter to "Yes (on voltage failure and return)".

If a mains voltage failure is detected on the DALI Gateway, the Gateway will immediately transmit a feedback telegram. It stops operation just a few seconds later. The DALI Gateway initialises when the mains power supply is switched on. Then it transmits one feedback telegram and signals that the mains voltage is switched on.
- Set the parameter to "no".

The feedback of the state of the mains voltage supply is deactivated. The communication object is hidden.
- i** The feedback of a mains voltage failure can only be transmitted when the bus voltage is connected and switched on at the time of the failure. If, at the time of mains return, no bus voltage is connected or switched on, no feedback for mains voltage return will be transmitted either. The feedback is saved, however, which means that it is transmitted later when the bus voltage is switched on.

- i** The feedback telegram can be transmitted to the bus automatically after bus voltage return or after programming with the ETS if there is mains voltage on the DALI Gateway.

Feedback for DALI short-circuit

The DALI Gateway detects short-circuits on the DALI cable, as may occur in the case of an installation error. As soon as a short-circuit is identified on the DALI cable when the mains power supply is switched on, the DALI Gateway transmits feedback to the KNX when the feedback function for DALI short-circuits is enabled.

The DALI Gateway uses the 1-bit communication object "Short-circuit in the DALI system" to feed back a DALI short-circuit. The telegram polarity of this object is fixed: No short-circuit = 0, Short-circuit = 1.

Setting feedback for DALI short-circuit

In the ETS configuration, it is possible to specify whether DALI short-circuit feedback is to be transmitted to the KNX. When enabled, telegram transmission is always actively transmitting. As soon as a short-circuit has been detected and eliminated, the Gateway will transmit one feedback telegram without a delay. The parameter "Feedback DALI short-circuit ?" in the "General -> DALI error messages" parameter node defines the behaviour of mains voltage monitoring.

- Set the parameter to "yes".
The DALI short-circuit feedback is activated and the communication object enabled.

- Set the parameter to "no".
The DALI short-circuit feedback is deactivated. The communication object is hidden.

- i** The connected DALI operating devices also react to a short-circuit in the DALI cable. The devices set themselves to the specified "System Failure Level". By default, this brightness value is defined by the "Behaviour in case of bus voltage failure" parameter of a group or a single device. Optionally, this value can - irrespective of the behaviour in case of bus voltage return - be set to a separate brightness value for emergency operation . (see page 155).
- i** Since the brightness of the connected DALI operating devices might possibly change if there is a short-circuit, the DALI Gateway also transmits feedback to the bus for the switching status and brightness value if these feedback functions are enabled.
- i** The feedback of a DALI short-circuit can only be transmitted when the bus voltage is connected and switched on at the time of the short-circuit. If no bus voltage is connected or switched on at the time of the short-circuit, no feedback for mains voltage return will be transmitted either. Feedback is saved, however, which means that it is transmitted later when the bus voltage is switched on.
- i** The DALI Gateway initialises after switching on the mains power supply or after an ETS programming operation. If a short-circuit on the DALI cable is detected in this state, the Gateway will immediately transmit an appropriate feedback telegram. After bus voltage return (mains voltage switched-on permanently on the DALI Gateway during bus failure), the feedback is not sent to the bus automatically.

4.2.4.2.3 Status and feedbacks

Delay after bus/mains voltage return

To reduce telegram traffic on the bus line after the bus voltage (bus reset) or the mains voltage supply is switched on, after connection of the device to the bus line or after programming with the ETS, it is possible to delay all actively transmitted feedback telegrams of the Gateway. To do this, a delay time can be specified for multiple functions (parameter "Time delay for feedbacks after bus return for groups and devices" in the parameter node "General -> Status and feedback"). Only after the configured time elapses are feedback telegrams for initialisation transmitted to the bus.

It is possible to configure separately which of the feedback telegrams are actually delayed for each feedback function.

- i** The delay has no effect on the behaviour of the individual groups or single devices and not on other functions of the device either. Only the feedback telegrams are delayed. Groups and single devices can also be activated during the delay after bus voltage return.
- i** A setting of "0" for the delay after bus voltage return deactivates the delaying function altogether. In this case, all feedback telegrams, if actively transmitted, will be transmitted to the bus without any delay.
- i** The messages "Error status in DALI system", "Error status per DALI operating device" (only 1 byte), "Short-circuit in the DALI system" or "Voltage failure in the DALI system" are always transmitted without a time delay.

Delaying feedback

Only feedbacks that are enabled and set as actively transmitting can be configured with regard to the transmitting behaviour after bus voltage return.

- Set the parameter "Time delay for feedback telegram after bus voltage return" to "yes". The parameter is on the parameter page of the corresponding switching status or brightness value feedback of a group or a single device.

In this case, after bus voltage return the feedback telegram is first transmitted to the bus after the end of the delay time. Alternatively (setting "No"), a feedback telegram is transmitted to the bus without time delay immediately after bus voltage return .

Collective feedback

After central commands or after bus/mains voltage return, a KNX line is generally heavily loaded by data traffic as many bus devices are transmitting the state of their communication objects by means of feedback telegrams. This effect occurs particularly when using visualisations.

Collective feedback of the Gateway can be used to keep the telegram load low during initialisation.

The collective feedback summarises the switching states of the DALI groups and single devices in bit-orientated form (figure 28). Up to 6 separate 4-byte communication objects according to KNX DPT 27.001 are available for this, depending on the set addressing type. Each of these objects can visualise the switching state of up to 16 groups or devices.

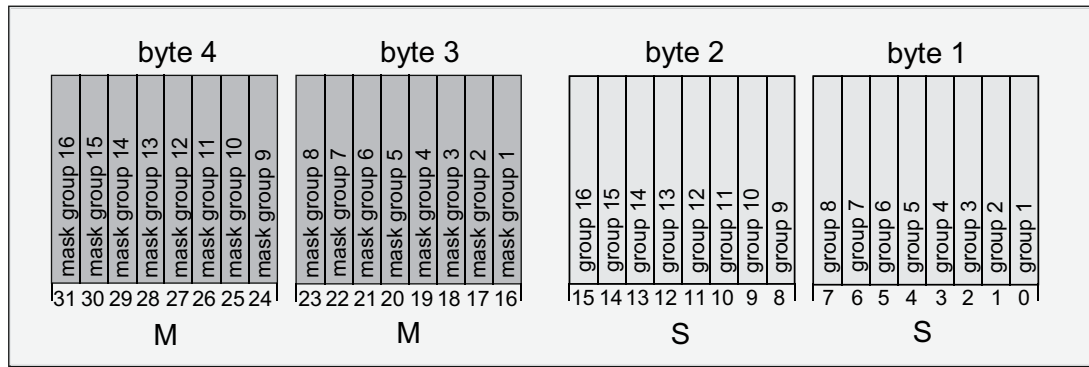

Figure 28: Structure of the objects of the collective feedback, using the example of the object for Groups 1-16

It is possible to show up to 16 groups or single devices and thus up to 16 different switching states logically in a 4-byte object. Each group or each single device has one bit representing the switching state ("S" bit) and another one defining the masking ("M" bit). The "S" bits correspond to the logical non-inverted switching states of the groups or devices and are either "1" (on) or "0" (off). The M bits are "1" when the corresponding group or the appropriate single device has been created in the project design of the Gateway. Similarly, M bits are "0" when groups or devices are not available. In this case, the corresponding "S" bits are continuously "0", as there is no switching status.

After a device reset (ETS programming operation, bus or mains voltage return), the Gateway always transmits all the collective feedback according to the configured addressing type, provided that the objects are configured as actively transmitting. If only individual switching states change in Gateway operation, only the affected collective feedback objects are updated.

The following example object value formats result...

Groups 1 to 4 available: "00 0F 00 0x", x = switching states

-> Group 1 and 2 ON: "00 0F 00 03" / Group 1 and 3 ON: "00 0F 00 05"

Groups 1 to 6 available: "00 3F 00 xx", x = switching states

-> Group 1 and 2 ON: "00 3F 00 03" / Group 1 and 5 ON: "00 3F 00 11"

Groups 1 to 4 and 10 to 12 available: "0E 0F 0x 0x", x = switching states

-> Group 1 and 4 ON: "0E 0F 00 09" / Group 1 and 10 ON: "0E 0F 02 01"

Use of the collective feedback would be possible in appropriate visualisation applications - for example in public buildings such as schools or hospitals - where the switching states of the actuators are displayed centrally and no separate switching status is displayed at the control sections. In such applications the collective feedback can replace the 1 bit individual feedbacks and thereby significantly reduce the bus load.

Activate collective feedback

Collective feedback is a global device function and can be enabled in the parameter node "General -> Status and feedback".

- Set the parameter "Collective feedback switching status ?" to "yes".

Collective feedback is enabled. The collective feedback objects become visible in the ETS. Depending on the configured addressing type, up to 6 objects are displayed for groups and / or single devices.

- Set the parameter to "no".
Collective feedback is deactivated. No collective feedback objects are available.

Setting the update of collective feedback

In the ETS plug-in, you can specify when the Gateway should update the feedback values for the collective feedback, in the case of an actively transmitting communication object. The object value updated by the Gateway is then signalled actively to the bus.

The parameter "Updating of the object value for collective feedback" is created in the parameter node "General -> Status and Feedback".

Collective feedback must be enabled and the feedback type set to "Active message object".

- Set the parameter to "After each update of the inputs".
The Gateway updates the feedback values in the collective feedback once a new telegram is received on the input objects "Switching" or "Central switching" for groups or single devices. With actively transmitting feedback objects, a new telegram is also then actively transmitted to the bus each time. The telegram value of the feedback does not necessarily have to change in the process. Hence, corresponding collective feedbacks are also generated, e.g. for cyclical telegrams to the "Switching" objects.
- Set the parameter to "Only if the feedback value changes".
The Gateway only updates the feedback values in the collective feedback objects when the telegram values of the inputs also change. If telegram values of the feedback do not change (e.g. in the case of cyclical telegrams to the "Switching" objects with the same telegram value), the feedback then remains unchanged. Consequently, in the case of actively transmitting feedback objects, no telegram with the same content will be transmitted repeatedly either.

Collective feedback type

Collective feedback can take place in the form of active message objects or passive status objects. In the case of active message objects, the feedback is transmitted to the bus whenever the status contained therein changes. In the function as a passive status object, there is no automatic telegram transmission. In this case, the object values must be read out. The ETS automatically sets the communication flags of the objects required for proper functioning.

Collective feedback must be enabled.

- Set the parameter "Type of collective feedback" in the parameter node "General -> Status and Feedback" to "Active signalling object".
The Gateway transmits the collective feedback automatically when the object value is updated. After a device reset (ETS programming operation, bus or mains voltage return), all the collective feedback is transmitted according to the configured addressing type. If only individual switching states change in Gateway operation, only the object values of the affected collective feedback objects are transmitted to the bus as well.
- Set the parameter to "Passive status object".
Collective feedback will only be transmitted in response if the appropriate object is read out from the bus. No automatic telegram transmission of the collective feedback takes place after bus or mains voltage return or after programming with the ETS.

Setting collective feedback after bus/mains voltage return or after programming with the ETS

If used as an active message object, the states of the collective feedback are transmitted to the bus after bus or mains voltage return or after programming with the ETS. In these cases, the

feedback telegram can be time-delayed with the delay being preset globally for all groups and single devices together (see page 68).

Collective feedback must be enabled and the feedback type set to "Active message object".

- Set the parameter "Time delay for feedback telegram after bus voltage return" to "Yes".
The collective feedback objects are transmitted with a delay after bus or mains voltage return or after programming with the ETS. No feedback telegram is transmitted during a running delay, even if a switching state changes during this delay.
- Set the parameter "Time delay for feedback telegram after bus voltage return" to "no".
The collective feedback is transmitted immediately after bus or mains voltage return or after programming with the ETS.

Setting cyclic transmission of the collective feedback

The objects of the collective feedback can also transmit their value cyclically in addition to transmission when updating.

Collective feedback must be enabled and the feedback type set to "Active message object".

- Set the parameter "Cyclical transmission of feedback telegram?" to "yes".
Cyclical transmission is activated.
 - Set the parameter "Cyclic transmission of the collective feedback ?" to "no".
Cyclical transmission is deactivated which means that collective feedback is only transmitted to the bus if one of the switching states changes.
- i** The cycle time for all cyclic feedback telegrams is defined centrally on the same parameter page.
- i** During an active delay after bus voltage return no collective feedback telegram will be transmitted even if a switching state changes.

4.2.4.2.4 Global switching status / Standby switch-off

The DALI Gateway offers a function for global feedback of the switching status of all planned DALI groups and devices. This feedback can also be used for standby switch-off of the DALI system, and thus to save energy.

The global switching status feedback is a general device function and can be enabled as necessary in the ETS plug-in in the parameter node "General -> Standby switch-off of DALI devices". If the function is enabled, the 1-bit object "Standby switch off DALI/Global switching status" becomes visible. The object value is "ON" if at least one DALI group or one DALI single device is switched on (brightness value > 0). The object value is "OFF" if all the DALI groups or DALI single devices are switched off (brightness value = 0). Here, it is not important what switched a group or individual on or off. A KNX command to objects in the groups or devices, recall of a scene or the start of an effect affect the updating of the global switching status feedback.

- i** When the global switching status is evaluated, the logical switching status of a DALI group or a single device is evaluated. It is irrelevant whether all or individual planned groups or devices were assigned electronic ballasts during DALI commissioning, or whether assigned electronic ballasts can be contacted.

The object value "OFF" of the feedback can optionally be sent to the bus after a delay, using the parameter "Delay until activation of the standby switch-off / transmit the feedback?". If the delay time is used, the feedback telegram can be used for standby switch-off of the DALI system. For this, for example, an output of a KNX switching actuator used as an NO contact should be connected to the feedback object of the DALI Gateway. The output of the switching actuator switches the mains voltage supply of all the DALI operating devices (figure 29). If the global switching status in this application is "OFF", the (delayed) telegram to the actuator will disconnect all the DALI operating devices (not the DALI Gateway) from the network, saving electrical energy. The mains voltage is switched on automatically with the feedback telegram "ON", as soon as the Gateway is to switch on at least one operating device by DALI command. The time between the transmission of this feedback (switching on the mains voltage) and the transmission of the DALI command can be delayed optionally using the parameter "Delay until restart of the DALI devices?". This gives the DALI operating devices sufficient time after the return of the mains voltage to initialise themselves in order to be able to react properly to the commands of the Gateway.

- i** When centrally-supplied DALI emergency lights are controlled, the global switching status may not be used for standby switch-off! Therefore, it is not possible to set the parameters "Delay until activation of the standby switch-off / transmit the feedback?" and "Delay until restart of the DALI devices?" to "yes" if the integration of emergency lights is intended. When emergency operation is used, the global switching status feedback can only be transmitted without delay for general purposes of visualisation. The transmission of DALI commands after a mains voltage return can also only take place without a delay.
- i** If, during the course of a delay, additional telegrams are received via KNX until the restart of the DALI devices, then only the most recently received telegram is forwarded to the DALI system after the delay time has elapsed.
- i** When using the delay until the restart of the DALI devices, ensure that the parameter "Behaviour after bus voltage return" (corresponds to the DALI power-on level) of a group or a single device is configured as "Switch off". This means that the affected devices do not switch-on directly when the mains voltage returns but only after they have received an appropriate DALI command from the Gateway via the DALI cable.
- i** During a standby switch-off, the DALI Gateway does not evaluate any DALI error status of the programmed operating devices.
- i** Observe the current carrying capacity of the KNX switching actuator integrated into the standby switch-off! If necessary, use additional installation contactors. We do not recommend using multiple actuator channels, as it is usually not possible to implement simultaneous switching of all the channels.

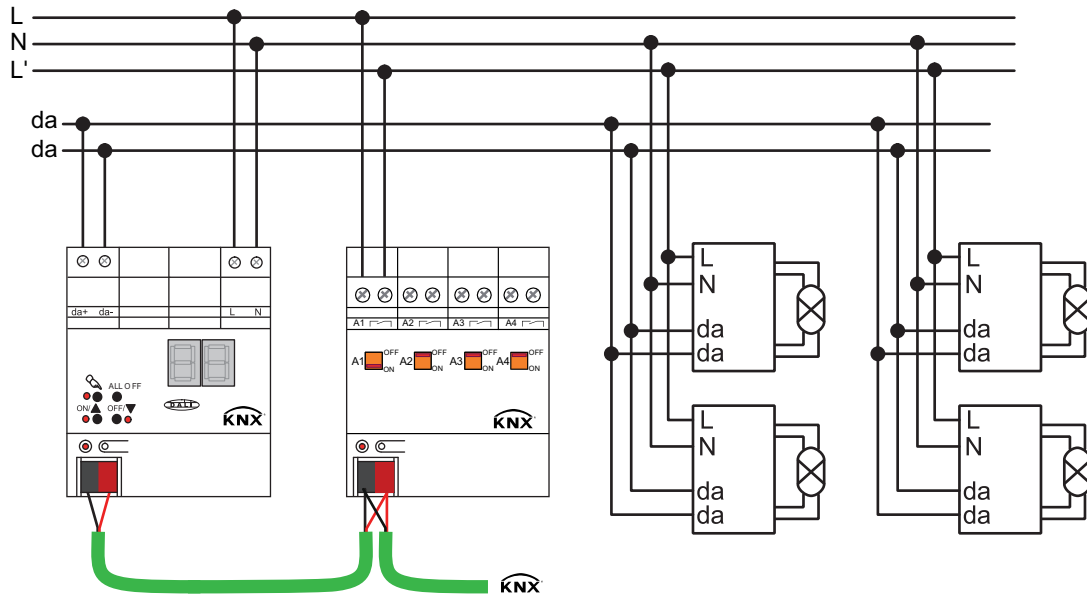

Figure 29: Example of a connection diagram for standby switch-off by a KNX switching actuator

When the standby switch-off is used (active time delays), the feedback of the global switching status will always take place as an active message telegram whenever the feedback value changes. If no time delay has been configured (global switching status for general visualisation purposes), the feedback object - according the parameter "Type of feedback" - can either be used as an active signalling object or, alternatively, as a passive status object. As an active message object, the feedback information is also directly transmitted to the bus whenever there is an update. As a passive status object, there is no telegram transmission after an update. In this case, the object value must be read out. The ETS automatically sets the object communication flags required for proper functioning.

If used as an active message object, the feedback status is transmitted to the bus after bus/mains voltage return or after programming with the ETS, if switch-on or switch-off takes place after a device reset. If feedback is not used for standby switch-off, the telegram can be transmitted after a delay after bus/mains voltage return, whereby the delay time is set jointly and globally for all the feedback of the device. If a time delay is required, the parameter "Time delay for feedback after bus voltage return ?" must be set to "yes". Otherwise ("no" setting), transmission of the active message telegram takes place immediately after a device reset and thus generally when the standby switch-off is used.

Feedback in its function as an active signalling object can also be transmitted cyclically as an option in addition to transmission when the object value changes, although this is only possible if the delay times, and thus the standby switch-off, are not used. The parameter "Cyclical transmission of feedback telegram ?" then specifies if cyclical transmission is enabled or not. If enabled, the parameter "Time for cyclical transmission" on the same parameter page will define the cycle time.

- i** After a device reset (mains voltage failure and return on Gateway, ETS programming operation), the groups and devices set themselves to the specified behaviour after initialisation (parameter "Behaviour after bus voltage return" or KNX telegram). If an active switch-off or switch-on occurs on a brightness value, the Gateway will also transmit global status feedback according to the current state (possibly after a delay).

4.2.4.2.5 Manual operation

The DALI Gateway offers manual operation for all the available DALI groups and single devices. The button field with 4 function keys and 3 status LEDs on the front panel of the device can be used for setting the following modes of operation...

- Bus control: operation from touch sensors or other bus devices
- Temporary manual control: manual control locally with keypad, automatic return to bus control,
- Permanent manual control: local manual control with keypad.

The operation of the function keys, the control of the outputs and the status display are described in detail in chapter "Operation". (see page 14-15). Configuration, status feedback, disabling via a bus telegram and interaction with other functions of the DALI Gateway when manual operation is activated and deactivated will be described in greater detail in the following sections.

Manual operation is possible only when the mains voltage supply to the Gateway is switched on. In the delivery state of the DALI Gateway, manual operation is fully enabled. In this unprogrammed state, all connected DALI operating devices can be controlled using the broadcast function so that fast function checking of the connected electronic ballasts (e.g. on the construction site) is possible.

After initial commissioning of the Gateway via the ETS, manual operation can be enabled or disabled separately for various states of operation. Manual control can, for instance, be disabled during bus operation (bus voltage applied). Another option consists in the complete disabling of the manual control only in case of bus voltage failure. Therefore manual control can be disabled completely, if the bus disable and bus failure disable are active.

- i** The colour temperature of a DALI group or single device cannot be changed by manual operation.

Enabling the manual control mode

Manual control for the different states of operation is enabled by means of the parameters "Manual control in case of bus voltage failure" and "Manual control during bus operation".

- Set the parameter "Manual control in case of bus voltage failure" to "enabled".
Manual control is then basically enabled when the bus voltage is off. This setting corresponds to the setting of the actuator as delivered.
- Set the parameter "Manual control in case of bus voltage failure" to "disabled".
Manual control is completely disabled when the bus voltage is off. Since bus operation is also not possible in this state, the DALI groups of the Gateway can no longer be controlled.
- Set the parameter "Manual control during bus operation" to "enabled".
Manual control is then basically enabled when the bus voltage is on. The DALI groups and single devices of the Gateway can be controlled via the bus or by manual operation. This setting corresponds to the setting of the actuator as delivered.
- Set the parameter "Manual control during bus operation" to "disabled".
Manual control is completely disabled when the bus voltage is on. In this configuration, the DALI groups and the single devices of the Gateway can only be operated via the bus.

- i** Manual control is possible only while the actuator is supplied with power from the mains. Manual operation ends in case of bus voltage failure, bus voltage return or mains voltage failure.

- i** Further parameters and communication objects of the manual control are visible only in the configuration "Manual control during bus operation = enabled". For this reason, the disabling function, the status message and bus control disabling can only be configured in the above parameter setting.

Presetting the behaviour at the beginning and at the end of manual control

The manual control distinguishes the temporary and permanent manual control. The behaviour is different depending on these modes of operation, especially at the end of manual control. It should be noted that bus operation, - i.e. control of the DALI groups and single devices by direct operation (switching / dimming / brightness value / scenes / central) or by the disabling or forced position functions - is always disabled during activated manual operation. This means that the manual control mode has the highest priority.

Behaviour at the beginning of manual control:

The behaviour at the beginning of manual control does not differ for temporary and permanent manual control. During activation of the manual operation, the brightness statuses of the DALI groups and single devices remain unchanged. Flashing feature during disabling function: The flashing of a disabling function is interrupted at the beginning of the manual operation. The brightness remains at the most recently set flash state ("ON" or "OFF"). The switching status is indicated as "ON". Active forced position functions or disabling functions can be overridden by manual control. These functions are reactivated after deactivation of the manual mode unless they have been cancelled in the meantime.

Behaviour at the end of manual control:

The behaviour at the end of manual control is different for temporary and permanent manual control. Temporary manual operation mode is shut off automatically when the last group or - if single devices are configured - the last single device has been addressed and when the select key  is pressed once again. During deactivation of the temporary manual operation mode, the Gateway returns to 'normal' bus operation and does not change the brightness states selected by manual control. However, if a forced position or disabling function was activated via the bus before or during manual operation of emergency operation, the Gateway executes these functions of a higher priority again for the groups and single devices concerned.

The permanent manual control mode is shut off, when the select key  is pressed for more than 5 seconds. Depending on the configuration of the Gateway in the ETS, the groups will be set to the state last adjusted in manual operation or to the state internally tracked (direct operation, forced position, disabling) when the permanent manual operation is switched off. The parameter "Behaviour at the end of permanent manual control during bus operation" defines the corresponding reaction.

- Set the parameter "Behaviour at the end of permanent manual control during bus operation" to "no change".

All telegrams received during an active permanent manual control mode for direct operation (switching, dimming, brightness value, central, scenes) will be rejected. After the end of the permanent manual control mode, the current brightness state of all the groups and single devices remains unchanged. If, however, a forced position or disabling function was activated via the bus before or during manual operation of emergency operation, the Gateway executes these functions of a higher priority again for the groups concerned.

- Set the parameter "Behaviour at the end of permanent manual control during bus operation" to "track outputs".

During active permanent manual control all incoming telegrams are tracked internally. At the end of manual operation, the groups and single devices are set to the last tracked brightness states. If a forced position or disabling function was activated via the bus before or during manual operation of emergency operation, the Gateway executes these functions of a higher priority again for the groups and single devices concerned.

- i** The behaviour at the end of the permanent manual control when the bus voltage is off (only manual control) is permanently set to "no change".
- i** The control operations triggered in the manual control mode will be transmitted via feedback objects to the bus, if enabled and actively transmitting.

- i** On failure/return of bus voltage or after programming with the ETS, an activated manual operation mode will always be terminated. In this case, the parameterised or predefined behaviour at the end of manual control will not be executed. Instead, the Gateway executes the configured behaviour on bus/mains voltage return or after ETS programming.

Presetting a manual control disable

The manual control mode can be separately disabled via the bus, even if it is already active. If the disabling function is enabled, then as soon as a disabling telegram is received via the disabling object, the Gateway immediately terminates an activated manual operation and locks the function keys on the front panel of the device. The telegram polarity of the disabling object is parameterisable.

The manual control mode during bus operation must be enabled.

- Set the parameter "Disabling function manual control ?" on parameter page "Manual control" to "yes".
The disabling function of the manual control mode is enabled and the disabling object is visible.
- Select the desired telegram polarity in the "Polarity of the manual operation disabling object" parameter.
- i** In the polarity "1 = enabled / 0 = disabled", the disabling function is immediately active on return of bus/mains voltage or after an ETS programming operation (object value = "0"). To activate the manual control in this case, an enable telegram "1" must first be sent to the disabling object.
- i** In case of bus voltage failure, disabling via the disabling object is always inactive (depending on parameterization, the manual control is then either enabled or completely disabled). After return of bus voltage, a disabled state that was active beforehand is always inactive when the polarity of the disabling object is non-inverted.
- i** In the event of failure of the supply voltage (mains voltage failure), disabling is deactivated via the disabling object.
- i** When an active manual control is terminated by a disable, the actuator will also transmit a "Manual control inactive" status telegram to the bus, if the status messaging function is enabled.
- i** The "Automatic device replacement" function is not influenced by the disabling function of the manual operation.

Presetting the status message function for the manual control mode

The DALI Gateway can transmit a status message to the bus via a separate object when the manual operation is activated or deactivated. The status telegram can only be transmitted when the bus voltage is switched on. The polarity of the status telegram can be parameterised.

The manual control mode during bus operation must be enabled.

- Set the parameter "Status manual control ?" on parameter page "Manual control" to "yes".
The status messaging function of manual control is enabled and the status object is visible.
- Specify in the parameter "Status object function and polarity" whether the status telegram is generally a "1" telegram whenever the manual control mode is activated or only in those cases where the permanent manual mode is activated.
- i** The status object is always "0" when the manual control mode is deactivated.
- i** The status is only transmitted actively to the bus ("0") after return of bus voltage when an activated manual control is ended by the bus return during the bus voltage failure. The status telegram is in this case transmitted without delay.

- i** When active manual control is terminated by a disable, the actuator will also transmit a "Manual control inactive" status telegram to the bus.

Setting disabling of the bus control

Individual DALI groups and single devices can be disabled locally so that the disabled DALI operating devices can no longer be controlled via the KNX. Such disabling of the bus operation is initiated by local operation in permanent manual operation and is indicated by flashing of the group or single device number in the 7-segment display. The disabled groups and single devices can then only be activated in permanent manual operation.

The manual control mode during bus operation must be enabled.

- Set the parameter "Bus control of individual groups or single devices can be disabled ?" on parameter page "Manual control" to "yes".

The function for disabling the bus control is enabled and can be activated locally. Alternatively, this parameter can be set to "no" to prevent disabling of the bus control from being activated in permanent manual operation.

- i** The disabling initiated locally has the highest priority. Thus, all other functions of the Gateway that can be activated via the bus (e.g. emergency operation, forced position or disabling function) are overridden. Depending on the configuration of the Gateway in the ETS, the groups and single devices will be set to the state last adjusted in manual operation or to the state internally tracked (direct operation, emergency operation, forced position, disabling) when permanent manual operation is disabled and subsequently switched off.
- i** Any disabling of the bus control activated locally is not reset in case of bus voltage failure or return. A failure of the supply voltage (mains voltage failure) or an ETS programming operation always deactivates disabling of the bus control.

DALI device replacement

After starting the automatic device replacement, the DALI Gateway is able to check the completeness of the previously operated DALI operating devices. If, for example, a defective DALI electronic ballast was removed by an installation engineer and replaced by a new one, the DALI Gateway is able to program the new electronic ballast with the programming data of the failed electronic ballast. This makes it possible to replace a failed DALI operating device by a simple operation on the device and without any configuration work in the ETS.

- i** When using the automatic device replacement, only operating devices of the same DALI type can be interchanged! If operating devices of another type are to be replaced, a complete DALI commissioning must be carried out using the ETS plug-in.

Activation of the automatic device replacement and the steps necessary to perform the replacement operation are described in detail in the "Operation" chapter of this documentation (see page 15). The section below documents the ETS configuration of this function.

Setting enabling for DALI device replacement

In the ETS configuration, it is possible to specify whether or not an automatic device replacement can be executed through local control on the DALI Gateway.

- Set the parameter "Enable DALI device replacement through manual operation ?" on the parameter page "General" to "yes".
Automatic DALI device replacement can be initiated and executed through local control on the DALI Gateway.
- Set the parameter "Enable DALI device replacement through manual operation ?" to "no".

Automatic DALI device replacement is not possible. The operating function is disabled locally.

- i During automatic device replacement, all the other functions of the DALI Gateway are stopped. During device replacement, the Gateway tracks all the received bus states and evaluates the most recently tracked values (switching, dimming, brightness value, scenes, effects, central function, emergency operation, forced position, disabling function) normally at the end of automatic device replacement. Active emergency operation or an active forced position or disabling function is interrupted by device replacement and reactivated at the end of the replacement operation if the functions have not been deactivated in the meantime. The behaviour as at the beginning of the forced position or disabling function is not executed again.
- i Automatic device replacement can also be executed when manual operation is disabled.

4.2.4.2.6 Central function

Central function

The Gateway offers the possibility of linking selected individual or all groups and single devices with a 1-bit central communication object. The behaviour in case of activation via the central function is comparable to a central group address linked with all "Switching" objects. The groups and single devices assigned to the central function are activated in accordance with the central object value received. The polarity of the central telegram can be configured as inverted.

The behaviour of the groups and devices is identical to the normal control via the "Switch" objects (same priority – last switching command is executed). Thus, all downstream functions, such as timing/supplementary functions, are also taken into account.

Enabling the central function

- Enable the central function on parameter page "General" by setting the "Central function ?" to "Yes".
If a function is active, the "Central function for groups and devices" communication object is visible.

Assigning groups and single devices to the central function

Each DALI group and each planned single device can be assigned to the central function independently. The central function must have been enabled on parameter page "General". Otherwise, no assignment is possible.

- Set the Parameter "Assignment to central function ?" in the parameter node "Addressing -> Groups ... - [x] Group name - Switching" or "Addressing -> Single devices ... - [x] Device name – Switching" to "yes".
The group or the single device is assigned to the central function. The assigned DALI operating devices can be switched on or off centrally.
- ⓘ The switching state set by the central function is tracked in the feedback objects and also transmitted to the bus, if these are actively transmitting. The switching state set by a central function is not tracked in the "switching" objects.
- ⓘ After a bus/mains voltage return or after programming with the ETS, the central function is always inactive (object value "0").

4.2.4.3 Description of group and device functions

4.2.4.3.1 Controlling the brightness

Settable brightness range

The settable brightness range of a DALI group or a single device can be limited by defining a lower and upper brightness value. The parameters "Minimum brightness" and "Maximum brightness" in the parameter node "Addressing -> Groups -> [x] Group name" (x = Group number 1...32) or "Addressing -> Single devices -> [x] Device name" (x = Short address 1...64) specify the brightness values, which may not be undershot or exceeded when presetting a brightness value or dimming operation. In this way, the brightness of the controlled lamps of the DALI operating devices can be adapted individually – even to the brightness sensitivity of the human eye. The configured minimum brightness can be undershot only by switching off or when dimming up starting from the "OFF" state.

Furthermore, the brightness value, which is set whenever switching on via the "Switching" or the "Central function switching" object on the DALI operating devices, can be predefined. The parameter "Switch-on brightness" defines this brightness separately for each group and each single device. The settable value is anywhere between the minimum and maximum.

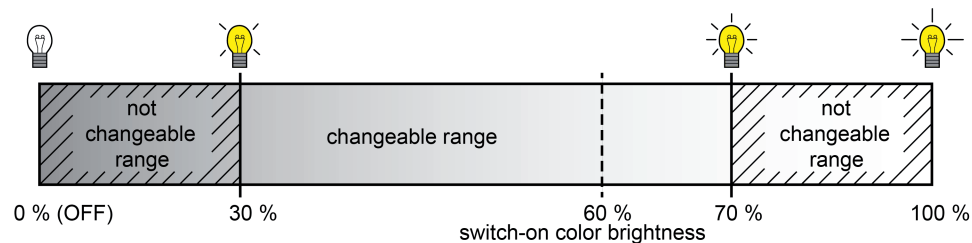

Figure 30: Example of a brightness range with switch-on brightness

Setting the minimum brightness

The minimum brightness can be set separately for each DALI group and each single device.

- Set the "Minimum brightness" parameter in the parameter node "Addressing -> Groups ... -> [x] Group" or "Addressing -> Single devices ... -> [x] Electronic ballast" to the required brightness value.

The set brightness is not undershot when predefining a brightness value or during a dimming operation in the "ON" state. The configured minimum brightness can be undershot during the dimming operation only by switching off or when dimming up starting from the "OFF" state.

- i** The upper limit of the settable value selection is limited by the configured maximum brightness (minimum brightness < maximum brightness).
- i** During editing of the minimum brightness, the ETS plug-in checks all the configured brightness values of the group or the single device (e.g. switch-on brightness, scene values) to determine whether the values undershoot the minimum brightness. If this is the case, the plug-in will signal a value conflict and offer the following selection...
 - the brightness values can be adjusted to the minimum brightness, or
 - the minimum brightness setting is reset to its original value.
- i** If values are received by the brightness value object and are less than the configured minimum brightness, then the Gateway will set the minimum brightness as the new brightness value for the group or single device concerned.

Setting the maximum brightness

The maximum brightness can be set separately for each DALI group and each single device.

- Set the "Maximum brightness" parameter in the parameter node "Addressing -> Groups ... -> [x] Group" or "Addressing -> Single devices ... -> [x] Electronic ballast" to the required brightness value.

The set brightness is not undershot in any switched-on operating state.

- i** The lower limit of the selection of the value settable is limited by the configured minimum brightness (minimum brightness < maximum brightness).
- i** During editing of the maximum brightness, the ETS plug-in checks all the configured brightness values of the group or the single device (e.g. switch-on brightness, scene values), to see if the values exceed the maximum brightness. If this is the case, the plug-in will signal a value conflict and offer the following selection...
 - the brightness values can be adjusted to the maximum brightness, or
 - the maximum brightness setting is reset to its original value.
- i** If values are received by the brightness value object and are greater than the configured maximum brightness, then the Gateway will set the maximum brightness as the new brightness value for the group or single device concerned.

Setting the switch-on brightness

The switch-on brightness can be set separately for each DALI group and each single device.

- Set the "Switch-on brightness" parameter in the parameter node "Addressing -> Groups ... -> [x] Group" or "Addressing -> Single devices ... -> [x] Electronic ballast" to "Brightness value". In the selection box, configure the necessary brightness value.

The set brightness is set after receipt of an ON telegram via the "Switching" communication object or after receipt of a central telegram with the polarity "Activated" by the assigned operating devices.

- Set the parameter "Switch-on brightness" to "Memory value (brightness before switching off last time)".

On switch-on, the active and internally-saved brightness value prior to switching off last time is set (via the "Switching" or "Central function switching" object). This memory value is saved in the volatile memory, which means that the value is predefined to maximum brightness after a bus or mains voltage return or an ETS programming operation.

- i** In the "Brightness value" setting: The selection of the settable value is limited to the configured minimum brightness at the lower limit and by the configured maximum brightness at the upper limit.
- i** A memory value is also then saved internally by a switch-off telegram if the bus-controlled switch-off is overridden, for example, by a disable or forced position function or by a manual operation. In this case, the internally tracked brightness value is saved as memory value.
- i** If no soft ON function is activated, the brightness value is more or less jumped to when switching on (using minimum DALI fading of 0.7 seconds). Once a soft ON function is activated, the switch-on brightness is dimmed according to the dimming speed for the soft ON function.

Dimming characteristic and dimming speeds

The brightness of operating devices of a DALI group or a configured single device can be changed by a dimming operation. The limits of the brightness range that can be set by a dimming operation are defined by the maximum brightness and minimum brightness predefined in the ETS.

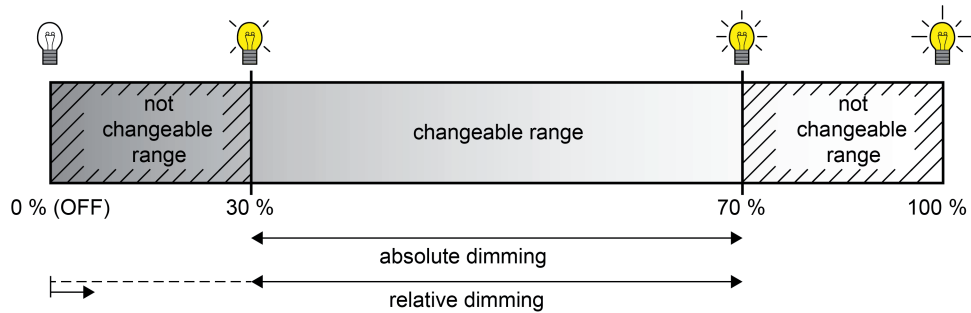

Figure 31: Example of a dimmable brightness range

A DALI group or single device can be dimmed by...

- **Relative dimming:**
Relative dimming can either be triggered by the 4-bit "dimming" communication object available for each group or single device or by a long button-press of the manual operation. The data format of the "dimming" object complies - as is normal with KNX dimming actuators - with the KNX standard DPT 3.007, which means that the dimming direction and relative dimming increments can be predefined in the dimming telegram or dimming procedures can also be stopped. In relative dimming by local manual operation on the DALI Gateway, a dimming procedure is executed whilst the appropriate button is pressed. The dimming process ends when the button is released or when the maximum brightness or minimum brightness is reached. A relative dimming operation allows a brightness value to be changed constantly and always starts from the brightness that is set at the time of the dimming command.
When dimming up starting from the "OFF" state, the configured minimum brightness can be undershot during the dimming operation.
In the plug-in of the DALI Gateway, the dimming speed for relative dimming can be configured separately for each group and each single device.
- **Absolute dimming:**
Absolute dimming is triggered by specifying a brightness value. This value can be predefined by the 1-byte "Brightness value" communication object of the KNX, which is available separately in each group or single device. In addition, brightness values can also be set by a disabling or forced position function or by the effect function. Absolute dimming can also be activated, even in case of bus voltage failure, after bus or mains voltage return or after programming with the ETS, by specifying brightness values.
When predefining a brightness value via the object, by a scene recall or by an effect step, it is possible to configure (separately for each) in the ETS plug-in whether the value is jumped to directly or alternatively whether it is dimmed to using a dimming time. In the case of all other absolute dimming functions, the brightness values are always instantly jumped to.

i Even if brightness values are instantly jumped to, the dimming procedure on DALI operating devices always takes a very short time as well as when switching without soft ON or soft OFF. This dimming procedure is dependent on the system. The brightness value jumped to will be dimmed to within 0.7 seconds (short fading). This time cannot be altered.

On the DALI Gateway, the setting of a dimming time for relative dimming or absolute dimming (with dimming of the brightness values) can take place for the entire possible DALI brightness range, depending on the system. The time entered in the ETS defines the maximum length for dimming over the entire brightness range of the DALI data value "0 (0 %)" to "254 (100 %)". The dimming step times can be derived from the configured times.

Examples:

Configured time for relative dimming = 10 seconds / set brightness value = 50 % -> relative dimming from 50 % to 100 % -> the dimming operation takes 5 seconds.

Configured time for absolute dimming = 20 seconds / set brightness value = 25 % -> absolute dimming from 25 % to 100 % -> the dimming operation takes 15 seconds.

- i** When the dimming times are configured, the dimming time is always defined for the entire brightness range (0...100 %). A minimum or maximum brightness configured in the ETS does not limit the dimming times, but only specifies the dimmable range.

Setting dimming time for relative dimming

In the plug-in of the DALI Gateway, the dimming time for relative dimming can be set separately for each group and each single device.

- Set the parameter "Time for relative dimming (0...100 %)" in the parameter node "Addressing -> Groups ... - [x] Group -> Dimming" or "Addressing -> Single devices ... - [x] Electronic ballast -> Dimming" to the required dimming time.

Setting dimming behaviour for absolute dimming

In the plug-in of the DALI Gateway, the dimming behaviour for absolute dimming can be set separately for each group and each single device using the "Brightness value" object.

- Set the parameter "Dimming behaviour on receipt of a brightness value" in the parameter node "Addressing -> Groups ... - [x] Group -> Dimming" or "Addressing -> Single devices ... - [x] Electronic ballast -> Dimming" to "Dim to".

Once a new brightness value is received, it is set by means of the calculated dimming increment time for absolute dimming.

- Set the parameter "dimming behaviour after receipt of a brightness value" to "jump to". As soon as a new brightness value is received it will be instantly jumped to.

- i** Brightness values can also be set by a disabling or forced position function. Absolute dimming can also be activated, even in case of bus voltage failure, after bus or mains voltage return or after programming with the ETS, by specifying brightness values. In the case of these absolute dimming functions, the brightness values are always instantly jumped to. During a scene or effect recall, the dimming behaviour can be configured separately.

Setting dimming time for absolute dimming

In the plug-in of the DALI Gateway, the dimming time for absolute dimming can be set separately for each group and each single device using the "Brightness value" object.

The dimming behaviour must be configured as "Dim to".

- Set the parameter "Time for absolute dimming (0...100 %)" in the parameter node "Addressing -> Groups ... - [x] Group -> Dimming" or "Addressing -> Single devices ... - [x] Electronic ballast -> Dimming" to the required dimming time.

Dimming characteristic

The DALI Gateway converts KNX brightness values to DALI brightness values according to DPT 5.001 and brightness values that were configured in the ETS. On the DALI page, the brightness commands are transmitted in an 8-bit data value from the Gateway to the operating devices. This data value according to IEC 62386-102 is referred to as "Arc Power Level (APL)" in the DALI specification. The ideally dimmable brightness range on the DALI page is

represented in the data value by the decimal values 1...254. The value "0" is interpreted by the operating devices as "OFF". A value "255" means "no change of brightness" ("MASK").

The DALI specification also describes a logarithmic dimming characteristic. This characteristic determines how the 8-bit data value is converted by operating devices (e.g. electronic ballast for fluorescent lamps or LED drivers) to an equivalent luminous flux at the physical output via the connected luminaire. The luminous flux (physical unit "Lumen [lm]") is a measure for the light output emitted by a luminaire.

The dimming characteristic of the operating devices represents logarithmically the 8-bit data values transmitted on the DALI page to the luminous flux in the range 1...254. This range then corresponds to a physical light output of 0.1 %...100 %.

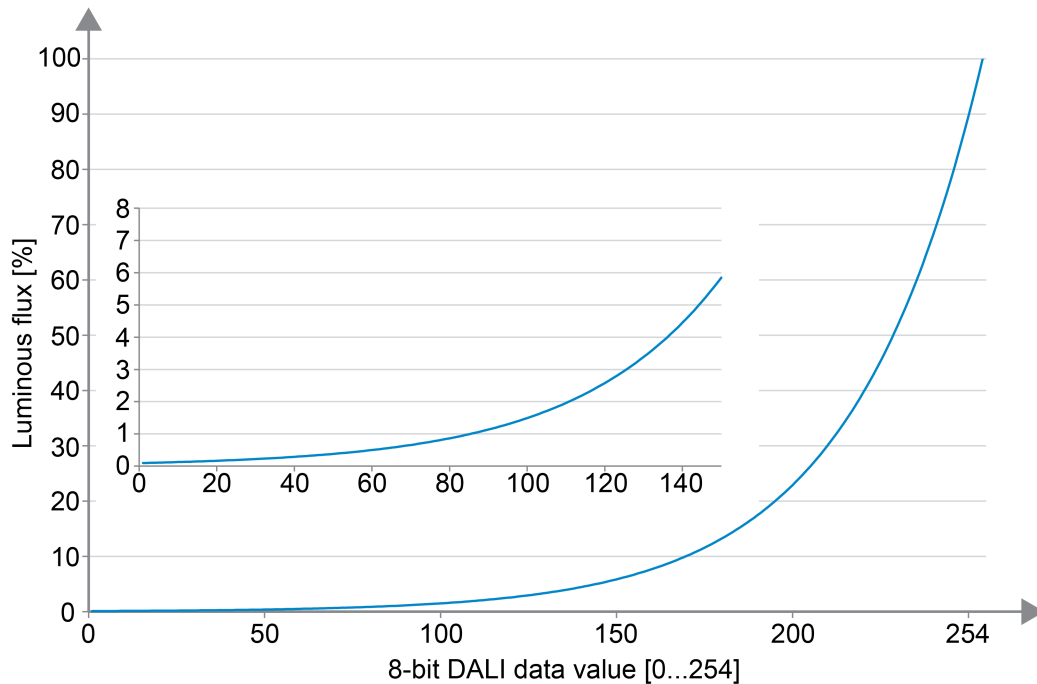

Figure 32: Logarithmic dimming curve in DALI operating devices (relative luminous flux [%] depending on the 8-bit DALI data value [0...254])

The logarithmic representation of the dimming values in the characteristic is used to adapt the emitted luminous flux to the subjective brightness sensitivity of the human eye. The human eye already perceives a far greater brightness at a luminous flux of 50 % (the luminaire emits half of its light output into the surrounding space). Brightness changes in the upper physically possible dimming range (> 50 % luminous flux) are hardly perceived anymore by the eye as a rule.

By using a logarithmic characteristic, the dimming range of the DALI data value is mapped in large parts on an area of the relative luminous flux where the human eye can optimally perceive brightness changes.

i The actual dimmable brightness range by a DALI operating device does not always have to correspond to the maximum possible DALI dimming range (0.1 %...100 %). On a DALI operating device the least adjustable brightness is referred to as "Physical Minimum Level (PHM)". This lower brightness limit value is defined by the physical properties of the operating device or connected luminaire and is normally specified in the manufacturer's datasheet.

The lower physical brightness limit value of an assigned operating device is independent of the adjustable minimum brightness in the ETS plug-in. It is quite possible to set a lower minimum brightness (e.g. 0.1 %) in the ETS than an operating device can actually set as a minimum (e.g. 3 %). In such cases, the Gateway dims to the configured minimum brightness via the DALI data value. The operating device or luminaire then already stops at the physical minimum, however. Ideally, the minimum brightness of a DALI group or single device is configured to the physical minimum of the operating device.

- i** A logarithmic dimming characteristic is standard in DALI operating devices and can normally be found in the delivery state. However, there are some operating devices, in which the characteristic curve can be adjusted - often by manufacturer-specific software tools. As a rule, it is possible to switch between a linear characteristic and a logarithmic characteristic.
- Such operating devices must always be set to a logarithmic characteristic in conjunction with the KNX DALI Gateway. Otherwise, the mechanism of the configurable characteristics of the DALI Gateway is incorrect!

When dimming, the logarithmic characteristic curve provided for DALI is not ideal for every control task. For this reason, the KNX DALI Gateway offers the possibility of influencing the DALI dimming characteristic without having to intervene in the operating devices. For this purpose, for each DALI group and single device in the ETS plug-in in the parameter node "Addressing -> Groups ... - [x] Group -> Dimming" or "Addressing -> Single devices ... - [x] Electronic ballast -> Dimming" the parameter "DALI dimming characteristic" is available.

- Linear DALI dimming characteristic:

In this setting, the Gateway linearises the DALI dimming characteristic by converting all brightness values, which are received from the KNX and configured in the ETS, appropriately into DALI data values. Thus, the KNX brightness values form linearly on the luminous flux emitted by the DALI luminaire. The Gateway itself does not dim linearly in this setting. A linear dimming sequence of the relative luminous flux first results at the physical output of an operating device through the combination of the non-linear conversion of the Gateway and the logarithmic characteristic of the operating devices. Feedbacks of the brightness value to the KNX are also adjusted through conversion. On account of the internal calculation process, there may be slight deviations between the specified and fed back brightness value (e.g. specification = 50 % -> Feedback = 49 %).

Example of brightness change:

KNX brightness: 50 % -> DALI data value (APL): 229 -> Luminous flux: approx. 50 % -> The human eye already perceives an intensive brightness.

KNX brightness: 75 % -> DALI data value (APL): 243 -> luminous flux: approx. 75 % -> The human eye hardly perceives the brightness difference between the previous dimming setting anymore. The dimming operation appears unsteady.

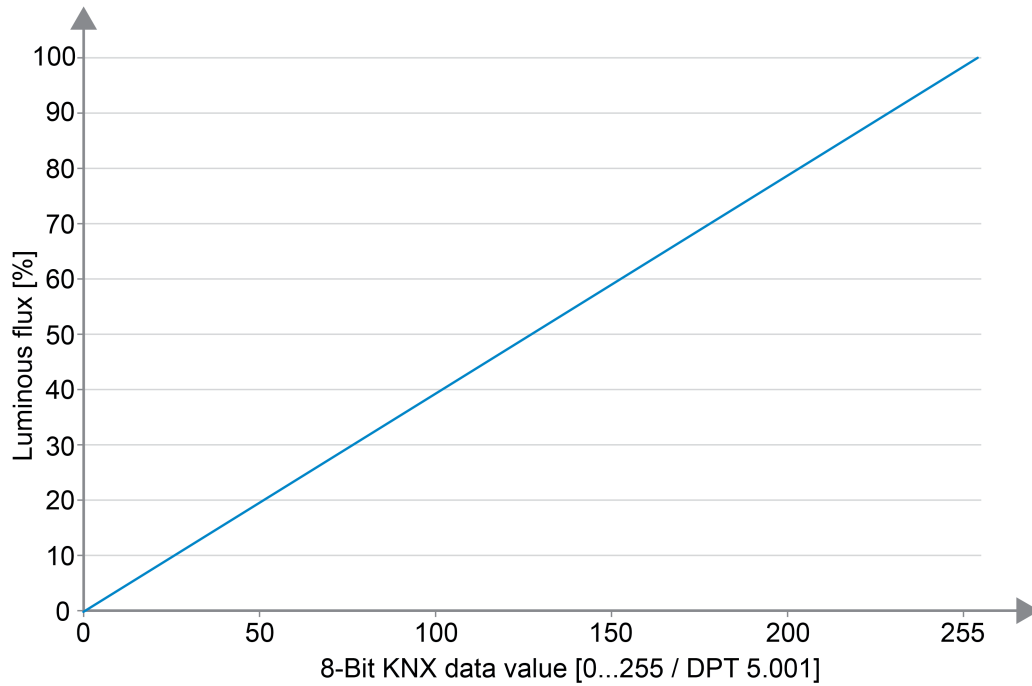

Figure 33: Linear DALI dimming characteristic
(relative luminous flux [%] depending on the 8-bit KNX data value [0...255])

KNX brightness value	KNX brightness value [%]	DALI data value (APL)	Luminous flux [%]
0	0	0	0
1	0.4	27	0.2
10	4	136	4
50	20	194	19
80	32	212	32
100	40	220	40
125	50	228	49
150	60	235	60
175	70	240	68
200	80	245	78
225	90	249	87
255	100	254	100

Transmission of data values with a linear DALI dimming characteristic

i Advantages of a linear DALI dimming characteristic:
 Adjustment to existing KNX actuators possible. KNX dimming actuators or 1-10-V control units normally form brightness values linearly in a physical output signal by the "Scaling" (DPT 5.001 / 0...255 -> 0.4 %...100 %) defined according to the KNX specification. If a DALI system with such KNX actuators is combined in an installation, it is normally necessary to set a linear dimming characteristic in the DALI Gateway in order to adapt the dimming behaviour to the other actuators. Otherwise, the luminaires will dim to a different brightness with identical KNX data values.
 A linear dimming characteristic also has a positive effect on a multichannel RGB colour control, especially during dynamic colour changes (e.g. control of 3 different DALI channels for RGB colour mixing). By converting the KNX data values to a linear luminous flux for each primary colour, colours can be mixed reliably in a wide spectrum by the luminaire. In the case of operating devices that have a high physical minimum brightness (> 3 %) and thus a limited luminous flux range, a linear characteristic allows the possible KNX brightness range (0.4 %...100 %) to be utilised usefully in the lower dimming range by the increased DALI data values.

i Disadvantages of a linear DALI dimming characteristic:
 Dimming operations are not adjusted to the brightness perception of the human eye. This means that the dimming behaviour for mere brightness control is perceived as uneven due to the logarithmic human perception.
 High number of levels in the lower dimming range.

- Logarithmic DALI dimming characteristic:

With this setting, the Gateway forwards KNX brightness values to the DALI page virtually unprocessed. Merely a smoothing of the data values in the lower dimming range takes place. A logarithmic dimming sequence of the relative luminous flux results at the physical output of an operating device through the combination of forwarding the value of the Gateway and the logarithmic characteristic of the operating devices.

Feedbacks of the effective DALI brightness value to the KNX is also possible in this case. Owing to the finely adjustable level in the lower dimming range of a logarithmic DALI characteristic, KNX brightness values of up to approx. 10 % are reported as a brightness value 0.4 %. Predefined KNX brightness values up to approx. 23 % are displayed in the feedback as brightness value 11 % and KNX brightness values up to approx. 33 % are displayed as brightness value 24 %. The feedback occurs constantly from approx. 34 % KNX brightness.

Example of brightness change:

KNX brightness: 50 % -> DALI data value (APL): 128 -> Luminous flux: approx. 3 % -> The human eye subjectively perceives about half of the luminaire brightness.

KNX brightness: 75 % -> DALI data value (APL): 191 -> Luminous flux: approx. 18 % -> The human eye clearly perceives a brightness difference between the previous dimming setting. The dimming operation is constantly effective.

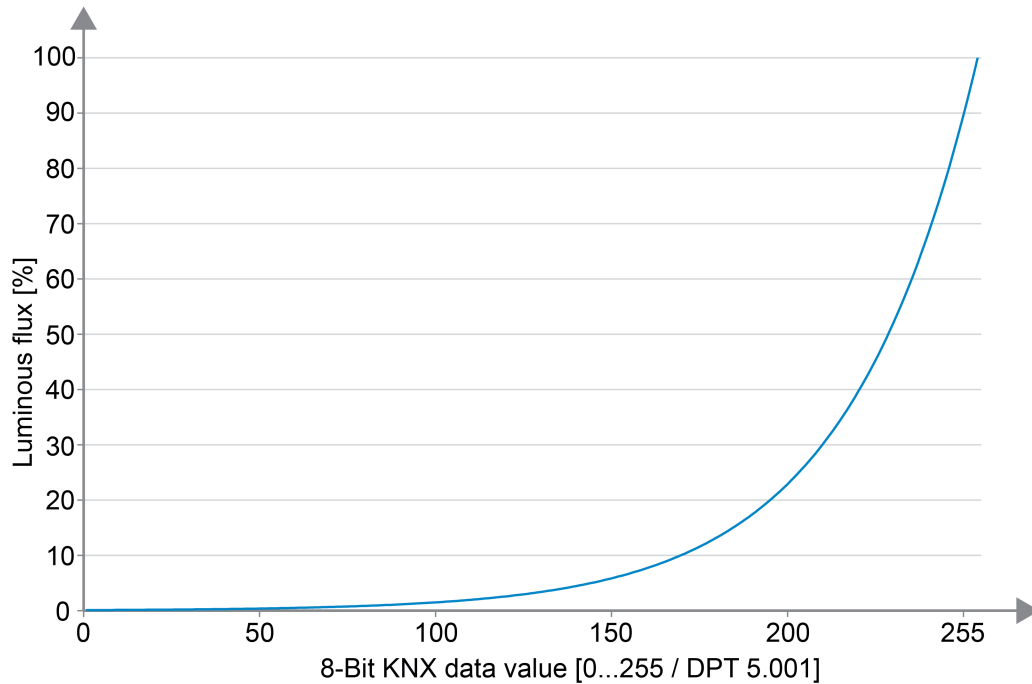

Figure 34: Logarithmic DALI dimming characteristic (relative luminous flux [%] depending on the 8-bit KNX data value [0...255])

KNX brightness value	KNX brightness value [%]	DALI data value (APL)	Luminous flux [%]
0	0	0	0
1	0.4	1	0.1
10	4	1	0.1
50	20	27	0.2
80	32	60	0.5
100	40	100	1.5
125	50	125	3
150	60	150	5.8
175	70	175	12
200	80	200	23
225	90	225	45
255	100	254	100

Transmission of data values with a logarithmic DALI dimming characteristic

- i** Advantages of a logarithmic DALI dimming characteristic:
 Ideal for pure brightness controls. Adjustment to the brightness perception of the human eye. As a result, brightness changes are perceived evenly in the entire dimming range. Fine number of levels in the lower dimming range.

- i Disadvantages of a logarithmic DALI dimming characteristic:
Difficult adjustment up to no adjustment at all on other KNX actuators that only dim linearly.
Poor sliding progression when mixing colours via separate DALI channels.
In the case of operating devices that have a high physical minimum brightness ($> 3\%$) and thus a limited luminous flux range, the lower KNX dimming range (0.4 %...50 %) cannot be utilised.

4.2.4.3.2 Controlling the colour temperature

Settable colour temperature range

When activating DALI operating devices that support the device type "Tunable White" (DT8 - TW), the colour temperature of the connected luminaire can be changed. The settable colour temperature range of a DALI group or single device can be limited by defining a lower and upper colour temperature value. The parameters "Minimum colour temperature" and "Maximum colour temperature" in the parameter node "Addressing -> Groups -> [x] Group name -> Tunable white function" (x = Group number 1...32) or "Addressing -> Single devices -> [x] Device name -> Tunable white function" (x = Short address 1...64) specify the colour temperature values, which may not be undershot or exceeded when the Gateway is in a switched-on operating state. In this way, the colour temperature of the controlled luminaires of the DALI operating devices can be limited individually and adapted to the respective application.

Furthermore, the colour temperature value, which is set whenever switching on via the "Switching" or the "Central function switching" object on the DALI operating devices, can be predefined. The parameter "Colour temperature after switching on" defines this colour temperature value separately for each group and each single device. The settable value is anywhere between the minimum and maximum colour temperature.

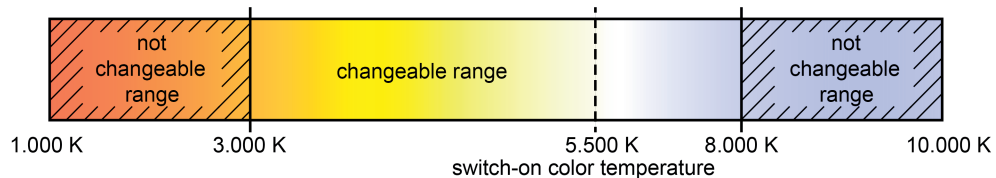

Figure 35: Example of a configured colour temperature range with switch-on colour temperature

- i** DALI lights that can change the colour temperature are generally fitted with two different luminaires for warm white and cold white light. The luminous flux of both luminaires can be varied independently and thus the colour temperature can be changed in the specified range by different activation via the upstream DALI operating device (e.g. DALI DT8 LED driver). In the lower colour temperature range, only the warm white luminaire is usually switched on. In the upper colour temperature range, only the cold white luminaire is switched on. A DALI operating device according to device type 8 essentially changes the proportional luminous flux of the luminaire while maintaining the total luminous flux provided, which is specified via the brightness of the DALI group or single device. During a dimming operation of the colour temperature, it can happen that the operating devices switch the luminaire on or off if required. This can lead to switching operations in the transition ranges, which cause the dimming operations to briefly appear unsteady.

Setting minimum colour temperature

The minimum colour temperature can be set separately for each DALI group and each single device.

- Set the parameter "Minimum colour temperature" in the parameter node "Addressing -> Groups -> [x] Group name -> Tunable white function" or "Addressing -> Single devices -> [x] Device name -> Tunable white function" to the required colour temperature.

The set colour temperature is not undershot in any operating state.

- i** The upper limit of the selection of the value settable here is limited by the configured maximum colour temperature (minimum colour temperature < maximum colour temperature).

- i** During editing of the minimum colour temperature, the ETS plug-in checks all configured colour temperature values of the group or the single device (e.g. switch-on colour temperature, scene values) to determine whether the values undershoot the minimum colour temperature. If this is the case, the plug-in will signal a value conflict and offer the following selection...
 - the colour temperature values can be adjusted to the minimum colour temperature, or
 - the minimum colour temperature setting is reset to its original value.
- i** If values are received by the "Absolute colour temperature" object and are less than the configured minimum colour temperature, then the Gateway will set the minimum colour temperature as the new colour temperature value for the group or single device concerned. In this case, the 1-bit "Invalid colour temperature" feedback can be generated as an option.

Setting the maximum colour temperature

The maximum colour temperature can be set separately for each DALI group and each single device.

- Set the parameter "Maximum colour temperature" in the parameter node "Addressing -> Groups -> [x] Group name -> Tunable white function" or "Addressing -> Single devices -> [x] Device name -> Tunable white function" to the required colour temperature value.

The set brightness is not undershot in any switched-on operating state.
- i** The lower limit of the selection of the value settable here is limited by the configured minimum colour temperature (minimum colour temperature < maximum colour temperature).
- i** During editing of the maximum colour temperature, the ETS plug-in checks all the configured colour temperature values of the group or the single device (e.g. switch-on colour temperature, scene values) to determine whether the values exceed the maximum colour temperature. If this is the case, the plug-in will signal a value conflict and offer the following selection...
 - the colour temperature values can be adjusted to the maximum colour temperature, or
 - the maximum colour temperature setting is reset to its original value.
- i** If values are received by the "Absolute colour temperature" object and are greater than the configured maximum colour temperature, then the Gateway will set the maximum colour temperature as the new colour temperature value for the group or single device concerned. In this case, the 1-bit "Invalid colour temperature" feedback can be generated as an option.

Setting the switch-on colour temperature

The switch-on colour temperature can be set separately for each DALI group and each single device.

- Set the parameter "Colour temperature after switching on" in the parameter node "Addressing -> Groups -> [x] Group name -> Tunable white function" or "Addressing -> Single devices -> [x] Device name -> Tunable white function" to "Set colour temperature value". In the selection box, configure the necessary colour temperature value.

The set colour temperature is set after receipt of an ON telegram via the "Switching" communication object or after receipt of a central telegram with the polarity "activated".
- Set the parameter "Colour temperature after switching on" to "Memory value (colour temperature before switching off last time)".

On switching on, the active and internally saved colour temperature value prior to switching off last time is set (via the "Switching" or "Central function switching" object). This memory value is saved in the volatile memory, which means that after a device reset (mains voltage return or an ETS programming operation), the value is predefined to maximum colour temperature.
- Set the parameter "Colour temperature after switching on" to "tracked colour temperature value".

On switching on, the internally tracked colour temperature most recently specified and in the "OFF" state is preset. The tracked colour temperature value is not influenced by an ETS programming operation or by a bus voltage failure ("no change"). When the bus/mains voltage returns, the colour temperature active most recently before the bus/mains voltage failure is restored. Hence, this colour temperature is taken into account as a colour temperature value to be tracked when switching on.

- i** In the "Set colour temperature value" setting: The lower limit of the selection of the value that can be set here is limited by the configured minimum colour temperature and the upper limit by the configured maximum colour temperature.
- i** A memory value is also then saved internally by a switch-off telegram if the bus-controlled switch-off is overridden, for example, by a disable or forced position function or by a manual operation. In this case, the internally tracked colour temperature value is saved as memory value.
- i** The colour temperature to be set by switching on is either dimmed in the configured dimming time or is jumped to directly depending on the configured dimming behaviour (absolute dimming). The dimming characteristic for colour temperature changes is always linear.
- i** A switched-off DALI group or single device can also be switched on by the receipt of an absolute colour temperature value or by relative dimming (configurable functions) if necessary. In this case, the switch-on colour temperature is not evaluated. The Gateway then activates on switching on the colour temperature, which was set directly by the absolute colour temperature value or by the relative dimming operation.

Dimming characteristic and dimming speeds

When activating DALI operating devices that support the device type "Tunable White" (DT8 - TW), the colour temperature can be changed by a relative or absolute dimming operation. The limits of the colour temperature range adjustable by a dimming operation is defined by the minimum and maximum colour temperature predefined in the ETS.

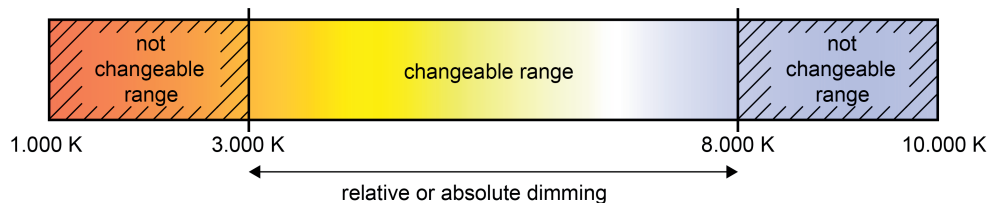

Figure 36: Example of a dimmable colour temperature range

A DALI group or single device can be dimmed by...

- **Relative dimming:**
Relative dimming of the colour temperature can be triggered by the 4-bit "Relative colour temperature" communication object available for each group or single device. The data format of the "dimming" object - as well as with relative dimming of the brightness - complies with the KNX standard DPT 3.007, which means that the dimming direction and relative dimming increments can be predefined in the dimming telegram or dimming procedures can also be stopped. A relative dimming operation allows a colour temperature value to be changed constantly and always starts from the colour temperature that is set at the time of the dimming command.
In the plug-in of the DALI Gateway, the dimming speed for relative dimming of the colour temperature can be configured separately for each group and each single device and independent of the dimming speed for a brightness change.
A relative dimming telegram for controlling the colour temperature can also switch on a group or single device in the "OFF" state. In some applications, it may be necessary, however, for a switched off group or switched off device to still remain off until a relative dimming telegram of the colour temperature is received. This is interesting when using light scenes, for instance: Several DALI groups are set to a defined colour temperature via a light scene. Other groups are switched off by the scene. Only the colour temperature of channels not switched off by the scene recall should be changed by dimming up afterwards. Here, it is necessary for groups or single devices not to respond to a relative dimming operation of the colour temperature and thus not to switch on. The parameter "Behaviour when OFF by relative dimming of the colour temperature" defines whether or not a DALI group or single device in the "OFF" state switches on via a relative dimming telegram of the colour temperature or remains switched off and only tracks the dimming operation internally.

- **Absolute dimming:**
Absolute dimming is triggered by specifying a colour temperature value. This value can be predefined by the 2-byte "Absolute colour temperature (K)" communication object according to KNX DPT 7.600 of the KNX, which is available separately in each group or single device. In addition, colour temperature values can also be set by the scene function or by the effect function.
When predefining a colour temperature value via the object, by a scene recall or by an effect step, it is possible to configure (separately for each) in the ETS plug-in whether the value is jumped to directly or alternatively whether it is dimmed to using a dimming time (Fading Time).
Just as with relative dimming, an absolute dimming telegram for controlling the colour temperature can also switch on a group or single device in the "OFF" state. Here too, it may be necessary in some applications for a switched off group or switched off device to still remain off if a new colour temperature value is specified absolutely. The parameter "Behaviour when OFF by absolute dimming of the colour temperature" defines whether or not a DALI group or single device in the "OFF" state switches on via a new absolute 2-byte dimming telegram of the colour temperature or remains switched off and only tracks the colour value internally.

On the DALI Gateway, it is possible that the setting of a dimming time for relative dimming or absolute dimming (with dimming of the colour temperature values) can take place for the DALI Gateway in the range minimum colour temperature to maximum colour temperature. The dimming step times can be derived from the configured times.

- i** The dimming characteristic for colour temperature changes is always linear.
- i** It is possible via the 1-bit "Absolute colour temperature (K)" feedback object to optionally display whether a colour temperature specified externally via the "Absolute colour temperature (K)" is valid. This is the case, if the specified colour temperature violates the set limits of the minimum and maximum colour temperature.
- i** Relative dimming of the colour temperature cannot be triggered by manual operation directly on the device.

- i** Even if colour temperature values are instantly jumped to, the dimming procedure on DALI operating devices always takes a very short time. This dimming procedure is dependent on the system. The colour temperature value jumped to will be dimmed to within 0.7 seconds (short fading). This time cannot be altered.

It is optionally possible to automatically change the colour temperature proportionally when dimming the brightness. This makes it possible with little project planning to simulate a thermal radiator using almost any colour temperature controllable luminaire (perception of the light source such as an incandescent or halogen lamp). Example:

A DALI luminaire is fitted with colour temperature controllable LED lights. The lamp is switched via KNX telegrams and dimmed in brightness. When dimming, the colour temperature should adjust automatically to the brightness of the dimming setting without the colour temperature being set separately via the KNX. At low brightness, the luminaire should glow warm white, and at high brightness it should glow cold white. Thus, the colour temperature should change constantly in the same way as the brightness in the ranges of the dimmable brightness range.

The maximum possible KNX brightness range (0 %...100 %) is mapped proportionally to the configured colour temperature range during the automatic adjustment of the colour temperature (minimum colour temperature [0 %]...maximum colour temperature [100 %]). A configured minimum and maximum brightness limits the automatically adjustable colour temperature range. In the same way, a configured minimum colour temperature can never be undershot and a maximum colour temperature can never be exceeded even if the brightness range allows a greater adjustment range.

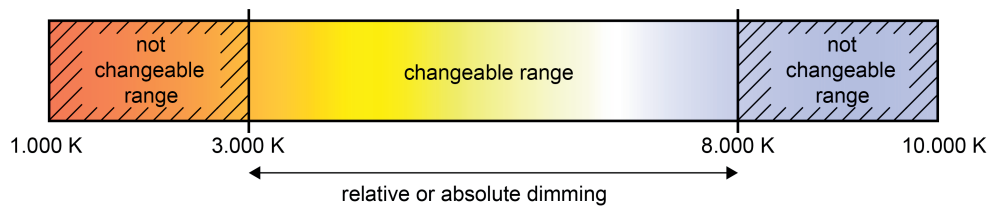

Figure 37: Automatic adjustment of the colour temperature to the set brightness
Example in the maximum brightness and colour temperature range

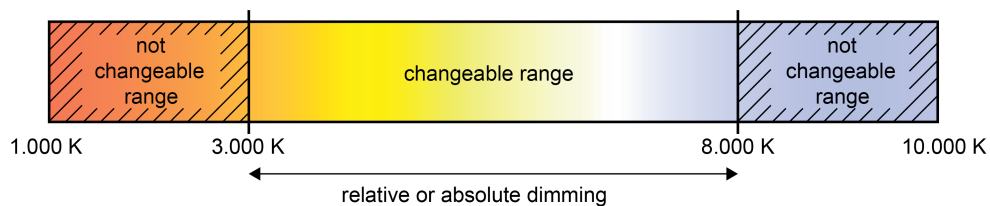

Figure 38: Automatic adjustment of the colour temperature to the set brightness
Example with limited brightness and colour temperature range

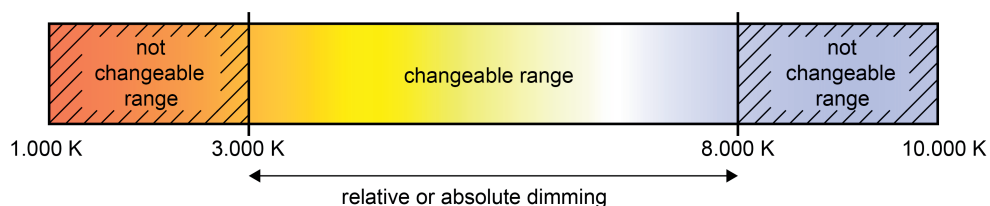

Figure 39: Automatic adjustment of the colour temperature to the set brightness
Example with limited colour temperature range

The automatic adjustment of the colour temperature to the brightness dimming setting if a DALI group or single device can take place during relative dimming and absolute dimming. The parameters "Behaviour of the colour temperature during relative dimming of the brightness" and "Behaviour of the colour temperature during absolute dimming of the brightness" allow the described function for the relative or absolute dimming to be activated separately.

- i** The brightness of the connected luminaire activated on the physical output of the DALI operating device is dimmed via the configured DALI characteristic (linearly or logarithmically) in the ETS for each DALI group or single device. The colour temperature is constantly dimmed linearly.

Setting dimming time for relative dimming

In the plug-in of the DALI Gateway, the dimming time for relative dimming of the colour temperature can be set separately for each group and each single device.

- Set the parameter "Time for relative dimming for colour temperature adjustment" in the parameter node "Addressing -> Groups ... - [x] Group -> TW function colour temperature 1" or "Addressing -> Single devices ... - [x] Electronic ballast -> Set TW function colour temperature 1" to the required dimming time.

Setting dimming behaviour for absolute dimming

In the plug-in of the DALI Gateway, the dimming behaviour for absolute dimming can be set separately for each group and each single device using the "Absolute colour temperature (K)" object.

- Set the parameter "Dimming behaviour on receipt of a colour temperature" in the parameter node "Addressing -> Groups ... - [x] Group -> TW function colour temperature 1" or "Addressing -> Single devices ... - [x] Electronic ballast -> Set TW function colour temperature 1" to "dim".

Once a new colour temperature value is received, it is set by means of the calculated dimming increment time for absolute dimming.

- Set the parameter "Dimming behaviour after receipt of a colour temperature" to "jump to". As soon as a new colour temperature value is received it will be instantly jumped to.

- i** During a scene or effect recall, the dimming behaviour can be configured separately.

Setting dimming time for absolute dimming

In the plug-in of the DALI Gateway, the dimming time for absolute dimming can be set separately for each group and each single device using the "Absolute colour temperature (K)" object.

The dimming behaviour must be configured as "Dim to".

- Set the parameter "Time for absolute dimming for colour temperature adjustment" in the parameter node "Addressing -> Groups ... - [x] Group -> TW function colour temperature 1" or "Addressing -> Single devices ... - [x] Electronic ballast -> Set TW function colour temperature 1" to the required dimming time.

- i** On the DALI Gateway, it is possible that the setting of a dimming time for relative dimming or absolute dimming (with dimming of the colour temperature values) can take place for the DALI Gateway in the range minimum colour temperature to maximum colour temperature. The dimming step times can be derived from the configured times.

Setting dimming behaviour in OFF state for relative dimming

A relative dimming telegram for controlling the colour temperature can also switch on a group or single device in the "OFF" state. In the plug-in of the DALI Gateway, the behaviour in the "OFF" state when receiving a relative dimming telegram can be set separately for each group and each single device by the parameter "Behaviour when OFF by relative dimming of the colour temperature".

- Set the parameter to "Colour temp. value change switches ON (standard)".

The DALI group or the single device in the "OFF" state is switched to the switch-on brightness by a relative dimming telegram of the colour temperature telegram. The dimming operation for the colour temperature starts at the colour temperature value most recently set by the Gateway or which was tracked in the "OFF" state. The relative dimming telegram that leads to switching on, specifies the dimming direction and dimming increment. The dimming operation stops after reaching the specified colour temperature.
- i** After an ETS programming operation, the colour temperature value, at which the dimming operation is started for relative dimming after the "OFF" state, is permanently set to the mean value of the configured colour temperature range: $\text{colour temperature}_{\text{start dim}} = ((\text{colour temperature}_{\text{max}} - \text{colour temperature}_{\text{min}}) : 2) + \text{colour temperature}_{\text{min}}$.
- Set the parameter to "Colour temp. value change is ignored".

The DALI group or the single device in the "OFF" state is not switched on by the relative dimming telegram. The group or single device remains switched off and only tracks the dimming operation internally based on the last valid colour temperature currently set.

Setting dimming behaviour in OFF state for absolute dimming

An absolute 2-byte colour temperature telegram can also switch on a group or single device in the "OFF" state. In the plug-in of the DALI Gateway, the behaviour in the "OFF" state when receiving an absolute colour temperature telegram can be set separately for each group and each single device by the parameter "Behaviour when OFF by absolute dimming of the colour temperature".

- Set the parameter to "Colour temp. value change switches ON (standard)".

The DALI group or the single device in the "OFF" state is switched to switch-on brightness by an absolute colour temperature telegram. If the dimming behaviour of the absolute colour temperature is configured to "jump to", the intended colour temperature value is preset. If the dimming behaviour is configured to "dim to", the dimming operation starts at the colour temperature value most recently set by the Gateway or which was tracked in the "OFF" state. The dimming operation is executed according to the set dimming time. The dimming operation stops after reaching the specified colour temperature.
- Set the parameter to "Colour temp. value change is ignored".

The DALI group or the single device in the "OFF" state is not switched by the absolute colour temperature telegram. The group or the single device remains switched off and only tracks the colour temperature value internally.

Setting the behaviour of the colour temperature during dimming of the brightness

It is optionally possible to automatically change the colour temperature proportionally when dimming the brightness. This makes it possible with little project planning to simulate a thermal radiator using almost any colour temperature controllable luminaire (perception of the light source such as an incandescent or halogen lamp). In the plug-in of the DALI Gateway, the behaviour of the colour temperature can be set separately by means of parameters for each group and each single device for this application during dimming of the brightness separately for the relative or absolute dimming.

- Set the "Behaviour of the colour temperature during relative dimming of the brightness" to "no change of colour temperature".
The relative dimming of the brightness via a 4-bit dimming telegram has no effect on the colour temperature of the group or single device. The colour temperature can only be controlled separately.
- Set the "Behaviour of the colour temperature during relative dimming of the brightness" to "Colour temperature proportional to brightness".
During relative dimming of the brightness via a 4-bit dimming telegram, the colour temperature of the group or single device is also changed proportionally. The colour temperature becomes warmer when dimming down. The colour temperature becomes colder when dimming up.
The colour temperature can also be controlled separately.
- Set the parameter "Behaviour of the colour temperature during absolute dimming of the brightness" to "no change of colour temperature".
The absolute dimming of the brightness via a 1-byte brightness value has no effect on the colour temperature of the group or single device. The colour temperature can only be controlled separately.
- Set the parameter "Behaviour of the colour temperature during absolute dimming of the brightness" to "Colour temperature proportional to brightness".
During absolute dimming of the brightness via a 1-byte brightness value, the colour temperature of the group or single device is also changed proportionally. The colour temperature becomes warmer when dimming down. The colour temperature becomes colder when dimming up.
The colour temperature can also be controlled separately.

4.2.4.3.3 Response after a device reset

The switching states or brightness values that set themselves after a bus voltage failure, bus or mains voltage return or after an ETS programming operation for DALI groups or single devices can be configured in the ETS. The behaviour of the colour temperature of a group or single device is unalterably predefined in the case of a device reset.

The configuration options and permanently defined functions are described below.

Presetting the behaviour of the brightness after an ETS programming operation

The parameter "Behaviour after ETS programming operation" is available separately for each group or each single device in the parameter node "Addressing -> Groups ... -> [x] Group" or "Addressing -> Single devices ... -> [x] Electronic ballast". This parameter can be used to configure the brightness behaviour, irrespective of the behaviour after a bus or mains voltage return.

- Set the parameter to "No change".

After an ETS programming operation, the DALI Gateway does not transmit any commands to the DALI operating devices. The assigned DALI operating devices show no response and remain in the brightness state that was last set.

- i** In this state, no colour temperature control is possible after an ETS programming operation even if the devices are still switched on due to the last brightness state. In this case, the group or single device concerned must either be switched off and switched on again after the ETS programming operation or must be preset to a brightness value unequal "0 %" by a new telegram. Only in this way the Gateway evaluates the state "ON" for the operating devices and permits a control of the colour temperature by new commands.

- Set the parameter to "switch off".

The DALI operating devices are switched off by the ETS after a programming operation.

- Set the parameter to "Brightness value". In the selection box, configure the necessary brightness value.

The DALI operating devices are set to the predefined brightness value in the selection box next to the parameter. The selection of the settable value is limited by the configured minimum and maximum brightness.

- i** The configured behaviour will be executed after every application or parameter download by the ETS. A simple download of the physical address alone or partial programming of only the group addresses has the effect that this parameter is disregarded and that the configured "Behaviour after bus voltage return" will be executed instead.

- i** An ETS programming operation can only be executed if the mains voltage supply of the DALI Gateway is switched on.

- i** In the "No change" setting: The communication objects of the Gateway are initialised with "0" after a programming operation. In this case, the switching status or brightness value feedback only corresponds to the 'true' brightness state when the group or the single device have been controlled at least once via the KNX or by manual operation. In this setting, feedback objects set as actively transmitting do not transmit a telegram.

- i** An active manual mode will be terminated by an ETS programming operation.

- i** After an ETS programming operation, the disabling functions and the forced-positions are always deactivated.

- i** After an ETS programming operation, the DALI Gateway initialises itself and configures the connected operating devices with relevant data via the DALI cable (e.g. minimum brightness, maximum brightness, power-on level, system failure level). For this reason, the entire DALI system should ideally be connected and completely ready for operation so that all operating devices apply configuration changes. After each DALI commissioning with changes (fully or partially), the application program must be reloaded into the Gateway using the ETS. When doing so, it must be ensured that at least the newly added operating devices or devices, in which the configuration was changed in the ETS, are ready for operation after the ETS programming operation during the commissioning. If there is an error on the DALI cable (e.g. short-circuit, cable break) during the initialisation of the operating devices, then the DALI configuration cannot be executed. The error must then be eliminated and ETS programming restarted. During the configuration operation after an ETS programming operation, "- -" is displayed in the 7-segment display on the front panel of the device.
- i** If KNX telegrams for groups or single devices are received during Gateway initialisation, then the device will perform the most recently specified command and not the configured behaviour after an ETS programming operation.

Setting the behaviour of the brightness in case of bus voltage failure

The parameter "Behaviour on bus voltage failure" is available separately for each group or each single device in the parameter node "Addressing -> Groups ... -> [x] Group" or "Addressing -> Single devices ... -> [x] Electronic ballast".

- Set the parameter to "No change".

In the case of a bus voltage failure, the DALI Gateway does not transmit any commands to the DALI operating devices. The assigned DALI operating devices show no response and remain in the brightness state that was last set.

- Set the parameter to "switch off".

The DALI operating devices are switched off via the DALI cable in the case of a bus voltage failure if the mains voltage supply of the Gateway is still switched on.

- Set the parameter to "Brightness value". In the selection box, configure the necessary brightness value.

The DALI operating devices are set to the predefined brightness value via the DALI cable in the selection box next to the parameter. The selection of the settable value is limited by the configured minimum and maximum brightness.

- i** If there is a voltage failure on the DALI cable (e.g. due to short-circuit, cable break, mains voltage failure on DALI Gateway), then the assigned DALI operating devices will also show the configured behaviour when the bus voltage fails. This is guaranteed because the parameter setting in the DALI operating devices is applied as the "System Failure Level" for the brightness after an ETS programming operation.
Exception: Optionally, the system failure level, regardless of the behaviour in case of bus voltage return, can be set on centrally supplied emergency lights to a separate brightness value for emergency operation. In these cases, it is not the configuration for the "Behaviour on bus voltage failure" which is applied as the System Failure Level, but the brightness defined for emergency operation.
- i** In the event of a bus failure or mains voltage failure, the current states of the forced positions are also saved so that they can be tracked in the event of bus or mains voltage return if necessary (depending on the configuration of the forced positions).
- i** Active disabling functions or forced position functions are always cancelled by a bus voltage failure and are subsequently inactive in the connection.

Setting the behaviour of the brightness after bus voltage return

The parameter "Behaviour after bus voltage return" is available separately for each group or each single device in the parameter node "Addressing -> Groups ... -> [x] Group" or "Addressing -> Single devices ... -> [x] Electronic ballast". The parameter also defines the behaviour of the DALI Gateway after mains voltage return.

- Set the parameter to "No change".
After bus or mains voltage return, the DALI Gateway does not transmit any commands to the DALI operating devices. The assigned DALI operating devices show no response and remain in the brightness state that was last set (also see the note on "Power-On Level" further below).
- ⓘ In this state, no colour temperature control is possible after bus or mains voltage return even if the devices are still switched on due to the last brightness state. In this case, the group or single device concerned must either be switched off and switched on again after bus or mains voltage return or must be preset to a brightness value unequal "0 %" by a new telegram. Only in this way the Gateway evaluates the state "ON" for the operating devices and permits a control of the colour temperature by new commands.
- Set the parameter to "switch off".
The DALI operating devices are switched off on bus/mains voltage return via the DALI cable.
- Set parameter to "brightness value before bus voltage failure".
After bus or mains voltage return, the brightness value set most recently before the bus or mains voltage failure and saved internally on bus/mains voltage failure will be tracked.
- Set the parameter to "Brightness value". In the selection box, configure the necessary brightness value.
The DALI operating devices are set to the predefined brightness value in the selection box next to the parameter. The selection of the settable value is limited by the configured minimum and maximum brightness.
- Set the parameter to "Start staircase function".
The staircase function is – irrespective of the 'Switching' object - activated after bus or mains voltage return.
- ⓘ After mains voltage return, the DALI Gateway initialises the configured operating devices briefly. During initialisation, "- -" is displayed in the 7-segment display on the front panel of the device.
- ⓘ The "Start staircase function" setting is only available when the staircase function is enabled for the affected group or the affected single device. If this setting was selected and the staircase function was deactivated later, the parameter "Behaviour after bus voltage return" automatically sets itself to the "No change" setting.
- ⓘ Setting "Brightness value as before bus/mains voltage failure": An ETS programming operation of the application or the parameter resets the internally stored switching state to "OFF".
- ⓘ In the "No change" setting: The communication objects of the Gateway are initialised with "0" after bus/mains voltage return. In this case, the switching status or brightness value feedback only corresponds to the 'true' brightness state when the group or the single device have been controlled at least once via the KNX or by manual operation. In this setting, feedback objects set as actively transmitting do not transmit a telegram.

- i** If mains voltage only on the connected DALI operating devices (e.g. supply from an external mains conductor) is switched on or the Gateway is also switched on again and the response is configured to "no change", the operating devices set themselves to the brightness specified in their "Power-On level". After an ETS programming operation, this value is programmed into the operating devices by the DALI Gateway and corresponds to the setting of the parameter "Behaviour after bus voltage return". In the settings "Brightness value before bus voltage failure" and "Start staircase function", the command "No change" is programmed into the operating devices as the power-on-level. In the case of all other settings, the configured commands are applied directly in the operating devices. If the mains voltage of the DALI Gateway is switched on, the device only executes the parameter "Behaviour after bus voltage return" after initialisation. It may occur that the DALI operating devices react more quickly after bus voltage return and set themselves to the power-on level before the Gateway can transmit individual commands on the DALI cable. This may result in short brightness jumps. If KNX telegrams for groups or single devices are received during Gateway initialisation, the device will perform the most recently specified command and not the configured behaviour after bus voltage return.
- i** When using standby switch-off and the delay until start-up of the DALI devices, ensure that the parameter "Behaviour after bus voltage return" is configured as "Switch off". This means that the affected devices do not switch-on directly when the mains voltage returns but only after they have received an appropriate DALI command from the Gateway via the DALI cable.
- i** In the case of forced position as supplementary function: The communication object of the forced position can be initialised separately after bus voltage return. This has an effect on the reaction of the group or the single device when the forced position is activated. The configured "Behaviour on bus voltage return" is only executed when no forced position after a bus voltage return is activated.
- i** With disabling function as supplementary function: Active disabling functions are always inactive after bus or mains voltage return.
- i** Manual control is possible only while the actuator is supplied with power from the mains. Manual operation ends in case of bus voltage failure, bus voltage return or mains voltage failure. Manual operation in broadcast mode (unprogrammed DALI Gateway) cannot be terminated by a bus voltage failure/bus voltage return.

Presetting the behaviour of the colour temperature after an ETS programming operation

The behaviour of the colour temperature after an ETS programming operation is permanently set to "no change". After an ETS programming operation, the DALI Gateway does not transmit any colour temperatures to the DALI operating devices. This means that the assigned DALI operating devices remain in the colour temperature most recently specified.

- i** The Gateway only transmits new colour temperatures in the state "ON" to the operating devices. Consequently, after an ETS programming operation a new colour temperature is only then preset in the operating devices via the colour temperature predefined via the KNX after the group or single device was switched on to a brightness value unequal "0 %" (see "Presetting the behaviour of the brightness after an ETS programming operation").
- i** The communication objects of the Gateway are initialised with "0" after a programming operation. In this case, the feedback of the colour temperature only then corresponds to a valid value when the colour temperature of the group or single device was controlled at least once via the KNX and the transmission criterion of the feedback was met. Actively transmitting feedback objects of the colour temperature automatically do not transmit any telegram immediately after an ETS programming operation.
- i** The predefined behaviour is executed by the ETS after every application or parameter download. The simple download of the physical address alone or partial programming of only the group addresses has the effect that the setting "no change" is disregarded and that the specified "Behaviour of the colour temperature after bus voltage return" will be executed instead.

- i** If KNX telegrams for groups or single devices are received for controlling the colour temperature after an ETS programming operation during the initialisation of the Gateway (display "- -" in the 7-segment display on the front panel of the device), the device will perform the most recently specified command.
- i** DALI operating devices normally only store the most recently specified colour temperature in the volatile memory. This means that the most recently transmitted colour temperature information will be lost due to a failure of the mains voltage on the operating devices. After mains voltage return, operating devices normally set themselves to minimum or maximum colour temperature provided that the brightness of the group or single device was predefined greater than "0 %" (power-on level).
The behaviour on the operating devices with regard to the colour temperature after mains voltage return is defined immediately by the operating devices and cannot be influenced or signalled back by the Gateway. The Gateway can only influence the colour temperature after mains voltage return if the mains voltage was also switched off and switched on again on the Gateway (see "Behaviour of the colour temperature after bus voltage return").

Setting the behaviour of the colour temperature in case of bus voltage failure

The behaviour of the colour temperature in case of bus voltage failure, just like the behaviour after an ETS programming operation, is permanently preset to "no change". In the case of a bus voltage failure, the DALI Gateway does not transmit any colour temperature commands to the DALI operating devices. The assigned DALI operating devices remain at the colour temperature most recently set provided that the mains voltage supply of the operating devices is still guaranteed. After bus voltage failure, it is no longer possible to control the colour temperature.

- i** DALI operating devices that support the device type "Tunable White" (DT8 - TW) are able to store a specific value during the commissioning, which defines the effective colour change for the failure of the DALI operating voltage for selectively influencing the colour temperature control. The Gateway always initialises this DALI parameter in the operating devices during the configuration of the "System Failure Level" for the brightness with the command "no change" (value "255" / "MASK"), so that a failure of the DALI operating voltage (e.g. due to a failure of the mains voltage supply on the DALI Gateway) does not cause a change in the colour temperature value most recently specified.
This property must be taken into account, for example, in DALI centrally supplied emergency lighting systems if the DALI Gateway is not integrated into the emergency power supply and the operating devices respond autonomously to the mains voltage failure (failure of the DALI voltage).

Setting the behaviour of the colour temperature after bus voltage return

The behaviour of the colour temperature after bus or mains voltage return is preset permanently to "Colour temperature before bus voltage failure". After bus or mains voltage return, the colour temperature set most recently before the bus/mains voltage failure by relative or absolute dimming and saved internally on bus/mains voltage failure will be tracked.

- i** The Gateway only transmits the tracked colour temperature in the state "ON" to the operating devices. Consequently, after bus or mains voltage return a tracked or new colour temperature is only then preset in the operating devices via the colour temperature predefined via the KNX after the group or single device was switched on to a brightness value unequal "0 %".

- i** An ETS programming operation of the application or the parameter resets the internally stored colour temperature (0 K). This means that the operating devices concerned normally set themselves to minimum or maximum colour temperature as soon as the group or single device is switched on after bus or mains voltage return (e.g. by the configured behaviour of the brightness after bus voltage return). In this case, the behaviour of the operating devices with regard to the colour temperature is defined immediately by the operating devices and cannot be influenced by the Gateway.
The colour temperature is only then valid after an ETS programming operation as soon as a colour temperature value is newly specified as a result of relative or absolute dimming. The colour temperature only becomes invalid after an ETS programming operation by recalling a scene or an effect with a defined colour temperature value.
- i** The communication objects of the Gateway are initialised with "0" after bus/mains voltage return. After bus voltage return, actively transmitting feedback objects transmit a telegram corresponding to the most recently effective colour temperature in the DALI Gateway, but only if the DALI group or single device is also switched on after mains voltage return (brightness unequal "0 %"). After a mains voltage return, only telegrams corresponding to the effective colour temperature in the DALI Gateway are transmitted when the DALI group or single device is actively on after mains voltage return (brightness unequal "0 %").

4.2.4.3.4 Supplementary function

Supplementary function

Supplementary functions can be enabled for each DALI group and each single device. As a supplementary function, a disabling or alternatively a forced position function can be configured. In this respect, only one of these functions can be enabled for each group or single device. The supplementary functions are enabled and configured in the parameter node "Groups - [x] Group name" (x = Group number 1...32) or "Addressing -> Single device -> [x] Device name" (x = Short address 1...64).

Setting disabling function as supplementary function

During an active disabling function, the KNX operation of the groups or single devices is overridden and locked. Continuous light switching, for example, can also be overridden.

- In the parameter node "Addressing -> Groups ... -> [x] Group" or "Addressing -> Single devices ... -> [x] Electronic ballast", set the parameter "Type of supplementary functions" to "Disabling function".

The disabling function is enabled. The communication object "Disabling function" and the parameters of the disabling function become visible.

- Set the parameter "Polarity disabling object" to the desired polarity.
- Set the parameter "Behaviour at the beginning of the disabling function" to the required behaviour.

At the beginning of the disabling function, the configured behaviour will be executed and the bus control of the group or single device locked. In the "No change" setting, the operating devices of the disabled group or the single device do not show any reaction. The devices remain in the most recently set brightness state.

In the "Flashing" setting, the affected devices are switched on and off cyclically during disabling. The "Flashing time" is generally configured in the parameter node "General". During flashing, the logical switching state is fed back as "Switched on 1" and the brightness value as "Switch-on brightness". A soft ON/OFF function is not executed during flashing. In the "Memory value" setting, the active and internally saved brightness value prior to switching off last time is set (via the "Switching" or "Central function switching" object). This memory value is saved in the volatile memory, which means that after a bus/mains voltage return or an ETS programming operation, the value is predefined to maximum brightness.

- In the parameter node "Addressing -> Groups ... - [x] Group name" or "Addressing -> Single devices ... - [x] Device name", set the parameter "Behaviour at the end of the disabling function" to the required behaviour.

At the end of the disabling function, the configured behaviour will be executed and the bus control of the group or the single device enabled again. In the "No change" setting, the operating devices of the disabled group or the single device do not show any reaction. The devices remain in the state most recently set by the disabling function.

In "tracked brightness value", the set state received during the disabling function or adjusted before the disabling function can be tracked at the end of the disabling with the appropriate brightness value. Any time functions still in progress will also be taken into account if necessary.

In the "flashing" setting, the affected devices are switched on and off cyclically after the disabling. The flashing time is generally configured in the parameter node "General". During flashing, the logical switching state is fed back as "Switched on 1" and the brightness value as "Switch-on brightness". A soft ON/OFF function is not executed during flashing. The flashing status remains active until another bus command is received or manual operation specifies another brightness value. In the "Memory value" setting, the active and internally saved brightness value prior to switching off last time is set (via the "Switching" or "Central function switching" object). This memory value is saved in the volatile memory, which means that after a bus/mains voltage return or an ETS programming operation, the value is predefined to maximum brightness.

- i** After a bus failure or mains voltage failure or programming the application or the parameters with the ETS, the disabling function is always deactivated (object value "0"). With the inverted setting ("1 = enabled / 0 = disabled"), a telegram update "0" must first be carried out after the initialisation until the disabling is activated.
- i** Updates of the disabling object from "activated" to "deactivated" do not produce any reaction on the DALI operating devices.
- i** A group or single device that has been disabled via KNX can still be operated in manual operation thereafter! At the end of a manual operation, the Gateway executes the disabling reaction for the affected groups or devices once again if disabling is still activated at this time.
- i** In the setting "Tracked brightness value": During a disabling function, the overridden functions of the DALI Gateway (switching, dimming, brightness value) continue to be executed internally. Consequently, newly received bus telegrams are evaluated and time functions are triggered as well. At the end of the disabling, the tracked states are set. A scene or effect recall (low polarity) is not tracked.

Setting forced position function as supplementary function

The forced position function can also be combined with other functions of a group or single device. With an active forced position, the upstream functions are overridden so that the affected group or device is locked. The forced position function possesses a separate 2-bit communication object. The first bit (bit 0) of the object "Forced position" indicates whether switch-off or switch-on is forced. If the dimming channel is switched on by force, an ETS parameter defines which brightness value it should be switched on to. The second bit (bit 1) of the object activates or deactivates the forced position (figure 40). The behaviour at the end of the forced position function can be configured. In addition, the forced object can be initialised on bus or mains voltage return.

Bit 1	Bit 0	Function
0	X	Forced position not active -> normal control
0	X	Forced position not active -> normal control
1	0	Forced position active: switch off
1	1	Forced position active: switch on to predefined brightness value

Figure 40: Bit coding of forced position

- In the parameter node "Addressing -> Groups ... -> [x] Group" or "Addressing -> Single devices ... -> [x] Electronic ballast", set the parameter "Type of supplementary functions" to "Forced position function".

The forced position function is enabled. The communication object "forced position" and the parameter of the forced position function become visible.
- Configure the parameter "Brightness for forced position active, ON" to the required behaviour that should be executed if a forced control is activated via the communication object.

In the "Brightness value" setting, the DALI operating devices set the brightness set in the selection box during a forced position. The selectable value is restricted to the limits of the configured minimum and maximum brightness. In the "No change" setting, bus operation is locked but the operating devices show no response and remain in the most recently set brightness state.

In the "Memory value" setting, the active and internally saved brightness value prior to switching off last time is set (via the "Switching" or "Central function switching" object). This memory value is saved in the volatile memory, which means that after a bus/mains voltage return or an ETS programming operation, the value is predefined to maximum brightness.
- Set the parameter "Behaviour at the end of the forced position" to the required behaviour.

At the end of the forced position, the configured behaviour will be executed. Bus operation is enabled again. In the "No change" setting, the operating devices show no response and remain in the brightness state last selected by the forced position. In "tracked brightness value", the state received during the forced position function or the brightness value adjusted before the function can be tracked at the end of the forced position. Any time functions still in progress will also be taken into account if necessary.

- i Updates of the forced position object from "forced position active" to "forced position active" while maintaining the switching status or from "forced position inactive" to "forced position inactive" show no reaction.
- i A group or single device that has been disabled via KNX can still be operated in manual operation thereafter! At the end of a manual operation, the Gateway executes the forced reaction for the affected groups or devices once again if the forced position is still activated at this time.
- i In the setting "tracked brightness value" at the end of the forced position: During a forced position, the overridden functions of the DALI Gateway (switching, dimming, brightness value) continue to be executed internally. Consequently, newly received bus telegrams are evaluated and time functions are triggered as well. At the forced end, the tracked states are set. A scene or effect recall (low polarity) is not tracked.
- i The current state of the object of the forced position function will be stored in case of bus or mains voltage failure.
 - Set the parameter "behaviour after bus voltage return" to the required behaviour.

After bus or mains voltage return, the configured state is transferred to the "Forced position" communication object. When a forced position is activated, the DALI group or the single device is immediately activated and interlocked accordingly by forced control after bus/mains voltage return until a forced control takes place via the bus. In this case, the parameter "Behaviour after bus voltage return" will not be evaluated.

In the "State before bus voltage failure" setting, after bus or mains voltage return, the last existing and internally forced position state that was stored before the bus or mains voltage failure will be tracked. An ETS programming operation deletes the stored state (reaction in that case same as with "no forced position active"). If the tracked state corresponds to "No forced position active", the force-independent parameter "Behaviour after bus voltage return" will be executed on return of bus voltage. If forced position is activated, the DALI operating devices are switched on to the brightness value predefined by the parameter "Switch-on brightness for forced position, ON".
- i After programming the application or parameters with the ETS, the forced position function is always deactivated (object value "0").

4.2.4.3.5 Feedback functions

Feedback for switching status and brightness value

The DALI Gateway can track the current switching state and brightness value of a DALI group or single device via separate feedback objects and can also transmit them to the bus, if the bus voltage is on. The following feedback objects can be enabled independently of each other for each DALI group and each configured single device ...

- Feedback switching status (1-bit),
- Feedback brightness value (1-byte).

The Gateway calculates the object value of the feedback objects during each switching or dimming operation. The Gateway tracks the switching state or brightness value and updates the feedback objects, even when a group or single device is activated by the manual operation or scene function or by using effects.

The switching status feedback object is updated after the following events...

- Immediately after switch-on, (if necessary, first after a switch-on delay has elapsed and at the beginning of a soft ON dimming procedure / also after a staircase function),
- after switch-off, (if necessary, first after a run-on-time has elapsed and at the end of a soft OFF dimming procedure / also after a staircase function),
- immediately after switching off by means of the automatic switch-off function,
- at the beginning of a dimming procedure when dimming ON (relatively high dimming or brightness value = 1...100 %),
- at the end of a dimming procedure when dimming OFF (brightness value = 0 %),
- If the switching state changes in normal operation (therefore not for dimming procedures that do not change the switching state e.g. from 10 % to 50 % brightness),
- At the start or end of a disabling or forced position function (if the switching state changes as a result),
- On scene recall or effect run-through (always when the switching state changes as a result),
- On bus/mains voltage return or at the end of an ETS programming operation (possibly also delayed / exception: "No change").

The brightness value feedback object is updated after the following events...

- at the end of a relative (4-bit) or absolute (1-byte) dimming procedure.
- after switch-on, if the switch-on brightness is set (if necessary, first after a switch-on delay has elapsed and at the end of a soft ON dimming procedure / also after a staircase function),
- after switch-off, (if necessary, first after a run-on-time has elapsed and at the end of a soft OFF dimming procedure / also after a staircase function),
- immediately after switching off by means of the automatic switch-off function,
- if, in normal operation, the brightness value changes (if a brightness value specification exceeds/undershoots the maximum/minimum brightness as a result of relative or absolute dimming from outside or exceeds the maximum brightness, the Gateway updates brightness value feedback according to the maximum brightness or minimum brightness),
- at the start or end of a disabling or forced position function (if the brightness value changes as a result),
- on scene recall or effect run-through (if the brightness value changes as a result),
- always on bus/mains voltage return or at the end of an ETS programming operation (possibly also delayed / exception: "No change").

- i** In the case of enabling function as supplementary function: A flashing DALI group or single device is always signalled back as "switched on" and with switch-on brightness. Switching status feedbacks are also transmitted for disabled groups or devices when the outputs are readjusted by a manual operation, for example.

Activate switching status feedback

The switching status feedback can be used as an active message object or as a passive status object. As an active message object, the switching status feedback is also directly transmitted to the bus whenever there is an update. As a passive status object, there is no telegram transmission after an update. In this case, the object value must be read out. The ETS automatically sets the object communication flags required for proper functioning.

The parameter "Feedback switching status ?" is available separately for each DALI group or each single device in the parameter node "Addressing -> Groups ... - [x] Group -> Switching" or "Addressing -> Single devices ... - [x] Electronic ballast -> Switching".

- Set the parameter to "yes, feedback object is active signalling object".

The "Switching status feedback" object is enabled. The switching status is transmitted once the status is updated. An automatic telegram transmission of the feedback takes place after bus/mains voltage return or after programming with the ETS (exception: "No change").

- Set the parameter to "yes, feedback object is passive status object".

The "Switching status feedback" object is enabled. The switching status will be transmitted in response only if the feedback object is read out from by the bus. No automatic telegram transmission of the feedback takes place after bus or mains voltage return or after programming with the ETS.

Presetting update of the switching status feedback

In the ETS you can specify when the Gateway should update the feedback value for the switching status in case of an actively transmitting communication object. The object value updated by the Gateway is then signalled actively to the bus.

The parameter "Updating the object value for switching status feedback" is created separately for each DALI group or each single device in the parameter node "Addressing -> Groups ... - [x] Group -> Switching" or "Addressing -> Single devices ... - [x] Electronic ballast -> Switching".

The switching status feedback must be configured to actively transmitting.

- Set the parameter to "After each update of the inputs".

The Gateway updates the feedback value in the object once a new telegram is received on the input objects "Switching" or "Central switching". With an actively transmitting feedback object, a new telegram is also then actively transmitted to the bus each time. The telegram value of the feedback does not necessarily have to change in the process. Hence, a corresponding switching status feedback is also generated on the "Switching" object such as in the case of cyclical telegrams for example.

In addition, feedback is transmitted at the beginning or end of a disabling or forced position function, and also during an effect run-through, even if the feedback state does not change.

- Set the parameter to "Only if the feedback value changes".

The Gateway only updates the feedback value in the object if the telegram value (e.g. "OFF" to "ON") also changes. If the telegram value of the feedback does not change (e.g. in the case of cyclical telegrams to the "Switching" object with the same telegram value), the feedback then remains unchanged. Consequently, with an actively transmitting feedback object, no telegram with the same content will be transmitted repeatedly either. This setting is recommendable, for instance, if the "Switching" and "Switching feedback" objects are linked to an identical group address. This is often the case when activating by means of light scene push-button sensors (recall and storage function).

Setting the switching status feedback on bus or mains voltage return or after programming with the ETS

If used as an active message object, the switching status feedback state is transmitted to the bus after bus or mains voltage return or after programming with the ETS. In these cases, the feedback telegram can be delayed with the delay being preset globally for all DALI groups together (cf. "Delay after bus/mains voltage return").

- Set the parameter "Time delay for feedback after bus voltage return" in the parameter node "Addressing -> Groups ... - [x] Group -> Switching" or "Addressing -> Single devices ... - [x] Electronic ballast -> Switching" to "yes".

The switching status feedback is transmitted after a delay after bus or mains voltage return or after programming with the ETS. No feedback telegram is transmitted during a running delay, even if the switching state changes during this delay.
- Set the parameter "Time delay for feedback telegram after bus voltage return" to "no".

The switching status feedback is transmitted immediately after bus or mains voltage return or after programming with the ETS.
- ⓘ The behaviour of a group or a single device after bus voltage return and after an ETS programming operation can be configured in the ETS and set to "No change". In this case, the communication objects of the Gateway are initialised with "0". In this case, the switching status feedback only corresponds to the 'true' brightness state when the group or the single device has been controlled at least once via the bus or by manual operation. In this setting, feedback objects set as actively transmitting do not transmit a telegram.

Presetting the cyclical transmission function for the switching status feedback telegram

The switching status feedback telegram can also be transmitted cyclically via the active message object in addition to the transmission after updating.

- Set the parameter "Cyclical transmission of feedback telegram?" in the parameter node "Addressing -> Groups ... - [x] Group -> Switching" or "Addressing -> Single devices ... - [x] Electronic ballast -> Switching" to "yes".

Cyclical transmission is activated.
- Set the parameter "Cyclical transmission of feedback telegram" to "no".

Cyclical transmission is deactivated so that the feedback telegram is only transmitted when a switching status is updated.
- ⓘ The cycle time is defined centrally for all DALI groups and single devices in the parameter node "General -> Status and feedback".
- ⓘ During an active delay, no feedback telegram will be transmitted even if a switching state changes.

Activate brightness value feedback

The brightness value feedback can be used as an active message object or as a passive status object. As an active message object, the brightness value feedback information is also directly transmitted to the bus whenever there is an update. As a passive status object, there is no telegram transmission after an update. In this case, the object value must be read out. The ETS automatically sets the object communication flags required for proper functioning.

The parameter "Feedback brightness value ?" is available separately for each DALI group or each single device in the parameter node "Addressing -> Groups ... - [x] Group -> Dimming" or "Addressing -> Single devices ... - [x] Electronic ballast -> Dimming".

- Set the parameter to "yes, feedback object is active signalling object".

The "brightness value feedback" object is enabled. The brightness value is transmitted once this is updated. An automatic telegram transmission of the feedback takes place after bus/mains voltage return or after programming with the ETS (exception: "No change").
- Set the parameter to "yes, feedback object is passive status object".

The "brightness value feedback" object is enabled. The brightness value will be transmitted in response only if the feedback object is read out from by the bus. No automatic telegram transmission of the feedback takes place after bus or mains voltage return or after programming with the ETS.

Presetting update of the brightness value feedback

In the ETS, you can specify when the Gateway should update the feedback value for the brightness value in case of an actively transmitting communication object. The object value updated by the Gateway is then signalled actively to the bus.

The parameter "Updating the object value for brightness value feedback" is created separately for each DALI group or each single device in the parameter node "Addressing -> Groups ... - [x] Group -> Dimming" or "Addressing -> Single devices ... - [x] Electronic ballast -> Dimming".

The brightness value feedback must be configured to "active message object".

- Set the parameter to "After each update of the inputs".

The Gateway updates the feedback value in the object once a new telegram is received on the input object "brightness feedback". With an actively transmitting feedback object, a new telegram is also then actively transmitted to the bus each time. The telegram value of the feedback does not necessarily have to change in the process. Hence, a corresponding brightness value feedback is also generated on the "brightness value feedback" object such as in the case of cyclical telegrams for example.

In addition, feedback is transmitted at the beginning or end of a disabling or forced position function, and also during an effect run-through, even if the feedback value does not change.

- Set the parameter to "Only if the feedback value changes".

The Gateway only updates the feedback value in the object if the telegram value (e.g. "0 %" to "100 %") also changes. If the telegram value of the feedback does not change (e.g. in the case of cyclical telegrams to the "brightness value" object with the same telegram value), the feedback then remains unchanged. Consequently, with an actively transmitting feedback object, no telegram with the same content will be transmitted repeatedly either.

This setting is recommendable, for instance, if the "brightness value" and "brightness value feedback" objects are linked to an identical group address. This is often the case when activating by means of light scene push-button sensors (recall and storage function).

Setting the brightness value feedback on bus or mains voltage return or after programming with the ETS

If used as an active message object, the brightness value feedback state is transmitted to the bus after bus or mains voltage return or after programming with the ETS. In these cases, the feedback telegram can be delayed with the delay being preset globally for all DALI groups together (cf. "Delay after bus/mains voltage return").

- Set the parameter "Time delay for feedback after bus voltage return" in the parameter node "Addressing -> Groups ... - [x] Group -> Dimming" or "Addressing -> Single devices ... - [x] Electronic ballast -> Dimming" to "yes".

The brightness value feedback is transmitted after a delay after bus or mains voltage return or after programming with the ETS. No feedback telegram is transmitted during a running delay, even if the brightness value changes during this delay.

- Set the parameter "Time delay for feedback telegram after bus voltage return" to "no".

The brightness value feedback is transmitted immediately after bus or mains voltage return or after programming with the ETS.

- i** The behaviour of a group or a single device after bus voltage return and after an ETS programming operation can be configured in the ETS and set to "No change". In this case, the communication objects of the Gateway are initialised with "0". In this case, the brightness value feedback only corresponds to the 'true' brightness state when the group or the single device has been controlled at least once via the bus or by manual operation. In this setting, feedback objects set as actively transmitting do not transmit a telegram.

Presetting the cyclical transmission function for the brightness value feedback telegram

The brightness value feedback telegram can also be transmitted cyclically via the active message object in addition to the transmission after updating.

- Set the parameter "Cyclical transmission of feedback telegram?" in the parameter node "Addressing -> Groups ... - [x] Group -> Dimming" or "Addressing -> Single devices ... - [x] Electronic ballast -> Dimming" to "yes".
Cyclical transmission is activated.
- Set the parameter "Cyclical transmission of feedback telegram" to "no".
Cyclical transmission is deactivated so that the feedback telegram is only transmitted to the bus when the brightness value is updated.
- i** The cycle time is defined centrally for all DALI groups and single devices in the parameter node "General -> Status and feedback".
- i** During an active delay, no feedback telegram will be transmitted even if a brightness value changes.

Feedback of the colour temperature

The DALI Gateway can track the set colour temperature of a DALI group and single device via a separate 2-byte feedback object according to DPT 7.600 and can also transmit it to the bus, if the bus voltage is on. In addition, the Gateway can display whether an externally specified colour temperature is valid (object value "ON") or invalid (object value "OFF") by means of a separate 1-bit feedback object. An invalid colour temperature exists if the specified value violates the set limits of the minimum and maximum colour temperature.

The Gateway determines the object value of the feedback objects each time the colour temperature is influenced. The Gateway tracks the colour temperature value and updates the feedback objects even when a group or single device is activated by the scene function or by using effects.

The feedback object "FB absolute colour temperature (K)" is updated after the following events...

- after a completed relative or absolute dimming operation of the colour temperature, but only if the DALI group or single device is also switched on after mains voltage return (brightness unequal "0 %"),
- immediately after switching on a DALI group or single device, but only if the colour temperature value differs from the last value that was fed back,
- on scene recall or effect run-through (always when the colour temperature changes as a result),
- after bus voltage return (possibly also delayed), but only if the DALI group or single device is also switched on after mains voltage return (brightness unequal "0 %"),
- after mains voltage return (possibly also delayed), but only if the DALI group or single device is activated by the Gateway after mains voltage return (brightness unequal "0 %").
- i** The communication objects of the Gateway are initialised with "0" after an ETS programming operation. In this case, the feedback of the colour temperature only then corresponds to a valid value when the colour temperature of the group or single device was controlled at least once via the KNX and the transmission criterion of the feedback was met. Actively transmitting feedback objects of the colour temperature automatically do not transmit any telegram immediately after an ETS programming operation.

- i** If a colour temperature specification exceeds or undershoots the minimum or maximum colour temperature as a result of relative or absolute dimming specified externally, the Gateway updates a feedback according to the minimum or maximum temperature.

The feedback object "FB invalid colour temperature" is updated after the following events...

- when predefining a new absolute colour temperature via the object "Absolute colour temperature (K)" (depending on the configured transmission behaviour),
- always after a device reset (ETS programming operation, bus/mains voltage return / possibly also delayed), with the status "valid colour temperature".

Activating colour temperature feedback

The colour temperature feedback must first be enabled in the ETS plug-in before it can be used. The parameter "Feedback of the current colour temperature?" enables the feedback and is available separately for each DALI group or each single device in the parameter node "Addressing -> Groups ... - [x] Group -> TW function colour temperature 1" or "Addressing -> Single devices ... - [x] Electronic ballast -> TW function colour temperature 1" created.

- Set parameter to "yes".
The feedback of the colour temperature is available. The object "FB absolute colour temperature (K)" is enabled.
- Set parameter to "no".
The feedback of the colour temperature is not available.

Presetting transmission behaviour of the colour temperature feedback

The colour temperature feedback can be used as an active message object or as a passive status object. As an active message object, the colour temperature feedback is also directly transmitted to the bus whenever there is an update. As a passive status object, there is no telegram transmission after an update. In this case, the object value must be read out. The ETS automatically sets the object communication flags required for proper functioning. The parameter "Feedback of the current colour temperature?" configures the function of the feedback.

- Set the parameter to "Active signalling object".
The feedback of the absolute colour temperature is transmitted once this it updated.
- Set the parameter to "Passive status object".
The feedback of the absolute colour temperature will be transmitted in response only if the feedback object is read out from the bus. No automatic telegram transmission of the feedback takes place after bus or mains voltage return.

Setting update of the colour temperature feedback

In the ETS you can specify when the Gateway should update the feedback value for the current colour temperature in case of an actively transmitting communication object. The object value updated by the Gateway is then signalled actively to the bus.

The parameter "Updating the object value for current colour temperature value feedback" is created separately for each DALI group or each single device in the parameter node "Addressing -> Groups ... - [x] Group -> TW function colour temperature 1" or "Addressing -> Single devices ... - [x] Electronic ballast -> TW function colour temperature 1" created.

The feedback of the current colour temperature must be configured to "active message object".

- Set the parameter to "After each update of the inputs".

The Gateway updates the feedback value in the object once a new telegram is received on the input object "Absolute colour temperature (K)", but only if the DALI group or single device is also switched on. With an actively transmitting feedback object, a new telegram is also then actively transmitted to the bus each time. The telegram value of the feedback does not necessarily have to change in the process. Hence, a corresponding colour temperature feedback is also generated on the object "Absolute colour temperature (K)" such as in the case of cyclical telegrams, for example.

- Set the parameter to "Only if the feedback value changes".

The Gateway only updates the feedback value in the object if the telegram value also changes. This only takes place, however, if the DALI group or single device is also switched on. If the telegram value of the feedback does not change when switched on (e.g. in the case of cyclical telegrams to the "Absolute colour temperature (K)" object with the same telegram value), the feedback then remains unchanged. Consequently, with an actively transmitting feedback object, no telegram with the same content will be transmitted repeatedly either.

This setting is recommendable, for instance, if the "Absolute colour temperature (K)" and "FB absolute colour temperature (K)" objects are linked to an identical group address. This is often the case when activating by means of light scene push-button sensors (recall and storage function).

Setting the colour temperature feedback on bus or mains voltage return

If used as an active message object, the colour temperature feedback state is transmitted to the bus after bus or mains voltage return, but only if the DALI group or single device is also switched on (brightness unequal "0 %"). In these cases, the feedback telegram can be delayed with the delay being preset globally for all DALI groups together (cf. "Delay after bus/mains voltage return").

The feedback of the current colour temperature must be configured to "active message object".

- Set the parameter "Time delay for feedback after bus voltage return" in the parameter node "Addressing -> Groups ... - [x] Group -> TW function colour temperature 1" or "Addressing -> Single devices ... - [x] Electronic ballast -> Set TW function colour temperature 1" to "yes".

The colour temperature feedback is transmitted with a delay after bus or mains voltage return. No feedback telegram is transmitted during a running delay, even if the colour temperature changes during this delay.

- Set the parameter "Time delay for feedback telegram after bus voltage return" to "no".

The colour temperature feedback is transmitted immediately after bus or mains voltage return.

- i** After a mains voltage return, only telegrams corresponding to the effective colour temperature in the DALI Gateway are transmitted when the DALI group or single device is actively on after mains voltage return (brightness unequal "0 %").
- i** The communication objects of the Gateway are initialised with "0" after an ETS programming operation. In this case, the feedback of the colour temperature only then corresponds to a valid value when the colour temperature of the group or single device was controlled at least once via the KNX and the transmission criterion of the feedback was met. Actively transmitting feedback objects of the colour temperature automatically do not transmit any telegram immediately after an ETS programming operation.

Presetting the cyclical transmission of the colour temperature feedback

The colour temperature feedback telegram can also be transmitted cyclically via the active message object in addition to the transmission after updating.

The feedback of the current colour temperature must be configured to "active message object".

- Set the parameter "Cyclical transmission of feedback telegram?" in the parameter node "Addressing -> Groups ... - [x] Group -> TW function colour temperature 1" or "Addressing -> Single devices ... - [x] Electronic ballast -> Set TW function colour temperature 1" to "yes".
Cyclical transmission is activated.
- Set the parameter "Cyclical transmission of feedback telegram" to "no".
Cyclical transmission is deactivated so that the feedback telegram is transmitted to the bus only when updating a colour temperature.
- ⓘ The cycle time is defined centrally for all DALI groups and single devices in the parameter node "General -> Status and feedback".
- ⓘ During an active delay, no feedback telegram will be transmitted even if a colour temperature changes.

Activating "invalid colour temperature" feedback

The feedback of an invalid colour temperature must first be enabled in the ETS plug-in before it can be used. The parameter "Feedback of an invalid colour temperature?" enables the feedback and is available separately for each DALI group or each single device in the parameter node "Addressing -> Groups ... - [x] Group -> TW function colour temperature 2" or "Addressing -> Single devices ... - [x] Electronic ballast -> TW function colour temperature 2" created.

- Set parameter to "yes".
The feedback of an invalid colour temperature is available. The object "FB invalid colour temperature" is enabled.
- Set parameter to "no".
The feedback of an invalid colour temperature is not available.

Presetting transmission behaviour of the "invalid colour temperature" feedback

The feedback of an invalid colour temperature can be used as an active message object or as a passive status object. As an active message object, the feedback is also directly transmitted to the bus whenever there is an update of the object "FB absolute colour temperature (K)". As a passive status object, there is no telegram transmission after an update. In this case, the object value must be read out. The ETS automatically sets the object communication flags required for proper functioning.

The parameter "Feedback of an invalid colour temperature?" configures the function of the feedback.

- Set the parameter to "Active signalling object".
The feedback of an invalid colour temperature is transmitted once this it updated.
- ⓘ After a device reset (ETS programming operation, mains voltage return), the status "valid colour temperature" is always transmitted if an object is actively transmitting.
- Set the parameter to "Passive status object".
The feedback of an invalid colour temperature will be transmitted in response only if the feedback object is read out from the bus.

Presetting update of the "invalid colour temperature" feedback

In the ETS you can specify when the Gateway should update the feedback value for an invalid colour temperature in case of an actively transmitting communication object. The object value

updated by the Gateway is then signalled actively to the bus.

The parameter "Updating the object value for invalid colour temperature value feedback" is created separately for each DALI group or each single device in the parameter node "Addressing -> Groups ... - [x] Group -> TW function colour temperature 2" or "Addressing -> Single devices ... - [x] Electronic ballast -> TW function colour temperature 2" created.

The feedback of an invalid colour temperature must be configured to "active message object".

- Set the parameter to "After each update of the inputs".

The Gateway updates the feedback value in the object once a new telegram is received on the input object "Absolute colour temperature (K)". With an actively transmitting feedback object, a new telegram is also then actively transmitted to the bus each time. The telegram value of the feedback does not necessarily have to change in the process. Hence, a corresponding "invalid colour temperature" feedback is also generated on the "Absolute colour temperature (K)" object, such as in the case of cyclical telegrams for example.

- Set the parameter to "Only if the feedback value changes".

The Gateway only updates the feedback value in the object if the telegram value also changes. If the telegram value of the feedback does not change (e.g. in the case of cyclical telegrams to the "Absolute colour temperature (K)" object with the same telegram value), the feedback then remains unchanged. Consequently, with an actively transmitting feedback object, no telegram with the same content will be transmitted repeatedly either.

Setting the "invalid colour temperature" feedback on bus or mains voltage return or after an ETS programming operation

If used as an active message object, the switching status feedback of an invalid colour temperature is transmitted to the bus after bus or mains voltage return or after an ETS programming operation. In these cases, the feedback telegram can be delayed with the delay being preset globally for all DALI groups together (cf. "Delay after bus/mains voltage return").

The feedback of an invalid colour temperature must be configured to "active message object".

- Set the parameter "Time delay for feedback after bus voltage return" in the parameter node "Addressing -> Groups ... - [x] Group -> TW function colour temperature 2" or "Addressing -> Single devices ... - [x] Electronic ballast -> Set TW function colour temperature 2" to "yes".

The "invalid colour temperature" feedback is transmitted with a delay after bus or mains voltage return or after an ETS programming operation. No feedback telegram is transmitted during a running delay, even if the colour temperature changes during this delay.

- Set the parameter "Time delay for feedback telegram after bus voltage return" to "no".

The "invalid colour temperature" feedback is transmitted immediately after bus or mains voltage return or after an ETS programming operation.

- i** After a device reset (ETS programming operation, mains voltage return), the status "valid colour temperature" is always transmitted if an object is actively transmitting.

Presetting the cyclical transmission of the "invalid colour temperature" feedback

The feedback telegram of an invalid colour temperature can also be transmitted cyclically via the active message object in addition to the transmission after updating.

The feedback of an invalid colour temperature must be configured to "active message object".

- Set the parameter "Cyclical transmission of feedback telegram?" in the parameter node "Addressing -> Groups ... - [x] Group -> TW function colour temperature 2" or "Addressing -> Single devices ... - [x] Electronic ballast -> Set TW function colour temperature 2" to "yes".

Cyclical transmission is activated.

- Set the parameter "Cyclical transmission of feedback telegram" to "no".
Cyclical transmission is deactivated so that the feedback telegram is transmitted to the bus only when updating the feedback.
- ❗ The cycle time is defined centrally for all DALI groups and single devices in the parameter node "General -> Status and feedback".

4.2.4.3.6 Automatic switch-off

Automatic switch-off

The switch-off function permits automatic switching of a DALI group or a single device after a brightness value was dimmed or jumped to and this new brightness value is below a switch-off brightness set in the ETS. A delay can be configured optionally until switching off (figure 41).

The switch-off function is activated after reaching a constant brightness value, i.e. after a completed dimming procedure through absolute or relative dimming. A new dimming operation, which ends below switch-off brightness starts, starts any time delay which may be present. In the same way, the switch-off function is interrupted if the switch-off brightness is exceeded during a dimming operation.

The automatic switch-off function, for example, not only makes it possible to set the lighting to minimum brightness but to switch off by means of relative dimming as well. A further application, for example, is time-controlled "Good night switch-off" of a dimmed children's room lighting.

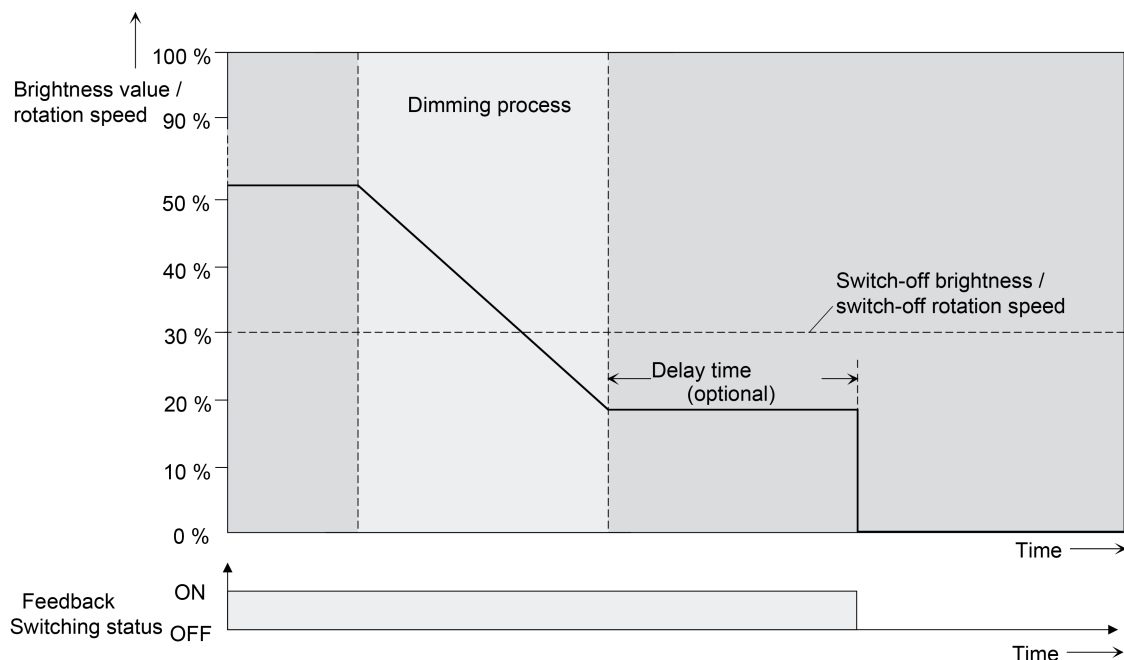

Figure 41: Dimming and switching behaviour of the automatic switch-off function

- i** Switching off always takes place without soft OFF function, i.e. jumping.
- i** The switch-off brightness in the dimmable brightness range can be set between the configured maximum and minimum brightness. Automatic switch-off does not take place if "Switch-off brightness = Minimum brightness" is set, since the switch-off brightness cannot be undershot. The switch-off function is always active if the switch-off brightness is configured to maximum brightness and the maximum brightness is randomly undershot.
- i** The feedback objects for switching state and brightness value are updated by the automatic switch-off function after switching off.

The switch-off function can also be combined with other functions of the DALI Gateway. It should be noted that the disabling function, the forced position function, the scene function and the effect function override the switch-off function. The automatic switch-off can only be activated by a dimming procedure initiated via the 4-bit ("dimming") or 1-byte ("brightness value") communication object. If the switch-off function is overridden, the DALI Gateway terminates the processing of the delay time and the evaluation of the switch-off brightness. Switching on (switch-on brightness) using the communication object "Switching" does not activate the switch-off function.

Enabling automatic switch-off function

In the plug-in of the DALI Gateway, the automatic switch-off function can be set separately for each group and each single device.

- Set the parameter "Automatic switch-off when undershooting a brightness ?" in the parameter node "Addressing -> Groups ... - [x] Group -> Dimming" or "Addressing -> Single devices ... - [x] Electronic ballast -> Dimming" to "yes".

The automatic switch-off function is enabled. Additional parameters become visible.

Setting the switch-off brightness

The switch-off brightness must be defined for the switch-off function. The switch-off function is set separately for each DALI device and each single device.

The switch-off function must be enabled.

- Set the parameter "Switch-off when brightness value less than" in the parameter node "Addressing -> Groups ... - [x] Group -> Dimming" or "Addressing -> Single devices ... - [x] Electronic ballast -> Dimming" to the required brightness value.

Once a dimming procedure causes a value to fall below the parameterised shutoff brightness and once the brightness has been set to constant, the DALI group or the single device switches off or alternatively starts the delay until switching off. The parameter selection is restricted to the limits of the minimum and maximum brightness.

Setting the delay of the switch-off function

A time delay can be activated before the switch-off function switches-off automatically after undershooting the switch-off brightness at the end of a dimming procedure. The time delay can optionally be enabled separately for each DALI group and each single device.

The switch-off function must be enabled.

- Set the parameter "Delay until switching off ?" in the parameter node "Addressing -> Groups ... - [x] Group -> Dimming" or "Addressing -> Single devices ... - [x] Electronic ballast -> Dimming" to "yes". Configure the parameter "Delay until switching off" to the required time.

Once a dimming procedure causes a value to fall below the parameterised shutoff brightness and once the brightness has been set to constant, the DALI Gateway triggers the delay time. The DALI Group or the single device concerned switches off for good once the delay time has elapsed. The delay time can be re-triggered by further dimming procedures.

4.2.4.3.7 Switch-on and switch-off behaviour

Time delays

Up to two time functions can be preset independently of each other for each DALI group and each single device. The time functions affect the communication objects "Switching" or "Central function switching" only (if the central function is activated for the group or the single device) and delay the object value received depending on the telegram polarity .

Activating switch-on delay

The switch-on delay can be set separately in the plug-in of the DALI Gateway for each group and each single device.

- In the parameter node "Addressing -> Groups ... - [x] Group -> Switch-on/Switch-off behaviour" or "Addressing -> Single devices ... - [x] Electronic ballast -> Switch-on/Switch-off behaviour", set the parameter "Selection of time delay" to "Switch-on delay" or to "switch-on delay and switch-off delay". Configure the desired switch-on delay.

The switch-on delay is enabled. After reception of an ON telegram via the "switching" object, the configurable time is started. Another ON-telegram triggers the time only when the parameter "Switch-on delay retriggerable " is set to "yes". An OFF-telegram received during the ON-delay will end the delay and sets the switching status to "OFF".

Activating switch-off delay

The switch-off delay can be set separately in the plug-in of the DALI Gateway for each group and each single device.

- In the parameter node "Addressing -> Groups ... - [x] Group -> Switch-on/Switch-off behaviour" or "Addressing -> Single devices ... - [x] Electronic ballast -> Switch-on/Switch-off behaviour", set the parameter "selection of time delay" to "switch-off delay" or to "switch-on delay and switch-off delay". Configure the desired switch-off delay.

The switch-off delay is enabled. After reception of an OFF-telegram via the "switching" object, the configurable time is started. Another OFF-telegram triggers the time only when the parameter "switch-off delay retriggerable ?" is set to "yes". An ON-telegram received during the OFF-delay will end the delay and sets the switching status to "ON".

- i** Feedback: If a time delay has been preset and if the switching state is changed via the "Switching" object, the time delay must have elapsed before feedback telegrams will be transmitted.
- i** At the end of a disabling function or forced position function, the brightness state received during the function or adjusted before the function can be tracked. Residual times of time functions are also tracked if these had not yet fully elapsed at the time of the reactivation or forced control.
- i** The time delays do not influence the staircase function if this is enabled.
- i** A time delay still in progress will be fully aborted by a reset of the actuator (bus/ mains voltage failure or ETS programming).

Soft ON/OFF function

The soft-functions permit a DALI group or a single device to be switched on or off at reduced speed when a switching command is received via the "Switching" or "Central switching function" communication objects. If the soft ON function is activated, a dimming procedure is executed until the switch-on brightness when switching on. This also occurs if the DALI group of the single device is already switched on to a brightness value smaller than switch-on brightness.

Likewise, with the soft OFF function, a dimming procedure is executed to 0 % brightness after receipt of an OFF telegram (figure 42).

The dimming speeds can be configured separately in the ETS plug-in for the soft ON and soft OFF function. Just as with relative or absolute dimming, the dimming time is specified for the entire brightness range, and thus for a brightness change from 0 % to 100 %. The DALI Gateway uses the stated dimming time to calculate the dimming speed for a dimming step of the soft functions.

The soft ON or soft OFF functions are not retriggerable by the receipt of further switching telegrams while maintaining the switching status. The soft functions can be activated and configured separately in the ETS plug-in.

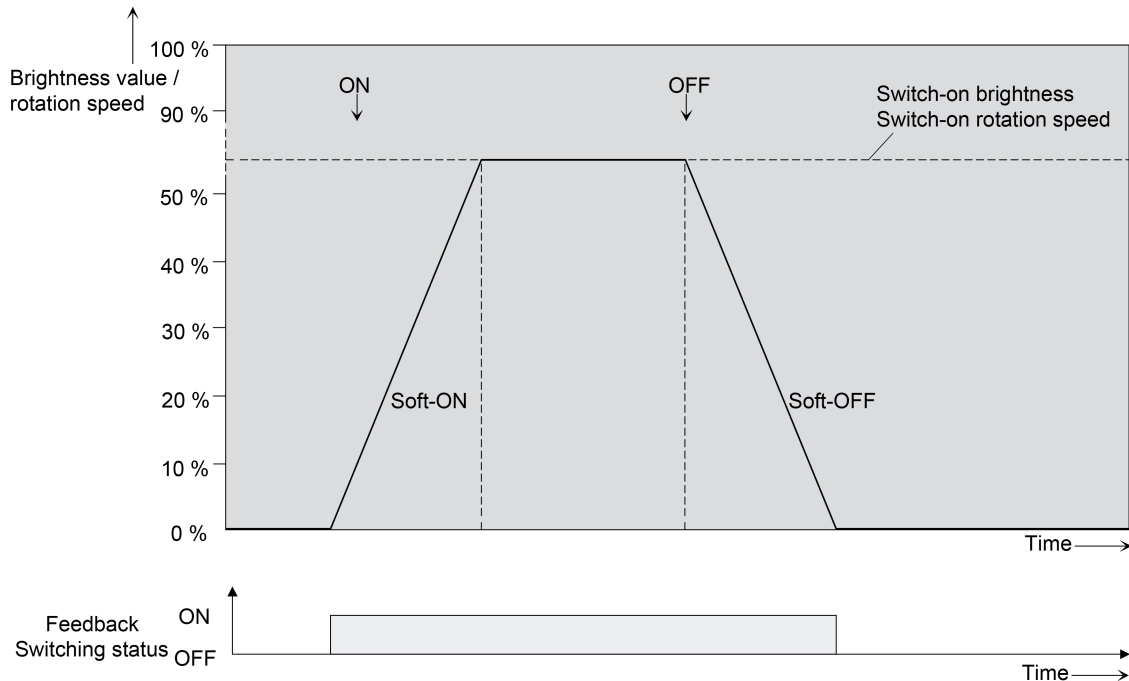

Figure 42: Dimming behaviour of the soft ON/OFF functions with minimum brightness > 0%

- i** The dimming operation of a Soft ON function starts at the minimum brightness configured in the ETS plug-in. If a DALI group or a single device is switched off (brightness value = 0 %) and is then switched on, the operating devices jump to the configured minimum brightness and start with the Soft ON dimming operation to the switch-on brightness.
- i** The soft functions also have effects on the switching edges of the staircase function.
- i** A DALI group or individual disabled via the bus can also flash depending on the ETS configuration for the disabling function. Dimming is not executed with the soft functions during ON and OFF flashing.

Enabling and setting soft ON function

In the plug-in of the DALI Gateway, the Soft ON function can be set separately for each group and each single device.

- Set the parameter "Soft ON function ?" in the parameter node "Addressing -> Groups ... - [x] Group -> Switch-on/Switch-off behaviour" or "Addressing -> Single devices ... - [x] -> Switch-on/switch-off behaviour" to "yes".

The soft ON function is enabled. The parameter for the dimming time of the soft ON function becomes visible.

- Configure the parameter "Time for soft ON (0...100 %)" to the required dimming time.

Enabling and setting soft OFF function

In the plug-in of the DALI Gateway, the Soft OFF function can be set separately for each group and each single device.

- Set the parameter "Soft OFF function ?" in the parameter node "Addressing -> Groups ... - [x] Group -> Switch-on/Switch-off behaviour" or "Addressing -> Single devices ... - [x] -> Switch-on/switch-off behaviour" to "yes".

The soft OFF function is enabled. The parameter for the dimming time of the soft OFF function becomes visible.

- Configure the parameter "Time for soft OFF (0...100 %)" to the required dimming time.

4.2.4.3.8 Staircase function

Staircase function

The staircase function that can be configured separately can be used for implementing time-controlled lighting of a staircase or for function-related applications. The staircase function must be enabled in the parameter node "Addressing -> Groups ... -> [x] Group name -> Staircase function" or "Addressing -> Single devices ... -> [x] Device name -> Staircase function", in order for the required communication objects and parameters to be visible.

The staircase function is activated via the communication object "Staircase function start / stop" and is independent of the "switching" object. In this way, parallel operation of time control and normal control is possible, whereby the last command received is always executed:

A telegram to the "switching" object at the time of an active staircase function aborts the staircase time prematurely and presets the switching state according to the received object value (the time delays are also taken into account) or scene value. Likewise, the switching state of the "switching" object can be overridden by a staircase function.

Time-independent continuous light switching can also be implemented in combination with a disabling function because the disabling function has a higher priority and overrides the switching state of the staircase function (see page 104).

The staircase function can also be extended by means of a supplementary function. At the same time, it is possible to activate a time extension. The "time extension" permits retriggering of an activated staircase via the object "Staircase function Start / Stop" n times. Alternatively, the "Time preset via the bus" can be set. With this supplementary function, the configured staircase time can be multiplied by a factor received via the bus, thus it can be adapted dynamically.

Furthermore, an extension of the staircase function can be implemented by means of a pre-warning function. During the pre-warning, the brightness can be reduced. The pre-warning should warn people in the staircase that the light will soon be switched off. As an alternative to the pre-warning at the end of the staircase time, the actuator can activate reduced continuous lighting. In this way, for example, long, dark hallways can have permanent basic lighting.

Specifying switch-on behaviour of the staircase function

An ON telegram to the "Staircase function start/stop" object activates the staircase time (T_{ON}), the duration of which is defined by the "Staircase time" parameters. The DALI group or the single device switches to switch-on brightness.

At the end of the staircase time, the DALI group or the single device shows the "reaction at the end of the staircase time" configured in the ETS. At the same time, the DALI group or the single device can switch off, optionally activate the pre-warning time ($T_{Prewarn}$) of the pre-warning function (see page 125-126) or dim to the reduced continuous lighting (application: e.g. long, dark hallways). Taking into account any possible pre-warning function, this gives rise to the example switch-on behaviour of the staircase function (figure 43).

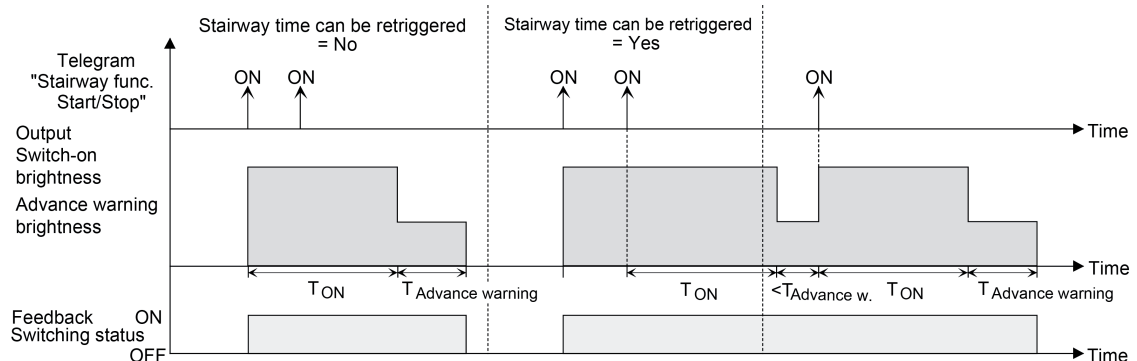

Figure 43: Switch-on behaviour of the staircase function without soft functions

In addition, switching on can be influenced by the soft functions of the DALI Gateway. Taking into account any soft ON and soft OFF function, this gives rise to the switch-on behaviour of the staircase function shown below (figure 44).

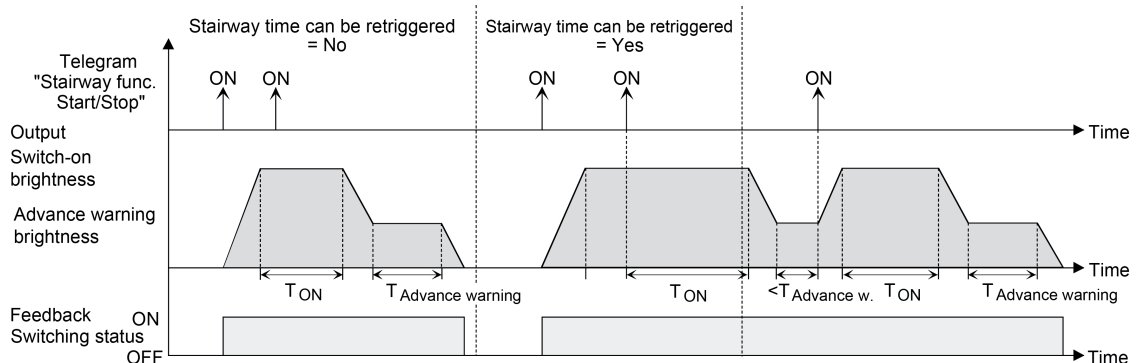

Figure 44: Switch-on behaviour of the staircase function with soft functions (as an example with minimum brightness = 0 %)

- Set the parameter "Staircase function ?" in the parameter node "Addressing -> Groups ... -> [x] Group -> Staircase function" or "Addressing -> Single devices ... -> [x] Electronic ballast -> Staircase function" to "yes".
The staircase function is enabled. Additional parameters become visible.
 - In the "Staircase time" parameter, configure the necessary switch-on time of the staircase function.
 - Set the parameter "Staircase time retriggerable ?" to "yes".
Every ON telegram received during the ON phase of the staircase time retriggers the staircase time completely.
 - The parameter "Staircase time retriggerable ?" is alternatively to "no".
ON telegrams received during the ON phase of the staircase time are rejected. The staircase time is not retriggered.
- i** An ON telegram received during the pre-warning time or during the reduced continuous lighting triggers the staircase time independently of the parameter "Staircase time retriggerable ?" always afterwards.

Specifying switch-off behaviour of the staircase function

In the case of a staircase function, the reaction to an OFF telegram can also be configured on the object "Staircase function start/stop". Without receiving an OFF telegram, at the end of the staircase time, the DALI group or the single device always shows the "Reaction at the end of the staircase time" configured in the ETS. At the same time, the DALI group or the single device can switch off, optionally activate the pre-warning time ($T_{Prewarn}$) of the pre-warning function or dim to the reduced continuous lighting (application: e.g. long, dark hallways).

If, on the other hand, the DALI Group or the single device receives an OFF telegram via the object "Staircase function start/stop", the actuator evaluates the parameter "Reaction to an OFF-telegram". In this case, the channel can react immediately to the OFF telegram and end the staircase time prematurely. Alternatively, the OFF telegram can be ignored.

Taking into account any possible pre-warning function, this gives rise to the example switch-off behaviour of the staircase function (figure 45).

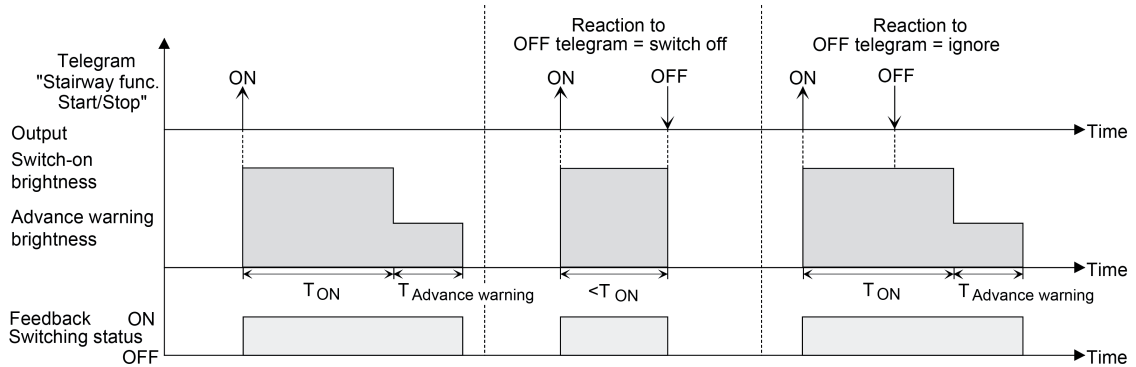

Figure 45: Switch-off behaviour of the staircase function without soft functions

In addition, switching off can be influenced by the soft functions of the DALI Gateway. Taking into account any soft ON and soft OFF function, this gives rise to the switch-off behaviour of the staircase function shown below (figure 46).

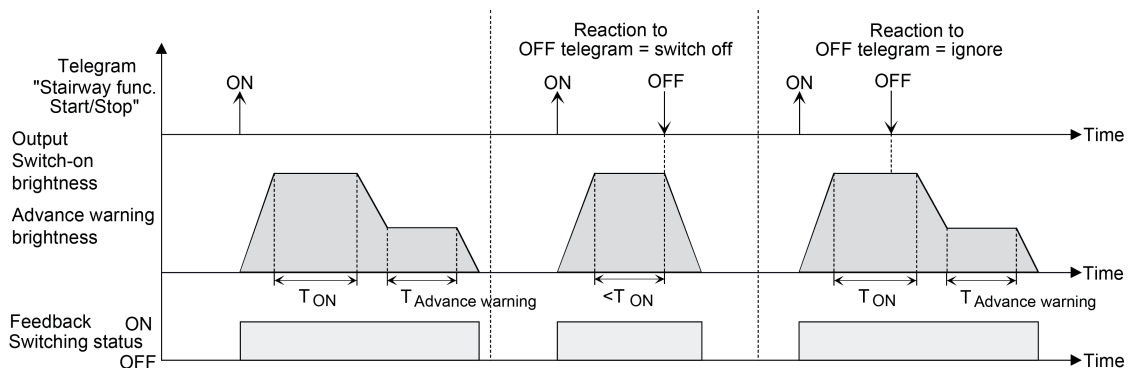

Figure 46: Switch-off behaviour of the staircase function with soft functions (as an example with minimum brightness = 0 %)

The parameter "reaction to OFF-telegram" defines whether the staircase time (T_{EIN}) of the staircase function can be aborted prematurely. This parameter is located in the parameter node "Addressing -> Groups ... -> [x] Group -> Staircase function" or "Addressing -> Single devices ... -> [x] Electronic ballast -> Staircase function" and relates exclusively to the "Staircase function start / stop" object.

The staircase function must be enabled.

- Set parameter "Reaction to OFF-telegram" to "switch off".

Once an OFF telegram is received via the object "Staircase function start/stop" during the ON phase of the staircase time, the operating devices switch off immediately. If the staircase time is stopped prematurely by such a telegram, there is no pre-warning, i.e. the pre-warning time is not started. It is also not dimmed to a reduced continuous lighting. It is also possible to switch off prematurely during a dimming procedure of a soft function or during a pre-warning or reduced continuous lighting.

- Set parameter "Reaction to OFF-telegram" to ignore".

OFF telegrams received via the object "Staircase function start / stop" during the ON phase of the staircase function are rejected. The staircase time will be executed completely to the end with the configured "behaviour at the end of the staircase time".

Setting the pre-warning function of the staircase function

At the end of the switch-on time of the staircase function, the DALI group or the single device shows the "Reaction at the end of the staircase time" configured in the ETS. The DALI group or the single device can be set to switch off immediately, alternatively to dim to the reduced continuous lighting (application: e.g. long, dark hallways) or to execute the pre-warning function. If the parameter is configured to "activate pre-warning time", the pre-warning time ($T_{Vorwarn}$) and pre-warning brightness can be configured in the ETS plug-in.

The pre-warning should warn people still on the staircase that the light will soon be switched off. As a pre-warning, the operating devices can be set to a pre-warning brightness before they switch off permanently. The pre-warning brightness is normally reduced in the brightness value compared to the switch-on brightness. The pre-warning time ($T_{Prewarn}$) and the pre-warning brightness can be configured separately (figure 47). The pre-warning time is added to the staircase time (T_{EIN}). The pre-warning time influences the values of the feedback objects so that the switching state "OFF" and the value "0" are first tracked after the pre-warning time in the feedback objects has elapsed.

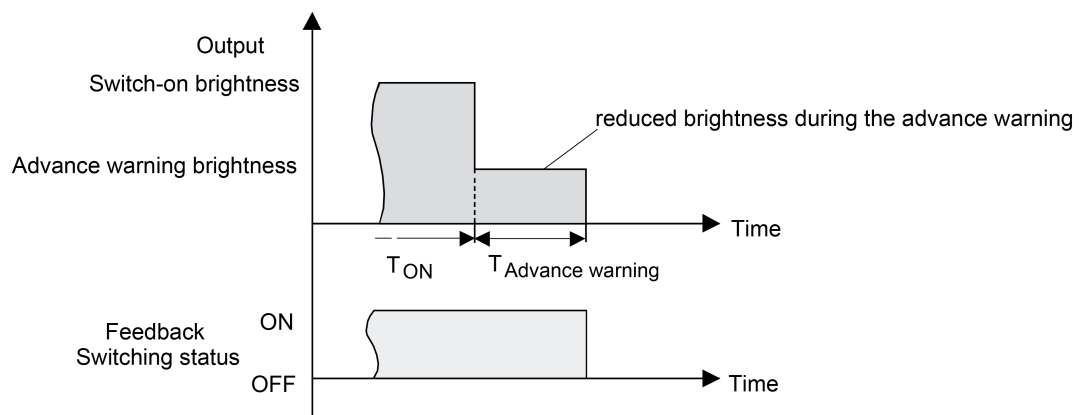

Figure 47: The pre-warning function of the staircase function without soft OFF function

Additionally, the pre-warning function can also be extended by the soft OFF function. Taking into account any soft ON and soft OFF function, this gives rise to the switch-off behaviour of the staircase function shown below after the pre-warning has elapsed (figure 48).

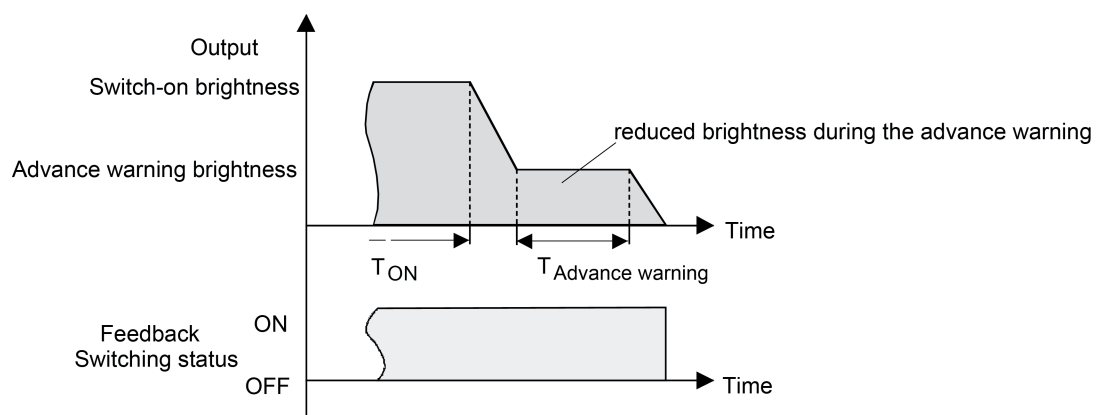

Figure 48: The pre-warning function of the staircase function with soft OFF function (as an example with minimum brightness = 0 %)

- i The pre-warning brightness does not necessarily have to be less than the switch-on brightness. The pre-warning brightness can always be configured to values between maximum brightness and minimum brightness.

The staircase function must be enabled.

- In the parameter node "Addressing -> Groups ... ->[x] Group -> Staircase function" or "Addressing -> Single devices ... -> [x] Electronic ballast -> Staircase function", set the parameter "Reaction at the end of the staircase time" to "Activate pre-warning time".
The pre-warning function is enabled. The desired pre-warning time (T_{Vorwarn}) can be preset.
- Configure the "pre-warning time".
- Set the parameter "Reduced brightness" to the desired brightness value.
During the pre-warning time, the dimming channel is set to the configured brightness value.
- i** An ON telegram to the object "Staircase function start/stop" while a pre-warning function is still in progress stops the pre-warning time and always starts (independently of the parameter "Staircase time retriggerable?") the staircase time anew. Even during the pre-warning time, the parameter "reaction to OFF telegram" is evaluated so that a pre-warning in progress can be terminated early by switching off.
- i** Using the automatic switch-off function: The reduced brightness of the pre-warning does not start the switch-off function after reaching or undershooting the switch-off brightness!

Setting continuous lighting of the staircase function

At the end of the switch-on time of the staircase function, the Gateway shows the "Reaction at the end of the staircase time" configured in the ETS for the appropriate DALI group or the single device. The DALI group or the single device can be set to switch off immediately, alternatively to execute a pre-warning function, or to dim to the reduced continuous lighting. The reduction of the lighting to continuous lighting after the staircase time has elapsed is appropriate, for example, if a certain degree of artificial light should be switched on permanently in long, dark hallways. Switching to switch-on brightness by activating the staircase function normally takes place by additional presence detectors or motion detectors when people are present in the hallway.

If the parameter "Reaction at the end of the staircase time" is configured to "activate reduced continuous lighting", the brightness for the continuous lighting can be configured in the ETS. The continuous brightness is normally reduced in the brightness value compared to the switch-on brightness (figure 49).

The continuous lighting remains permanently active after the staircase time has elapsed. Only when an ON telegram is received again via the object "Staircase function start/stop" does the DALI Gateway switch back to the switch-on brightness and start counting the staircase time again. The receipt of an OFF telegram via the object "Staircase function start/stop" only switches the continuous lighting off if the parameter "Reaction to OFF-telegram" is configured to "Switch off".

- i** A DALI group or a single device can always be switched on and off via the "Switching" object, independently of the Staircase function. Consequently, continuous lighting will also be overridden if telegrams arrive via the "Switching" object.
If permanent continuous lighting is desired, which cannot be influenced by the "Switching" object nor by the object of the staircase function, the disabling function should be used.

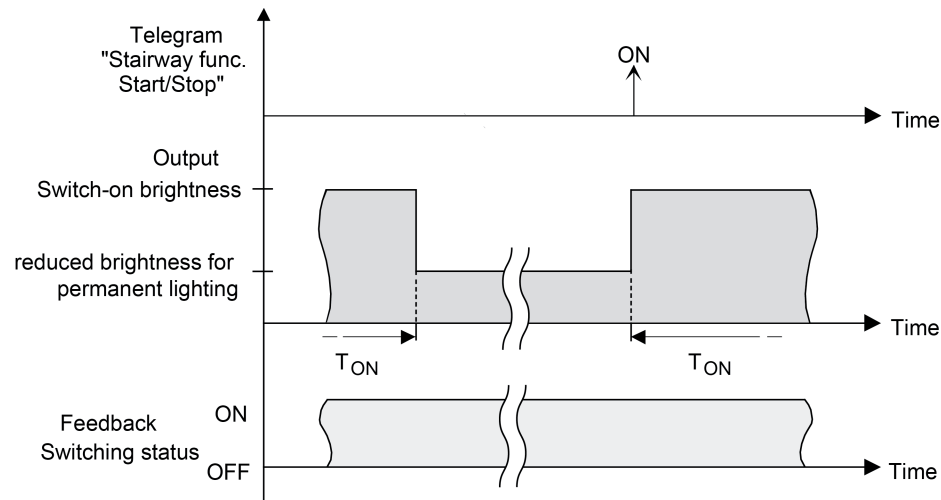

Figure 49: The continuous lighting of the staircase function without soft functions

Additionally, the continuous lighting can also be extended by the soft function. Taking into account any soft ON and soft function, this gives rise to modified continuous lighting behaviour of the staircase function (figure 50).

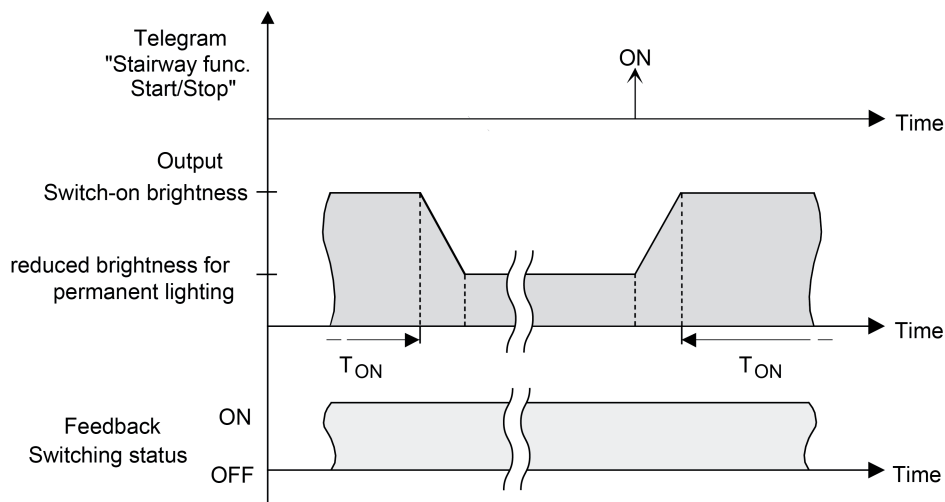

Figure 50: The continuous lighting of the staircase function with soft OFF functions

- i** The brightness of the continuous lighting does not necessarily have to be less than the switch-on brightness. The brightness of the continuous lighting can always be configured to values between basic/minimum brightness and maximum brightness.

The staircase function must be enabled.

- In the parameter node "Addressing -> Groups ... -> [x] Group -> Staircase function" or "Addressing -> Single devices ... -> [x] Electronic ballast -> Staircase function", set the parameter "Reaction at the end of the staircase time" to "Activate reduced permanent lighting".
 The continuous lighting is enabled. The "Reduced brightness" can be set to the desired brightness value.

- i** The configured value for the reduced brightness must be greater than or equal to the minimum brightness (if configured) or less than or equal to the maximum brightness!
- i** An ON telegram to the object "Staircase function start/stop" always starts (independently of the parameter "Staircase time retriggerable?") the staircase time anew. Even during activated continuous lighting, the parameter "Reaction to OFF telegram" is evaluated so that continuous lighting can be switched off.
- i** Using the automatic switch-off function: The reduced brightness of the continuous lighting does not start the switch-off function after reaching or undershooting the switch-off brightness!

Setting supplementary function of the staircase function – time extension

With the time extension function, the staircase time can be retriggered several times (i.e. extended) via the "Staircase function start/stop" object. The duration of the extension is predefined by several operations at the control section (several ON telegrams in succession). The configured staircase time can be extended in this way within a time period by a maximum of the configured factor (a maximum of 5-fold). The time is then always extended automatically at the end of a single staircase time (T_{EIN}).

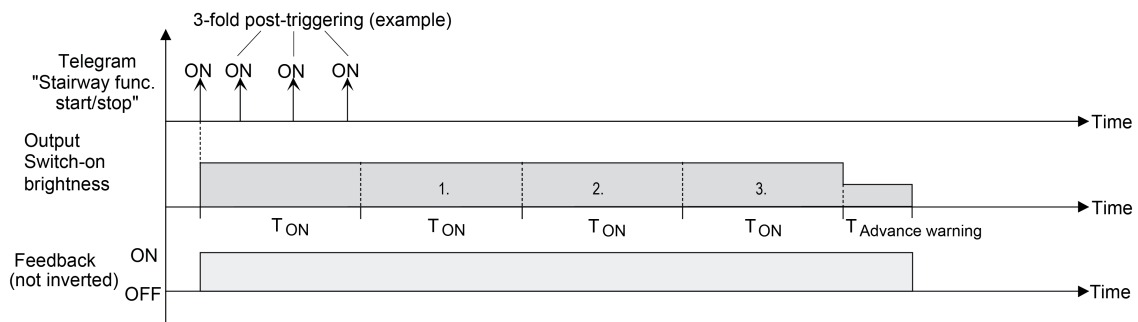

Figure 51: Time extension of the staircase function

With this function, the duration of a switched on light in a staircase can be extended (e.g. by a person after shopping) by a defined length of time without having to retrigger the switch-on time of the lighting every time the lighting shuts off automatically.

- Set the parameter "Supplementary function for staircase function" to "time extension" and set the maximum desired factor on the parameter "maximum time extension".

Each time an ON telegram is received on the object "Staircase function start/stop", the staircase time is extended automatically by retriggering after it has elapsed. The number of telegrams received determines how often the staircase time is retriggered. The retriggering within the period of a staircase time (T_{ON}) can only occur as often as the configured factor specifies. For example, the "3-fold time" setting means that after the started staircase time has elapsed and within the current retriggered time period, it is retriggered automatically a maximum of three additional times (figure 51).

- i** A time extension can generally be triggered during the entire switch-on time. In each period of an extended staircase time, new extensions can take place by telegrams. The "Maximum time extension" parameter is re-evaluated in each new time period.
- i** Telegrams for the time extension are only evaluated during the staircase time. An ON telegram during the pre-warning function or continuous lighting triggers the staircase time as a restart, which means that a new time extension is possible.

- i** If a time extension was configured as a supplementary function, the parameter "Staircase time retriggerable ?" is preset to "No" because the retriggering takes place by the time extension.

Setting supplementary function of the staircase function – time preset via the bus

With the time preset via the bus, the configured staircase time can be multiplied by an 8-bit factor received via the bus, thus it can be adapted dynamically. With this setting, the factor is derived from the object "staircase time factor". The possible factor value for setting the staircase time is between 1...255.

The entire staircase time arises as a product from factor (object value) and the configured staircase time as a basis as follows...

Staircase time = (staircase time object value) x (staircase time parameter)

Example:

Object value "staircase time factor" = 5; parameter "staircase value" = 10s.

-> set staircase time = 5 x 10s = 50 s

Alternatively, the staircase function parameter can define whether the receipt of a new factor also starts the staircase time of the staircase function at the same time. In this case, the object "Staircase function start/stop" is not necessary and the received factor value determines the starting and stopping.

- Set "supplementary function for staircase function" to "time preset via the bus" and set the parameter "staircase function activatable via 'staircase time' object ?" to "No".

The staircase time can be adapted dynamically by the "staircase time factor" object. A value "0" is interpreted as value "1". The staircase function is started and stopped exclusively via the "staircase function start / stop" object.

- Set "supplementary function for staircase function" to "time preset via the bus" and set the parameter "staircase function activatable via 'staircase time' object ?" to "Yes".

The staircase time can be adapted dynamically by the "staircase time factor" object. In addition, the staircase function is started with the new staircase time (the "staircase function start / stop" is not necessary) after receiving a new factor. A factor value "0" is interpreted as an OFF telegram, whereby in this case, the configured reaction to an OFF telegram is evaluated, too.

A larger staircase with several floors is an example as an application for the time preset via the bus with automatic starting of the staircase time. On each floor there is a push-button sensor that transmits a factor value to the staircase function. The higher the floor, the greater the factor value transmitted so that the lighting stays switched on longer if the passing through the staircase needs more time. When a person enters a staircase and a pushbutton is pressed, the staircase time is now adjusted dynamically to the staircase time and switches on the lighting at the same time, too.

- i** Setting "Staircase function activatable via "Staircase time" object ?" = "Yes":
A factor > 0 received during a warning time triggers the staircase time independently of the parameter "staircase time retriggerable ?" always afterwards.
- i** After a reset (bus voltage return or ETS programming) the "staircase time factor" object is always initialised with "1". The staircase function is not started automatically solely as the result of this, however.
- i** The two supplementary functions "time extension" and "time preset via the bus" can only be configured alternatively.

Presetting behaviour of the staircase function after bus or mains voltage return

The staircase function can be started automatically after bus or mains voltage return.

The staircase function must be enabled.

- In the parameter node "Addressing -> Groups ... -> [x] Group" or "Addressing -> Single devices ... -> [x] Electronic ballast", set the parameter "Behaviour after bus voltage return" to "Start staircase function".
Immediately after bus or mains voltage return, the staircase time of the staircase function is started.
- ❗ The configured behaviour will only be executed, if no forced position on bus voltage return is activated.

4.2.4.3.9 Operating hours counter

The operating hours counter determines the switch-on time of the DALI group or the single device. A group or an electronic ballast is actively on for the operating hours counter if the brightness value is greater than "0", i.e. when the light is lit.

The operating hours counter adds up the determined switch-on time accurately to the minute for the DALI group or the single device in full hours respectively (figure 52). The totalled operating hours are added in a 2-byte meter and stored permanently in the device. The current counter status can be transmitted cyclically to the bus by the "OHC value" communication object or when there is a change in an interval value.

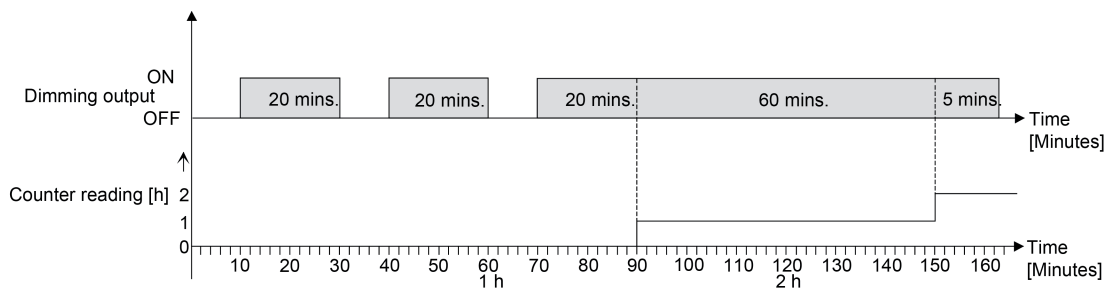

Figure 52: Function of the operating hours counter (using the example of an up-counter)

In the as-delivered state, the operating hour values of all DALI groups and single devices of the Gateway is "0". If the operating hours counter is not enabled in the configuration of a DALI group or a single device, no operating hours will be counted for the DALI group or single device concerned. Once the operating hours counter is enabled, however, the operating hours will be determined and added up by the ETS immediately after commissioning the DALI Gateway. If the operating hours counter is subsequently disabled again in the parameters and the Gateway is programmed with this disabling function, all operating hours previously counted for the DALI group or the single device concerned will be deleted. When enabled again, the meter reading of the operating hours counter is always on "0 h".

The operating hours values (full hours) stored in the device will not be lost in case of a bus/mains voltage failure or by ETS programming. Any summed up operating minutes (full hour not yet reached) will be rejected in this case, however.

After bus voltage return or after an ETS download, the Gateway passively updates the "OHC value" communication object in each DALI group or single device. The object value can be read out if the read-flag is set. The object value, depending on the configuration for the automatic transmission, is actively transmitted if necessary to the bus once the parameterised transmit delay has elapsed after bus voltage return (see page 133-134).

The operating hours counter detects any operation of the DALI groups or single devices by the manual operation, which means that switching on a channel also activates the counting of operating hours. In the same way, manual switch-off interrupts a counting operation.

Activating the operating hours counter

- Disable the "Operating hours counter" function in the parameter of the same name in the parameter node "Addressing -> Groups ... -> [x] Group -> Operating hours counter" or "Addressing -> Single devices ... -> [x] Electronic ballast -> Operating hours counter" ("yes" setting).

The operating hours counter is activated. The necessary parameters and communication objects are visible.

Deactivating the operating hours counter

- Disable the "Operating hours counter" function in the parameter of the same name in the parameter node "Addressing -> Groups ... -> [x] Group -> Operating hours counter" or "Addressing -> Single devices ... -> [x] Electronic ballast -> Operating hours counter" ("no" setting).

The operating hours counter is deactivated. No communication objects or parameters of the "Operating hours counter" function are visible.

- i Deactivation of the operating hours counter and subsequent programming with the ETS resets the counter status to "0".

Setting the counter type

The operating hours counter can optionally be configured as an up-counter or down-counter. Depending on this type of counter, a limit or start value can be set optionally, whereby, for example, the operating time of a DALI group or a single device can be monitored by restricting the counter range.

Up-counter:

After activating the operating hours counter by enabling in the ETS or by restarting, the operating hours are counted starting at "0". A maximum of 65,535 hours can be counted, after that the counter stops and signals a counter operation via the "OHC elapsed" object. A limiting value can be set optionally in the ETS or can be predefined via the communication object "OHC start/limiting value". In this case, the counter operation is signalled to the bus via the "OHC elapsed" object if the limiting value is reached. The counter continues counting - if it is not restarted - up to the maximum value 65,535 and then stops. Only a restart initiates a new counting operation.

Down-counter:

After enabling the operating hours counter in the ETS, the counter status is on "0" and the Gateway signals a counter operation for the DALI group or the single device concerned after the programming operation or after bus voltage return via the "OHC elapsed" object. Only after a restart is the down-counter set to the maximum value 65,535 the counting operation started. A starting value can be set optionally in the ETS or can be predefined via the communication object "OHC start/limiting value". If a start value is set, the down-counter is initialised with this value instead of the maximum value after a restart. The meter then counts the start value downwards by the hour. When the down-counter reaches the value "0", the counter operation is signalled to the bus via the "OHC elapsed" and the counting is stopped. Only a restart initiates a new counting operation.

Enable the "Operating hours counter" function in the parameter node "Addressing -> Groups ... -> [x] Group -> Operating hours counter" or "Addressing -> Single devices ... -> [x] Electronic ballast -> Operating hours", in order for the required communication objects and parameters to be visible.

- Set the parameter "Counter type" to "Up-counter". Set the parameter "Start/limiting value specification ?" to "yes, as received via object" or "yes, as parameter" if it is necessary to monitor the limiting value. Otherwise, reset the parameter to "no". In the "yes, as specified in parameter" setting, specify the required limit value (1...65535 hrs).
The meter counts the operating hours forwards starting from "0 h". If the monitoring of the limiting value is activated, the Gateway transmits a "1" telegram via the object "OHC elapsed" as soon as the predefined limiting value is reached. Otherwise, the counter operation is first transmitted when the maximum value 65,535 is reached.
- Set the parameter "Counter type" to "Down-counter". Set the parameter "Start/limiting value specification ?" to "yes, as received via object" or "yes, as parameter" if it is necessary to monitor the start value. Otherwise, reset the parameter to "no". In the "yes, as specified in parameter" setting, specify the required start value (1...65535 hrs.).
The meter counts the operating hours down to "0 h" after a restart. With a start value preset, the start value is counted down, otherwise the counting operation starts at the maximum value 65,535. The Gateway transmits a "1" telegram via the object "OHC elapsed" for the dimming channel concerned once the value "0" is reached.

- i** The value of the communication object "OHC elapsed" is stored permanently. The object is initialised immediately with the value that was saved before bus voltage return or ETS programming. If an operating hours counter is in this case identified as elapsed, i.e. if the object value is a "1", an additional telegram will be actively transmitted to the bus as soon as the parameterised transmit delay has elapsed after bus voltage return. If the counter has not yet elapsed (object value "0"), no telegram is transmitted on return of bus voltage or after an ETS programming operation.
- i** With a limiting or start value preset via object: The values received via the object are first validly accepted and permanently saved internally after a restart of the operating hours counter. The object is initialised immediately with the value that was last saved before bus voltage return or ETS programming. The values received will be lost in the case of a bus voltage failure or by an ETS download if no counter restart was executed before. For this reason, when specifying a new start or limiting value it is advisable to always execute a counter restart afterwards as well.
A standard value of 65,535 is predefined provided that no limiting value or start value has been received yet via the object. The values received and stored via the object are reset to the standard value if the operating hours counter is deactivated in the parameters of the ETS and an ETS programming operation is being performed.
- i** With a limiting or start value predefined via object: If the start or limiting value is predefined with "0", the actuator will ignore a counter restart to avoid an undesired reset (e.g. in site operation -> hours already counted by manual operation).
- i** If the counter direction of an operating hours counter is reversed by reconfiguration in the ETS, a restart of the meter should always be performed after programming the gateway so that the meter is reinitialised.

Restarting the operating hours counter

The counter status of the operating hours can be reset at any time by the communication object "OHC restart". The polarity of the restart telegram is predefined: "1" = restart / "0" = no reaction.

- Describe the communication object "OHC restart" as "1".

In the up-counter the meter is initialised with the value "0" after a restart and in the down-counter initialised with the start value. If no start value was configured or predefined by the object, the start value is preset to 65,535.

During every counter restart, the initialised meter reading is transmitted actively to the bus. After a restart, the signal of a counter operation is also reset. At the same time, a "0" telegram is transmitted to the bus via the object "OHC elapsed". In addition, the limiting or start value is initialised.

- i** If a new limiting or start value was predefined via the communication object, a counter restart should always be performed afterwards, too. Otherwise, the values received will be lost in the case of a bus voltage failure or by an ETS download.

- i** If the communication object "OHC start/limiting value" was described with "0" (either manually by the user or after a device reset), there are different behaviours after a restart depending on the principle of the value specification...

Preset as parameter:

The counter elapses immediately after a counter restart.

Preset via object:

A counter restart will be ignored to avoid an undesired reset (e.g. after installation of the devices with hours already being counted by manual operation). A limiting or start value greater than "0" must be predefined in order to perform the restart.

Setting the transmission behaviour

The current value of the operating hours counter is always tracked in the communication object "OHC value". After bus voltage return or after an ETS programming operation, the Gateway passively updates the "OHC value" communication object in each DALI group or single device.

The object value can be read out if the read-flag is set.

In addition, the transmission behaviour of this communication object can be set.

Enable the "Operating hours counter" function in the parameter node "Addressing -> Groups ... -> [x] Group -> Operating hours counter" or "Addressing -> Single devices ... -> [x] Electronic ballast -> Operating hours", in order for the required communication objects and parameters to be visible.

- Set the parameter "Automatic transmission of counting value" to "After change by interval value". Configure the "Counting value interval (1...65535 hrs.)" to the desired value.

The meter reading is transmitted to the bus as soon as it changes by the predefined counting value interval. After bus voltage return or after ETS programming operation, the object value is transmitted automatically after "Delay after bus voltage return" has elapsed if the current counter status or a multiple of this corresponds to the counting value interval. A counter status "0" is always transmitted in this case.

- Set the parameter "Automatic transmission of counting value" to "Cyclical".

The counter value is transmitted cyclically. The cycle time is defined independent of the channel on the parameter page "Status and feedback". After bus voltage return or ETS programming, the counter status is transmitted to the KNX after the configured cycle time has elapsed.

4.2.4.4 Scene function

The DALI Gateway allows the creation of up to 16 of your own scenes. Each individual scene can be assigned to the available DALI groups or single devices. Furthermore, a scene brightness value as well as a colour temperature, if used, can be configured for each assigned group and each assigned single device and stored in the DALI Gateway. This also allows the integration of various operating devices into scene controls.

If necessary, the individual scenes must be created in the "Scenes" parameter node. Scenes can be created by selecting the "Scenes" node in the tree view and then executing the command **New** using the context menu (right mouse-click).

Selecting a created scene in the tree view causes the scene configuration to appear in the right pane of the plug-in.(figure 53).

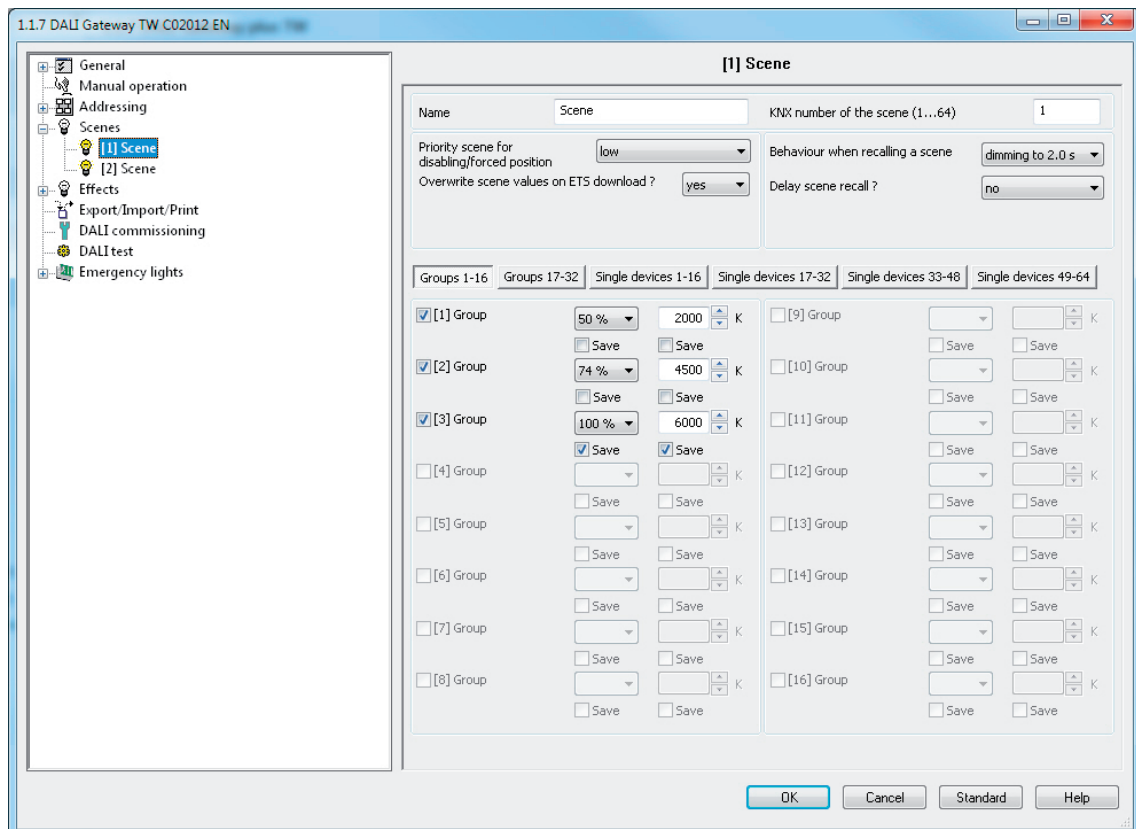

Figure 53: Configuration page of a scene as an example with two created effect scenes and three DALI groups

Created scenes can also be copied using the **Copy** command of the context menu of an appropriate scene parameter node and inserted into the higher-level nodes "Scenes" as a new scene using **Insert**. Parameter settings are also applied. It is also possible to insert a previously copied scene into an existing scene. All the parameter settings are applied without creating a new element.

Created scenes can be deleted at any time by selecting the appropriate parameter node in the tree structure and executing the **Delete** command of the context menu. In addition, a parameter can be used to assign a name to each scene. It is possible to change a name at a later date using the parameter configuration or, alternatively, by using the **Rename** command in the context menu. We recommend labelling each scene clearly by giving it a name (e.g. "Scene TV", "Scene dining", etc.). The name may be a maximum of 28 characters and may contain alphanumeric and special characters.

Each scene receives a unique number (1...16), which is shown in square brackets before the name. This number is only a label within the ETS plug-in, in order to distinguish clearly between the individual scenes, even if they have the same name. In addition, scenes have KNX numbers (1...64). These KNX numbers can be used to recall a scene or a scene memory function using

the scene extension object. Scene numbers do not have to be identical to KNX extension numbers. The KNX numbers are configured individually. KNX numbers must be unique. It is not possible to assign the same KNX numbers to multiple scenes.

A scene recall overrides a brightness value specification via the "Brightness value" object, a switching or dimming operation via the objects "Switching", "Central function switching" and "Dimming" as well as specifications for colour temperatures via the object "Absolute colour temperature (K)". A staircase function is also overridden by a scene recall. The priority of the scene function over the disabling or forced position functions of a group or a single device can be configured for each scene. Thus, it is possible for a scene recall to override a disabling or forced position function. Alternatively, a scene can have a lower priority, which means that disabling functions or forced positions cannot be overridden by a scene recall. A function overridden by a scene recall is executed again when the function is updated via the KNX. A scene recall can optionally take place after a delay.

Setting a KNX scene number

Scenes possess KNX numbers (1...64). These KNX numbers can be used to recall a scene or a scene memory function using the scene extension object. The KNX numbers are configured individually for each scene. KNX numbers must be unique. It is not possible to assign the same KNX numbers to multiple scenes.

- In the parameter node "Scenes -> [x] Scene name" in the parameter "KNX number of the scene (1...64)", set the required extension number.

It is possible to recall and save a scene via the scene extension object using the specified KNX number.

- i** If a KNX number already used for another scene is entered, the ETS plug-in will then automatically correct the input value to the next free KNX number.
- i** It should be noted that the object value of the extension input is always "1" less than the configured KNX number, in accordance with KNX DPT 18.001.
Example: KNX number = "1" -> Value in extension object = "0" -> The value "0" recalls the scene with the KNX number 1. The value "1" recalls the scene with the KNX number 2.
This applies appropriately for all other scenes and KNX numbers.

Configuring the group and device assignment of a scene

Groups and single devices can be assigned to a scene without restrictions. Each group and each single device can be assigned independently by activating the checkbox in front of the group or single device name in the scene configuration.(figure 54). Groups and single devices, whose checkboxes are not activated, are not assigned to the scene. Any non-created groups or single devices of the DALI Gateway are greyed out and thus cannot be edited.

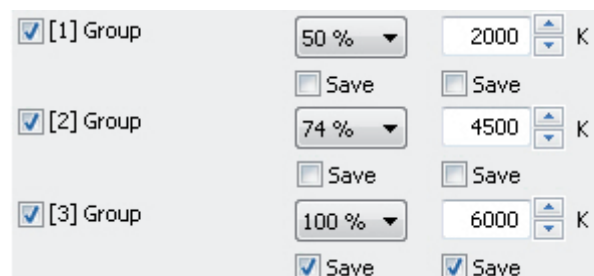

Figure 54: Example of a group assignment to a scene with brightness values and colour temperature values

For reasons of clarity, all the available groups (1...32) and single devices (1...64) - irrespective of the configured addressing type - are split up into various pages in the scene function window, each of which can be displayed separately. 16 groups or single devices are available on any given page. Pressing the buttons "Groups...", "Single devices..." in the scene configuration window changes between the page views.

Scenes can also be used for a master control (broadcast). Only one brightness value and optionally one colour temperature value can ever be assigned to each scene.

- Activate the checkbox of the DALI groups and single devices, which are to be assigned to the selected scene.

The activated groups and single devices are assigned to the scene. The parameters of the scene brightness value and - if the colour temperature control is used - scene colour temperature value are enabled including the parameter for the memory functions.

- i** DALI groups or single devices integrated in centrally supplied emergency lighting operation cannot be assigned to any scene! Assignments to scenes are lost if the integration of groups or devices takes place later in emergency operation. In these cases, the ETS plug-in warns of losing assignments.

Setting scene brightness values and colour temperature values

For each DALI group integrated in a scene, for each integrated single device and for each scene, it is necessary to specify which brightness value is to be set when a scene is recalled. When using the tunable white function for DALI operating devices, which support the "Colour Control" (DALI Device Type 8) device type, a colour temperature can also optionally be defined for each assigned group or single device.

A group or a single device must be assigned to a scene.

- In the parameter node "Scenes -> [x] Scene name", specify the necessary scene brightness value for each DALI group assigned to the scene and each assigned single device.

During a scene recall, the appropriate configured brightness value is set on the operating devices. In the setting "---" the brightness value of the group or single device remains unchanged when recalling the scene.

- When using the colour temperature control: In the parameter node "Scenes -> [x] Scene name", specify the necessary scene colour temperature value for each DALI group assigned to the scene and each assigned single device. In the setting "---" the colour temperature value of the group or single device remains unchanged when recalling the scene.

During a scene recall, the appropriate configured colour temperature is set on the operating devices. It should be noted that a colour temperature specified in the scene is only visually effective in the DALI lights if the group or single device is switched on, too.

Even if groups or single devices are switched off, colour temperature changes are tracked internally in the device when recalling a scene. On switching on a group or single device after a scene recall, the colour temperature most recently recalled according to the scene is preset in the DALI lights.

- i** The configured brightness values and colour temperature values are adopted in the DALI Gateway during programming with the ETS only if the parameter "Overwrite scene values during ETS download ?" is set to "yes".
- i** The selection of the scene brightness value and scene colour temperature value is restricted in the ETS plug-in by the configured minimum and maximum values.
- i** The parameters for the colour temperature are only available if the tunable white lights are integrated under "General". If the colour temperature control is used globally, the plug-in always displays parameters for the colour temperature for all groups and single devices in all scenes, too. This is displayed even if no colour temperature control at all is provided in the groups or single devices (e.g. in the case of DALI device types that do not even allow any colour temperature control). In such cases, the colour temperature specifications in the scenes are ineffective.

- i** During DALI commissioning, it is possible to assign multiple identical DALI operating devices to different groups (multiple assignment: e.g. Electronic ballast 1 is located in Group A and Group B). If groups (e.g. A & B) have now been assigned to a scene and these groups contain the same operating devices (e.g. electronic ballast 1), then there will be a conflict on account of the differing scene brightness values or scene colour temperature values. In this case, the operating devices assigned multiple times are set to the value of the group with the highest number.

Presetting the storage behaviour for the scene function

The current brightness values of all the DALI groups and single devices assigned to a scene can be saved using the scene extension using when a save telegram is received. In so doing, the brightness values to be saved can be influenced by all the functions of the individual groups and devices (e.g. switching, dimming, manual operation) before saving. When using the tunable white function for DALI operating devices, which support the "Colour Control" (DALI Device Type 8) device type, the memory function of the colour temperature can also optionally be triggered for each assigned group or single device.

A group or a single device must be assigned to a scene.

- In the parameter node "Scenes -> [x] Scene name" activate the "Save" checkbox for the DALI groups and single devices below the brightness value, which are to react to the memory function.

The memory function of the brightness is activated for the DALI group or single device affected. The current brightness value is stored internally in the scene via the extension object on receipt of a storage telegram.

- In the parameter node "Scenes -> [x] Scene name" activate the "Save" checkbox for the DALI groups and single devices below the colour temperature value, which are to react to the memory function.

The memory function of the colour temperature is activated for the DALI group or single device affected. The current colour temperature is stored internally in the scene via the extension object on receipt of a storage telegram.

- In the parameter node "Scenes -> [x] Scene name" deactivate the "Save" checkbox for the DALI groups and single devices below the brightness value, which are not to react to the memory function.

The memory function of the brightness is deactivated for the DALI group or single device affected. A storage telegram received via the extension object will be rejected based on the brightness. During a scene recall, the brightness permanently defined in the scene is then recalled.

- In the parameter node "Scenes -> [x] Scene name" deactivate the "Save" checkbox for the DALI groups and single devices below the colour temperature value, which are not to react to the memory function.

The memory function of the colour temperature is deactivated for the DALI group or single device affected. A storage telegram received via the extension object will be rejected based on the colour temperature. During a scene recall, the colour temperature permanently defined in the scene is then recalled.

- i** If the brightness or colour temperature of a scene is configured to "---" (no change), the memory function of the scene values concerned can generally not be executed. The checkbox of the memory function is then not selectable in the ETS plug-in.

- i** During a save operation, scene values are saved to internal non-volatile memory in the DALI Gateway, thus overwriting the value of a group or single device most recently programmed by the ETS. The configured brightness values and colour temperature values in the ETS are adopted again in the DALI Gateway during programming with the ETS only if the parameter "Overwrite scene values during ETS download ?" is set to "yes".

- i** Irrespective of the set priority for the entire scene, no new scene values are ever saved if disabling or a forced position is active for individual groups or devices.

Setting the scene priority

The priority of the scene function over the disabling or forced position functions of a group or a single device can be configured for each scene. Thus, it is possible for a scene recall to override a disabling or forced position function. Alternatively, a scene can have a lower priority, which means that disabling functions or forced positions cannot be overridden by a scene recall. The scene priority can be configured separately for each created scene.

- In the parameter node "Scenes -> [x] Scene name", configure the parameter "Priority, scene to be disabled/forced position" to "low".

The scene has a lower priority to the supplementary functions of the assigned groups or the assigned single devices. It is not possible to call up or save a scene if a supplementary function is only activated for one group or one single device.

- In the parameter node "Scenes -> [x] Scene name", configure the parameter "Priority, scene to be disabled/forced position" to "high".

The scene has a higher priority to the supplementary functions of the assigned groups or the assigned single devices. Scenes are only ever called-up or saved when a scene extension unit is received.

- i** Irrespective of the set priority for the entire scene, no new scene values are ever saved if disabling or a forced position is active for individual groups or devices.
- i** In the "Tracked brightness value" setting at the end of disabling/forced position: At the end of the supplementary functions, a scene recall received during the function will not be tracked.
- i** In the "Priority = High" setting: A scene recall does not statically lock the lower-level functions of a group or a single device. The higher priority solely specifies that the scene brightness value is set at the moment of the scene recall and the previously specified brightness value is overridden. After scene recall, it is possible that the scene brightness value will be changed by other functions of the Gateway (e.g. on terminating an additional function or by switching or dimming).
- i** Scenes can also be included in effect steps. In this case, the scene priority is not evaluated when an effect is recalled. The configured priority of the appropriate effect is of more importance.

Setting the ETS programming behaviour for the scene function

During storage of a scene, the scene values are stored internally to non-volatile memory in the device. To prevent the stored values from being replaced during ETS programming of the application or of the parameters by the originally programmed scene brightness values or scene colour temperature values, the DALI Gateway can inhibit overwriting of the scene values. As an alternative, the original values can be reloaded into the device during each programming run of the ETS.

The ETS programming behaviour can be configured separately for each scene.

- In the parameter node "Scenes -> [x] Scene name", set the parameter "Overwrite scene values during ETS download" to "yes".

During each ETS programming operation of the application program or of the parameters, the scene values configured in the ETS will be programmed into the Gateway. Scene values stored in the device by means of a storage function will be overwritten, if any.

- In the parameter node "Scenes -> [x] Scene name", set the parameter "Overwrite scene values during ETS download" to "no".

Scene values stored in the device with a storage function will be maintained. If no scene values have been stored, the brightness values and colour temperature values last programmed in the ETS remain valid.

- i** During first commissioning of the Gateway, this parameter should be set to "yes" so that the scenes are initialised with valid scene values.

Presetting the recall delay for the scene function

Each scene recall can optionally also be evaluated after a delay. With this feature, dynamical scene sequences can, for example, be configured if several actuators or Gateways are combined with cyclical scene telegrams.

The scene recall delay can be configured separately for each created scene.

- In the parameter node "Scenes -> [x] Scene name", set the parameter "Delay scene recall?" to "yes". Configure the delay time.

The delay time is activated. The delay only influences the scene recall of the appropriate scene. The delay time is started on arrival of a recall telegram. The corresponding scene will be recalled and the brightness and colour temperature value set to the respective scene position value only after this time has elapsed.

- In the parameter node "Scenes -> [x] Scene name", set the parameter "Delay scene recall?" to "no".

The delay time is deactivated. A scene recall is carried out without a delay immediately after the receipt of a scene recall telegram.

- i** Each scene recall telegram restarts the delay time and retriggers it. If a new scene recall telegram is received while a delay is active (scene recall not yet executed), the old (and not yet recalled scene) will be rejected and only the scene last received executed.
- i** The scene recall delay has no influence on the storage of scene values. A scene storage telegram within a scene recall delay terminates the delay and thus the scene recall.
- i** In case of bus or mains voltage failure, all time functions will be stopped. Therefore, all scene recalls that are still in the delay stage will be aborted. A scene recall received shortly before bus or mains voltage failure will then be lost if the corresponding delay has not yet elapsed. A delayed scene recall will also be completely aborted for the affected groups or single devices in the case of a function with a higher priority (e.g. manual operation, forced position function, disable function).
- i** Scenes can also be included in effect steps. In this case, the recall delay set for the scene is not effective when an effect is recalled. The configured time sequence of the effect is of more importance.

Setting the dimming behaviour when recalling a scene

In the scene configuration, it is possible to define whether the scene brightness values and scene colour temperature values for the assigned groups or single devices jump instantly or dim. A scene recall can therefore be executed independently of the set dimming behaviour. The behaviour during a scene recall can be configured separately for each scene.

- In the parameter node "Scenes -> [x] Scene name", set the parameter "Behaviour on scene recall" to "Jump".

The values of the scene concerned are jumped to instantly during a recall.

- In the parameter node "Scenes -> [x] Scene name", set the parameter "Behaviour on scene recall" to "Dim to...". "Dim to...". At the same time, define the time required to dim to the scene values.

The values of the scene concerned are dimmed to during a recall. The dim fading is activated. The time in the parameter selection defines the duration of the dimming procedure required to reach the values. The brightness values and colour temperature values of a group or a single device at which the dimming starts has no significance. Thus, the dimming procedure in case of a scene recall always requires the exact predefined time for all groups and single devices of the scene.

- i** Any DALI operating devices included in the scene (through groups or as a single device) react simultaneously, because addressing takes place on the DALI-side using scene commands (Multicast), which the Gateway programs into the operating device during initialisation, according to the scene configuration in the ETS plug-in.
- i** The configured dimming time for the dim fading of the scene function may deviate from the standard dimming behaviour of a group or a single device. The DALI Gateway always works with a standard fading time of 0.7 seconds. This value is automatically programmed into DALI operating devices during initialisation. Directly after scene recall, the Gateway reprograms all the assigned DALI operating devices to the dimming time of the scene. After recalling the scene, the Gateway immediately reprograms the fading time back to the original value. This reprogramming takes place separately for each group and single device integrated into the scene in sequence via the DALI cable.
- i** Scenes can also be included in effect steps. In this case, the dimming behaviour set for the scene is not effective when an effect is recalled. The configured dimming behaviour of an effect is of more importance.

4.2.4.5 Effect function

In particular, for the implementation of dynamic light scenes, it is possible to include lights or light groups in the effect control of the DALI Gateway. Up to 16 effects are available here, each with up to 16 effect steps. Each effect step represents an individual light scene. Time-controlled toggling of the effect steps makes the overall effect dynamic. Brightness and colour temperature sequences (colour temperature only with DALI operating devices that support device type "Colour Control" (DALI Device Type 8)) can be implemented using one or more DALI groups, as well as using individual DALI devices or scenes.

Effects are created in the ETS plug-in and are configured separately. An effect can be added to the configuration by selecting the parameter node "Effects" in the tree view and then executing the command **New** using the context menu (right mouse-click).

Selecting a created effect in the tree view causes the effect configuration to appear in the right pane of the plug-in.(figure 55).

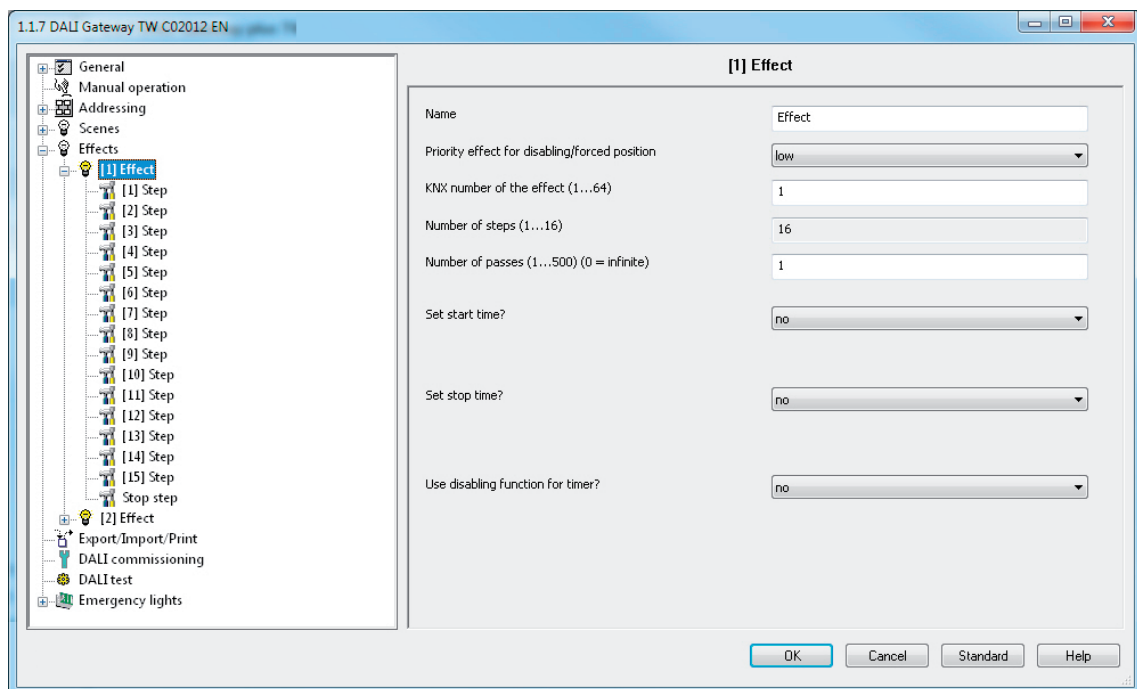

Figure 55: Configuration page of an effect as an example with 15 created effect steps and stop step

Editing effects

Up to 15 effect steps can be created for each effect, as necessary. The last step of an effect is always the stop step in the configuration. This is only executed when the effect is stopped automatically after the number of run-throughs (ETS parameter) has been reached, or the user performs the Stop command via communication objects. A new effect step can be added by selecting an effect parameter node in the tree view and then executing the **New** command in the context menu. This always adds the first step of an effect. If steps already exist, these are always shifted one place when new steps are added. The existing steps are thus given a new, higher step number (2...15).

- i** When new effects are created, all the necessary effect steps should always be created directly, in order to avoid subsequent editing and shifting of the effect sequences due to the adding of new steps.

Created effects can also be copied using the **Copy** command of the context menu of an appropriate scene or effect parameter node and inserted into the higher-level node "Effects" as a new effect using **Insert**. Parameter settings are also applied. It is also possible to insert a

previously copied effect into an existing effect. All the parameter settings are applied without creating a new element.

Effect steps can only be copied and inserted into existing steps. This completely transfers the configuration of the copied step into another step. This function can be used, for example, to transport existing step configurations into other steps, after new steps have been added, thereby changing the sequence of the light scene.

Created effects and effect steps can be deleted at any time by selecting the appropriate parameter node in the tree structure and executing the **Delete** command of the context menu. In addition, a parameter can be used to assign a name to each effect. It is possible to change a name at a later date using the parameter configuration or, alternatively, by using the **Rename** command in the context menu. We recommend labelling each effect clearly by giving it a name (e.g. "Effect window", "Effect entrance area", etc.). The name may be a maximum of 28 characters and may contain alphanumeric and special characters.

Each effect receives a unique number (1...16), which is shown in square brackets before the name. This number is only a label within the ETS plug-in, in order to distinguish clearly between the individual effects, even if they have the same name. In addition, effects possess KNX numbers (1...64). These KNX numbers can be used to start and stop the effects using the extension object. Effect numbers do not have to be identical to KNX extension numbers. The KNX numbers are configured individually.

KNX numbers must be unique. It is not possible to assign the same KNX numbers to multiple effects.

In the case of effect steps, the step number (1...15) is displayed in square brackets. This labels the step sequence of an effect run-through directly.

Starting and stopping effects (effect run-through)

Effect steps can control DALI groups, single devices and scenes. As soon as it is started, an effect runs "in the background". Each new effect step overrides the previous effect step or the most recently specified brightness and colour temperature state of an integrated DALI group or an assigned single device. In contrast to the control of groups and devices via the objects "Switching", "Dimming", "Brightness value", "Absolute colour temperature" and "Central function for groups and devices", effects always have the same priority. The last presetting determines the brightness and colour temperature value.

With regard to the time sequences (time between effect steps, dimming behaviour), an effect only ever works with the parameters of the effect steps. Parameters of the DALI groups, individual devices or the scenes are irrelevant for the effect function. To ensure that time functions of the groups and devices (e.g. staircase function, time delays) and the effect function do not influence each other, parallel operation of these functions, i.e. the execution of an effect and control using group or device functions, should be avoided if possible.

An effect always starts at effect step 1. The steps are processed in sequence, according to their number. Once all the brightness values and colour temperature values of an effect step have been set, the effect controller waits for the set "Delay until the next step". Then the next step is recalled. An effect run-through corresponds to calling up all the steps created in the effect. The number of run-throughs can be specified individually between 1...500 using a parameter. An effect stops automatically when the configured number of run-throughs has been reached. Otherwise the effect starts again with the first step after processing of the last effect step. Alternatively, an effect can also be started manually using communication objects and stopped at any time. A stop command terminates the effect immediately after the processing of the current step and subsequent execution of the stop step, without recalling other effect steps or waiting for delay times (figure 57). There are separate 1-bit objects (1 = Start effect / 0 = Stop effect) as well as a shared 1-byte extension object available manual starting and stopping of effects.

When an effect is stopped, the stop step is always executed. This makes it possible to set a defined lighting state. The stop step is not executed explicitly between multiple effect run-throughs.

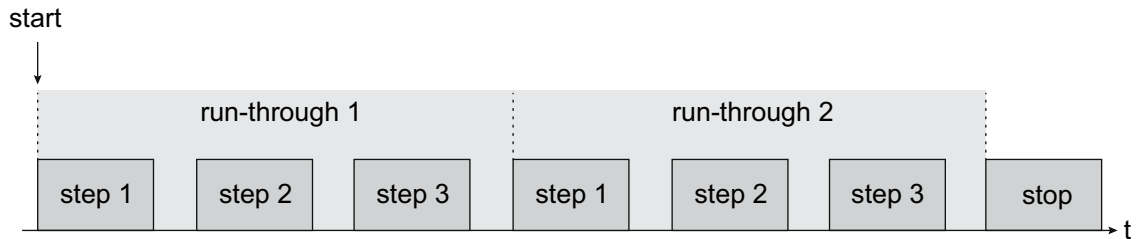

Figure 56: Example of an effect sequence with automatic stop (here: 3 effect steps, 2 run-throughs)

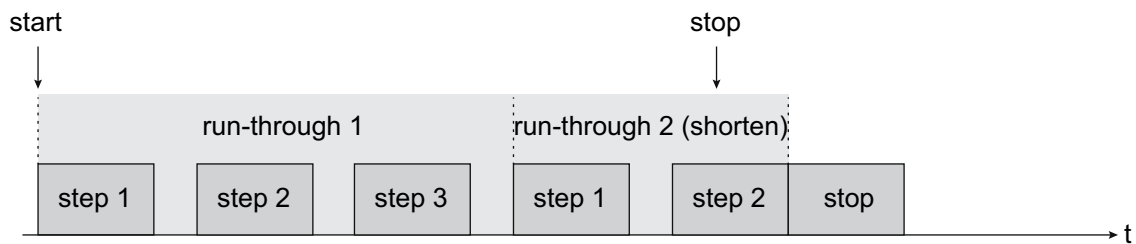

Figure 57: Example of an effect sequence with manual stop (here: 3 effect steps, run-through 2 is stopped early)

- i** Retriggering of an effect (multiple starting) shows no reaction. The effect continues normally. An effect must first be stopped, in order to restart it in a defined manner at Step 1.
- i** It is possible to run through multiple effects simultaneously. If the same groups, single devices or scenes are integrated into effects running simultaneously, then the effects influence each other. In order to achieve a tidy, fault-free effect run-through, always try to avoid running through effects with the same assignments simultaneously.

The priority of the effect function over the disabling or forced position functions of a group or a single device can be configured separately for each effect. Thus, it is possible for an effect recall to override a disabling or forced position function. An effect can have a lower priority, meaning that disabling functions or forced positions cannot be overridden by a effect recall.

Setting a KNX effect number

Just like scenes, effects possess KNX numbers (1...64). These KNX numbers can be used to start and also stop individual effects using the extension object of the effect function. The KNX numbers are configured individually for each effect. KNX numbers must be unique. It is not possible to assign the same KNX numbers to multiple effects.

The structure of the telegram value for the effect extension is orientated to the KNX DPT 18.001, which is also used in the scene extension (figure 58).

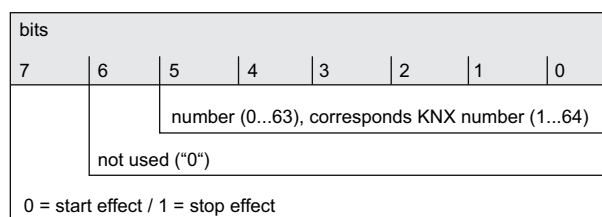

Figure 58: Structure of the object value for the effect extension

- In the parameter node "Effects - [x] Effect name" in the parameter "KNX number of the effect (1...64)", set the required extension number.
It is possible to start and stop an effect via the effect extension object using the specified KNX number.
- ❗ If a KNX number already used for another effect is entered, then the ETS plug-in will automatically correct the input value to the next free KNX number.
- ❗ It should be noted that the object value of the extension input is always "1" less than the configured KNX number, in accordance with KNX DPT 18.001 (figure 58).
Example: KNX number = "1" -> Value in extension object = "0" -> The value "0" recalls the effect with the KNX number 1. The value "1" starts the effect with the KNX number 2. This applies appropriately for all other effects and KNX numbers.

Setting the effect priority

The priority of the individual effects over the disabling or forced position functions of a group or a single device can be configured for each scene. Thus, it is possible for an effect to override a disabling or forced position function. An effect can have a lower priority, meaning that disabling functions or forced positions cannot be overridden by a effect recall.

- In the parameter node "Effects -> [x] Effect name", configure the parameter "Priority, effect to be disabled/forced position" to "Low".
The effect has a lower priority to the supplementary functions of the assigned groups or the assigned single devices. It is not possible to start an effect if a supplementary functions is only activated for one group or one single device (if assigned).
- In the parameter node "Effects -> [x] Effect name", configure the parameter "Priority, effect to be disabled/forced position" to "High".
The effect has a higher priority to the supplementary functions of the assigned groups or the assigned single devices. The effect can be started if a disabling or forced position function is active.
- ❗ Note that the effect priority set in the ETS plug-in is only observed when an effect is to be restarted. Priority is ignored - irrespective of the setting- if a previously started effect is running and a disabling or forced position is activated. For this reason, an effect with a higher priority, if it is running, can be overridden with a disabling or forced position function. In the same way, a disabling or forced position function with a higher priority can be overridden by an effect, if the activation of the disabling or the forced position takes place after the effect starts.
- ❗ If scenes are integrated in an effect step, then the scene priority is not evaluated when an effect is recalled. The configured priority of the appropriate effect is of more importance.

Setting the number of effect run-throughs

An effect always starts at effect step 1. The steps are processed in sequence, according to their number. An effect run-through corresponds to calling up all the steps created in the effect. The number of run-throughs can be specified individually between 1...500 using a parameter. An

effect stops automatically when the configured number of run-throughs has been reached. Otherwise the effect starts again with the first step after processing of the last effect step.

- In the parameter node "Effects -> [x] Effect name", set the parameter "Number of run-throughs" to the desired value (0...500).

The effect repeats the set number of times. Then the effect stops automatically. In the "0" setting, the effect repeats cyclically, until a manual Stop command is received via the communication objects.

- i** A manual stop command via the communication objects terminates the effect immediately after the processing of the current step and subsequent execution of the stop step, without recalling other effect steps or waiting for delay times.

Configuring the group and device assignment of an effect step

Groups and single devices can be assigned to an effect step without restrictions. In addition, it is possible to assign created scenes. Each group, each single device and each scene can be assigned independently by activating the checkbox in front of the group or single device name or the scene name in the configuration of the effect steps.(figure 59). Groups, single devices and scenes, whose checkboxes are not activated, are not assigned to the effect step. Any non-created groups, single devices or scenes of the DALI Gateway are greyed out and thus cannot be edited.

<input checked="" type="checkbox"/> [1] Group	50 %	2000	K
<input checked="" type="checkbox"/> [2] Group	74 %	4000	K
<input checked="" type="checkbox"/> [3] Group	100 %	6000	K
<input type="checkbox"/> [4] Group			K

Figure 59: Example of a group assignment to an effect step

For reasons of clarity, all the available groups (1...32) and single devices (1...64) - irrespective of the configured addressing type - as well as the scenes (1...16) are split up into various pages in the window of an effect step, each of which can be displayed separately. 16 groups or single devices are available on any given page. Scenes also have their own page. Pressing the buttons "Groups...", "Single devices..." or "Scenes 1-16" in the configuration window of an effect step changes between the page views.

Effects can also be used for master control (broadcast). Only one brightness value and one colour temperature value is ever assigned to each effect step.

- Activate the checkbox of the DALI groups, single devices and scenes, which are to be assigned to the selected effect step.

The activated groups, single devices and scenes are assigned to the effect step. The parameters of the brightness values and - if the colour temperature control is used - colour temperature values are enabled.

- i** Assigned single devices are contacted in turn by the effect controller, because the devices are addressed individually using their short address. This slows down processing of an effect step. In addition, this influences the processing time of an effect step, if the dimming behaviour allows for dimming times other than the standard (0.7 seconds). The more groups or single devices are assigned to an effect step, the slower the effect step editing will be. The "Delay until next step" is only started when the last assignment of an effect step has been processed.
When a scene is recalled, the slowing effect from the addressing type does not noticeably occur. For this reason, we recommend integrating devices - if at all possible - into scenes and assigning them to the effect controller.
Only groups, single devices or scenes, whose brightness or colour temperature are to be changed by an effect step, should ever be assigned to that step.
- i** If several identical DALI operating devices are integrated into an effect step, for example, due to redundant integration via groups and scenes, the brightness and colour temperature commands are evaluated and set using a fixed priority. The group brightness/colour temperature value specified in an effect step has the highest priority and thus prevails over values of single devices and scenes. The brightness/colour temperature values of single devices have medium priority and prevail over scene values. Scene values have the lowest priority.
- i** It is possible to run through multiple effects simultaneously. If the same groups, single devices or scenes are integrated into effects running simultaneously, then the effects influence each other. In order to achieve a tidy, fault-free effect run-through, always try to avoid running through effects with the same assignments simultaneously.
- i** DALI groups or single devices integrated in centrally supplied emergency lighting operation cannot be used in effects! Assignments to effect steps are lost if the integration of groups or devices takes place later in emergency operation. In these cases, the ETS plug-in warns of losing assignments.

Setting brightness values and colour temperatures for effect steps

For each DALI group integrated in an effect step and for each integrated single device, it is necessary to specify which brightness value is to be set when the effect step is recalled. When using the tunable white function for DALI operating devices, which support the "Colour Control" (DALI Device Type 8) device type, a colour temperature can also optionally be defined for each assigned group or single device.

A group, a single device or a scene must be assigned to an effect step.

- In the parameter node "Effects -> [x] Effect name -> [y] Step" (x = 1...16 / y = 1...15), specify the necessary brightness value for each assigned DALI group and for each assigned single device. In the setting "---" the brightness value of the group or single device remains unchanged when recalling the effect step.

During a recall of the effect step, the appropriate configured brightness value is set on the operating devices.

- When using the colour temperature control: In the parameter node "effect -> [x] effect name -> [y] step" (x = 1...16 / y = 1...15), specify the necessary scene colour temperature value for each DALI group assigned to the scene and for each assigned single device. In the setting "---" the colour temperature of the group or single device remains unchanged when recalling the effect step.

During a recall of the effect step, the appropriate configured colour temperature is set on the operating devices. It should be noted that a specified colour temperature is only visually effective in the DALI lights if the group or single device is switched on, too.

Even if groups or single devices are switched off, colour temperature changes are tracked internally in the device during the effect control. On switching on a group or single device while an effect is running, the colour temperature most recently recalled according to the current effect step is preset in the DALI lights.

- i** The selection of the brightness values and colour temperature values is restricted in the ETS plug-in by the configured minimum and maximum values.

- i** The parameters for the colour temperature are only available if the tunable white lights are integrated under "General". If the colour temperature control is used globally, the plug-in always displays parameters for the colour temperature for all groups and single devices in all effect steps, too. This is displayed even if no colour temperature control at all is provided in the groups or single devices (e.g. in the case of DALI device types that do not even allow any colour temperature control). In such cases, the colour temperature specifications in the effect steps are ineffective.
- i** During DALI commissioning, it is possible to assign multiple identical DALI operating devices to different groups (multiple assignment: e.g. Electronic ballast 1 is located in Group A and Group B). If groups (e.g. A & B) have now been assigned to an effect step and these groups contains the same operating devices (e.g. electronic ballast 1), then there will be a conflict on account of the differing effect step brightness values. In this case, the effect controller calls up all the brightness values in order (starting with Group 1). If there is a multiple assignment of electronic ballasts, it may occur that brief brightness changes occur (e.g. brightness jumps, flickering, etc.) when an effect step is recalled. The same applies to scenes in an effect step, if various scene assignments are configured with identical groups.

Setting the dimming behaviour when recalling effect steps

In the configuration of an effect step, it is possible to specify whether the brightness values and colour temperature values for the assigned groups, single devices or scenes are recalled with an instant jump or are dimmed to. The recall of an effect step can thus be executed independently of the set dimming behaviour of the groups or single devices.

- In the parameter node "Effects -> [x] Effect name -> [y] Step" (x = 1...16 / y = 1...15), set the parameter "Behaviour on recalling the effect step" to "Jump to".
The values of the effect step affected are jumped to during a recall.
- In the parameter node "Effects -> [x] Effect name -> [y] Step" (x = 1...16 / y = 1...15), set the parameter "Behaviour on recalling the effect step" to "Dim to...". At the same time, define the time required to dim to the values.

The values of the effect step affected are dimmed to during a recall. The dim fading is activated. The time in the parameter selection defines the duration of the dimming procedure required to reach the values. The brightness values and colour temperature values of a group or a single device at which the dimming starts has no significance. Thus, the dimming procedure in case of an effect recall always requires the exact predefined time for all groups, single devices and scenes.

- i** The configured dimming time for the dim fading of the effect function may deviate from the standard dimming behaviour of a group or a single device. The DALI Gateway always works with a standard fading time of 0.7 seconds. This value is automatically programmed into DALI operating devices during initialisation. If the dimming behaviour of an effect step now allows for another fading time, the Gateway will reprogram all the assigned DALI operating devices to the dimming time of the effect step directly after recall. After the configured brightness/colour temperature value has been specified, the Gateway immediately reprograms the fading time back to the original value. This reprogramming takes place separately for each group, each single device and each scene integrated into the effect step in sequence via the DALI cable. As a result, the processing of an effect step becomes longer, the more groups, single devices or scenes are assigned to it. The "Delay until next step" is only started when the last assignment of an effect step has been processed.
- i** If scenes are integrated in an effect step, the dimming behaviour set for the scene is not effective when an effect is recalled. The configured dimming behaviour of an effect is of more importance.

Setting a delay between effect steps

During an effect run-through, effect steps are processed in sequence, according to their number. Once all the brightness values and colour temperature values of an effect step have been set, the effect controller waits for the set "Delay until the next step". Then the next step is recalled.

- In the parameter node "Effects -> [x] Effect name -> [y] Step" (x = 1...16 / y = 1...15), configure the parameter "Delay until next step" to the required time.

When an effect step is recalled, the effect controller sets all the values according to the presetting and then waits for the set time. Only then is the next step recalled. In the "00:00.0" setting, the individual steps are recalled without delay after their processing.

- i Assigned single devices are contacted in turn by the effect controller, because the devices are addressed individually using their short address. This slows down processing of an effect step. In addition, this influences the processing time of an effect step, if the dimming behaviour allows for dimming times other than the standard (0.7 seconds). The more groups or single devices are assigned to an effect step, the slower the effect step editing will be. The "Delay until next step" is only started when the last assignment of an effect step has been processed.

Timer for effects

Effects can start and stop automatically depending on the time and weekday if necessary. This function is implemented by a simple timer. If the timer function is to be used, this must be enabled globally.

- In the parameter node "Effects" configure the parameter "Start effects by timer?" to "yes (start by timer or object)".

The timer function is enabled globally. Effects can be assigned to the particular parameter pages of the timer function by configuring start and stop times. In addition to controlling via the timer, effects can always be started and stopped as well via the communication objects (1-bit or 1-byte extension) or DALI test function.

- Configure the parameter "Start effects by timer?" to "no (start only by object)".

The timer function is not available. Effects can be started and stopped exclusively via the communication objects (1-bit or 1-byte extension) or via the DALI test function.

- i Starting and stopping via the timer is equivalent to controlling via the communication objects. An effect started by the timer can be stopped by a KNX command on the objects at any time. Similarly, it is possible to stop an effect started via the objects using the timer.

To ensure that the timer can process the configured start and stop times, the current time and current weekday must be transmitted to the Gateway via the KNX. The data format for providing this information can be set in the ETS plug-in.

The timer function must be enabled globally.

- Set the parameter "Data format for time and date of the timer" to "3-byte 'weekday / time' (DPT 10.001)".

The current time and weekday for the timer is provided by a 3-byte object according to KNX DPT 10.001.

- Configure the parameter "Data format for time and date of the timer" to "8-byte 'date / weekday / time' (DPT 19.001)".

The current time and weekday for the timer is provided by an 8-byte object according to KNX DPT 19.001. The date contained in the telegram is irrelevant and is rejected by the timer.

- i** The data format for transmitting the time and weekday makes it possible not to specify any weekday in the telegram either (telegram value for the weekday = 0 / "any day"). In this case, the Gateway evaluates all start and stop times cyclically each day regardless of which weekdays were specified in the ETS configuration! The Gateway first then evaluates the configured weekdays again as soon as a weekday (Mon...Sun) has been specified via the KNX in the telegram last received.
When using the 8-byte data type (DPT 19.001), the weekday (Mon...Sun) specified in the telegram can optionally be declared as invalid ("not valid"). If a time with such a specification was received, effects will then no longer be started or stopped automatically by the timer. The timer first processes the set start and stop times again as soon as valid weekdays are specified in a new telegram. With the 8-byte data format, the specified time can also be declared as invalid if necessary. In this case, too, effects will no longer be started or stopped automatically by the timer until a new valid time is specified.
- i** To ensure high accuracy, we recommend setting the time of the timer via a KNX telegram at least once a day.
- i** As long as no valid time has been received after a device reset (mains voltage return, device restart), the timer processes no start and stop times.

Once the timer function has been enabled globally under "Effects", all or individual effects can be assigned to the timer independently of one another. Each effect will then have a start and stop time. These times can be assigned to any of the weekdays.

The timer function must be enabled globally.

- Set the parameter "Set start time?" to "yes" if the effect should be started automatically via the timer. In the parameter "Effect start time", define the time for the start and weekdays when the start time should be executed.
The timer starts the effect at the specified time on the defined weekdays. Furthermore, the effect can be started at any time via the communication objects (1-bit or 1-byte extension) or via the DALI test function.
 - Set the parameter "Set stop time?" to "yes" if the effect should be stopped automatically via the timer. In the parameter "Effect stop time", define the time for stopping and the weekdays when the stop time should be executed.
The timer stops the effect at the specified time on the defined weekdays. Furthermore, the effect can be stopped at any time via the communication objects (1-bit or 1-byte extension) or via the DALI test function.

Set start time?	yes
Effect start time	Mo Tu We Th Fr Sa Su 08:00:00 [hh:mm:ss]
Set stop time?	yes
Effect stop time	Mo Tu We Th Fr Sa Su 16:00:00 [hh:mm:ss]

Figure 60: Example of an effect configuration with start and stop time for the timer (here: automatic starting at 8:00 and stopping 16:00 on Mon...Fri)

- i** There is always just one start time and one stop time per effect, which is executed on the configured weekdays. Thus, it is not possible to start an effect on the same day or on different days at different times of the day. Likewise, it is not possible to stop an effect at different times on the same day or on different days.

- i** If the start and stop time of an effect was configured at the same time of day and the times are active on the same weekdays, the timer first executes a start and a stop immediately after that. Therefore, it may happen that an effect actually starts and the first effect step is executed before the automatic stopping of the effect by the timer occurs. As a result, effects are then not processed completely. For this reason, identical start and stop times that are effective on the same weekdays should be avoided.
- i** The timer always chronologically processes the configured start and stop times of all effects consecutively to the second (effect 1...16 start time / effect 1...16 stop time). When setting the time of day via the KNX, the timer re-evaluates the start and stop times for each effect and decides whether the times and thus the starting and stopping of an effect must be repeated. The timer only repeats a start or stop time if this is no longer than 60 seconds in the past starting from the newly received time. Attention must be paid to this property especially when setting the timer to a summer/wintertime changeover.
Examples:
Current time: 1:59:59, configured start time: 2:00:00 -> Even before the internal clock of the Gateway switches to 2:00:00, the new time 3:00:00 is already received. -> The timer does not execute the start time since it is too far in the past.
Current time: 1:59:59, configured start time: 3:00:00 -> The new time 3:00:10 is received via the KNX. -> The timer executes the start time since it is in the timeframe of the retroactive view.
- i** If a start or stop time has already been processed during a day, this time will not be executed a second time on the same day (e.g. by resetting the time). After a change of day, (i.e. after 00:00:00 / initiated by the time of day itself or by a change of day in the KNX-time telegram), the timer first evaluates all start and stop times anew if necessary and executes start and stop times later in the course of the day according to the configured times and depending on the set weekday.

Disabling functions allow deactivation of the timer if necessary and can thus inhibit an automatic start or stop command. The configured start and stop times of an effect are not processed during an active disabling function. It is only possible to start or stop an effect during an active disabling function by the communication objects or via the DALI test function.

Each effect has its own disabling function so that start and stop times of individual effects can be deactivated individually. Each disabling function has a separate 1-bit disabling object for which the telegram polarity can be defined.

The disabling functions can be used, for example, if the automatic starting and stopping of effects should be suppressed during absence or on holidays.

The timer function must be enabled globally.

- Set the parameter "Use disabling function for timer?" to "yes". In the parameter "Polarity disabling object for timer" configure the polarity of the disabling telegram.

The 1-bit disabling object is available. The disabling function can be activated and deactivated via the KNX according to the configured polarity if necessary.

- i** The disabling functions are always deactivated (object value = "OFF") after a device reset. If the parameter "Polarity disabling object for timer" is configured to "1 = enabled / 0 = disabled", an "OFF" telegram must first be sent to the disabling object after a device reset so that the disabling function is activated.

- Set the parameter "Use disabling function for timer?" to "no".

The timer disabling function is not available. Effects can only be started and stopped via the communication objects or via the DALI test function.

The behaviour of an effect can be defined at the beginning and end of the associated disabling function. In this way, a disabling function can stop selectively, or alternatively, just inhibit the execution of the start and stop times of the timer. When deactivating the disabling functions, effects can be selectively started or stopped. Here too, it is optionally possible to inhibit the automatic execution of the start and stop times.

- Set the parameter "Behaviour at the beginning of the disabling function" to the required response.

In the "no change" setting, the execution of the start and stop times is inhibited by the timer immediately at the beginning of the disabling function. This reaction also takes place in the "Stop effect" setting. Additionally, the effect is then also stopped.

- Set the parameter "Behaviour at the end of the disabling function" to the required response.

In the "no change" setting, the execution of the start and stop times is enabled again by the timer at the end of the disabling function. The timer does not repeat any start or stop times that were suppressed during an active disabling function. In the "Start effect" setting, the effect is additionally started. The stopping of the effect at the end of the disabling function can be specifically induced by the "Stop effect" setting.

- ❗ Starting an effect that has already started or stopping an effect that has already stopped shows no reaction. An effect must first be stopped, in order to restart it in a defined manner at Step 1.

4.2.4.6 Emergency lighting

The DALI Gateway can be integrated into DALI emergency lighting systems. It allows interference-free operation of operating devices, general lighting systems and emergency lighting operating devices of the same DALI system. The device is able to integrate standard DALI operating devices for lighting control according to IEC 62386-101 (DALI System) and IEC 62386-102 (Control Gear) into centrally-supplied emergency lighting systems as an emergency light.

The application principles of a DALI emergency lighting system (emergency light system, scope of emergency operation, types of emergency lights) are described in more detail in the chapter "Application principles - DALI emergency lighting systems".

- i** **The statutory and standard specifications vary from country to country. In any event, the user / technical planner should check whether the specific specifications should be maintained.**

The function "Emergency lighting" is enabled if the parameter "Integration of emergency lights ?" in the ETS plug-in of the DALI Gateway in the parameter node "General", is set to "yes" per limiting value. In this case, the parameter node "Emergency lights", which contains all the relevant parameters for configuring the emergency lighting function, becomes visible. The following chapters describe the configuration of individual functions of emergency light integration in the ETS plug-in.

4.2.4.6.1 General configurations

Emergency lights system

No emergency lights with special DALI operating devices are used in an emergency lighting system, supplied by group or central battery systems. Instead, standard devices are used according to the basic DALI standards. These devices, which are primarily intended to control general DALI lighting systems, usually only possess one mains voltage connection and do not possess a battery for self-supply, should the mains voltage fail.

- i** This DALI Gateway cannot control any single-battery-operated DALI emergency lights according to IEC 62386-202.

Emergency lights overall status

The DALI Gateway is able to evaluate the operating status of all the DALI operating devices integrated into the emergency operation in accordance with the transferred error status, and to make them available collectively to other KNX devices in the form of 1-bit feedback via the object "Feedback, emergency lights, complete". The status of all the electronic ballasts integrated into the centrally supplied emergency operation is evaluated. If the Gateway only detects a malfunction of only one operating device or of multiple operating devices, it will set the object value to "1". Otherwise (error-free system), the object value is set to "0". This allows the central display of the complete status of a DALI emergency lighting system, e.g. on a KNX visualisation, meaning that further analyses (e.g. evaluation of the error statuses) can be carried out. An error is also present when the Gateway can no longer set up communication to an operating device integrated in emergency operation.

The complete status feedback can be used as an active message object or as a passive status object. As an active message object, the feedback information is also directly transmitted to the bus whenever there is an update. As a passive status object, there is no telegram transmission after an update. In this case, the object value must be read out. The ETS automatically sets the object communication flags required for proper functioning.

If used as an active message object, the complete status feedback state is transmitted to the bus after bus or mains voltage return or after programming with the ETS, should an error be present. In these cases, the feedback telegram can be time-delayed with the delay being preset globally for all device feedback together. If a time delay is required, the parameter "Time delay for feedback after bus voltage return" must be set to "yes". Otherwise ("no" setting), transmission of the active message telegram takes place immediately after a device reset and if there is an error.

Optionally, the complete status feedback, in its function as an active signalling object, can also be transmitted cyclically, in addition to transmission on an update. The parameter "Cyclical transmission of feedback telegram ?" specifies whether cyclical transmission is enabled or not. If enabled, the parameter "Time for cyclical transmission" on the same parameter page will define the cycle time.

4.2.4.6.2 Configurations for centrally-supplied emergency lights

Scope of emergency operation

In centrally-supplied emergency lighting systems, a distinction is made as to which parts of the electrical building installation are supplied by the emergency power supply. The parameter "Scope of emergency operation" in the parameter node "Emergency lights -> Centrally-supplied" (available if the emergency light system allows for centrally-supplied electronic ballasts) defines the scope of the emergency lighting systems...

- "Emergency lights" setting:
In this application, either all or just individual DALI operating devices are connected to the emergency power supply. The KNX system and DALI Gateway are not supplied with emergency power, which means that if the mains voltage fails, these subsystems will no longer function. If there is a fault, there is no DALI voltage because the power supply of the Gateway is no longer working.
- "Emergency lights & KNX system" setting:
In this application, all or individual DALI operating devices as well as the power supply of the KNX system are connected to the emergency power supply. The DALI Gateway is not supplied with emergency power, which means that it will no longer function if the mains voltage fails. If there is a fault, there is no DALI voltage because the power supply of the Gateway is no longer working. Since the KNX system continues working without interruption if the mains power fails, mains failure messages that the Gateway can produce before switch-off (feedback of supply voltage failure) can be evaluated and processed.
- "Emergency lights & KNX system & DALI Gateway" setting:
In this application, all or individual DALI operating devices, the power supply of the KNX system and the mains voltage connection of the DALI Gateway are connected to the emergency power supply. If there is a fault, DALI voltage will remain since the power supply of the Gateway continues working. This application offers the greatest flexibility, since the DALI Gateway can continue to control the operating devices. In this application, the DALI operating devices do not switch automatically to the "System Failure Level". Instead, the Gateway controls selected operating devices at a special brightness value for emergency operation. This brightness can be configured in the ETS plug-in within the limits of minimum and maximum brightness if necessary. Alternatively, it is possible to define no special behaviour at the beginning of emergency operation. In this case, the operating devices assigned to emergency operation remain at the last set brightness value.

Integration of operating devices

The Gateway requires the information of which of the DALI operating devices are integrated into centrally-supplied emergency operation. Furthermore, it is necessary to define the brightness value, optionally also the colour temperature or the behaviour for emergency operation. Each group and device of the single addressing in the project design has special parameters for this purpose. These parameters are available in the parameter node "Addressing -> Groups... -> [x] Group -> "Emergency lights, centrally-supplied" or "Addressing -> Single devices... -> [x] Electronic ballast -> Emergency lights, centrally-supplied".

Regardless of whether the scope of emergency operation also includes the Gateway (see parameter "Scope of emergency operation"), the behaviour of all the electronic ballasts of a DALI group or all the single devices in emergency operation can be influenced differently...

- Emergency operation only comprises DALI lights:
Due to the switched-off DALI voltage, the operating devices supplied with emergency current set the "System Failure Level" saved in the device at the beginning of emergency operation as the brightness value. This brightness value was written by the DALI Gateway to the DALI operating devices after ETS commissioning. By default, the "System Failure Level" is defined by the "Behaviour in case of bus voltage failure" parameter of a group or single device. Optionally, this value - irrespective of the behaviour in case of bus voltage failure - can be set to a separate brightness value for emergency operation. For this purpose, set the parameter "Define separate brightness value for emergency operation ?" to "yes". The parameter "Brightness value in emergency operation" then available defines the value for the "System Failure Level" regardless of the behaviour in case of bus voltage failure.
When activating operating devices that support the device type "Colour Control" (DALI Device Type 8), the effective colour temperature in emergency operation does not change in this configuration. The Gateway initialises the DALI operating devices so that the colour temperature remains unchanged if the DALI voltage fails.
- Emergency operation comprises DALI lights and KNX system:
Even in this case, due to the switched-off DALI voltage, the operating devices supplied with emergency current set the "System Failure Level" saved in the device at the beginning of emergency operation. As in the application "Emergency operation only comprises DALI lights", this brightness value was written by the DALI Gateway to the DALI operating devices after ETS commissioning. Optionally, this value - irrespective of the behaviour in case of bus voltage failure - can be set to a separate brightness value for emergency operation. For this purpose, set the parameter "Define separate brightness value for emergency operation ?" to "yes". The parameter "Brightness value in emergency operation" then available defines the value for the "System Failure Level" regardless of the behaviour in case of bus voltage failure.
When activating operating devices that support the device type "Colour Control" (DALI Device Type 8), the effective colour temperature in emergency operation does not change even in this configuration. The Gateway initialises the DALI operating devices so that the colour temperature remains unchanged if the DALI voltage fails.
- Emergency operation comprises DALI lights, KNX system and DALI Gateway (recommended application):
In this application, the DALI operating devices do not switch automatically to the "System Failure Level". Instead, the Gateway controls selected operating devices to the brightness value specified by the parameter "Brightness at the start of emergency operation". This parameter is available if the parameter "Define behaviour at the start of emergency operation ?" is configured to "yes". Otherwise ("no" setting), the operating devices assigned to emergency operation remain at the last set brightness values.
The brightness value specified by the parameter "Brightness at the start of emergency operation" is also entered into the DALI operating devices as the System Failure Level. If the mains voltage supply of the DALI Gateway should fail, and consequently the DALI voltage, the operating devices affected will also set themselves to this brightness value. If the parameter is unavailable (parameter "Define behaviour at the start of emergency operation ?" set to "no"), the "System Failure Level" is defined by the "Behaviour in case of bus voltage failure" parameter of a group or single device.
When activating operating devices that support the device type "Colour Control" (DALI Device Type 8), a colour temperature can also be defined for the emergency operation besides a brightness value in this configuration. The parameter "Colour temperature at the beginning of emergency operation" specifies this colour temperature value and is available as long as the parameter "Define behaviour at the start of emergency operation ?" is configured to "yes". Otherwise ("no" setting), the operating devices assigned to emergency operation remain at the last set colour temperature value.

- i** DALI groups or single devices integrated in centrally supplied emergency lighting operation cannot be assigned to any scene and effect! Assignments to scenes and effects are lost if the integration of groups or devices takes place later in emergency operation. In these cases, the ETS plug-in warns of losing assignments.

Monitoring power supply failure

If the scope of emergency operation also allows for the integration of the DALI Gateway, the Gateway will activate emergency operation. It instigates all the appropriate actions on the KNX and the DALI page. Identification of a mains failure as the cause of emergency operation can take place in different ways. Either the Gateway automatically identifies whether mains voltage is present (internal failure messages) or not using the diagnosis of the DALI operating devices. This is possible through contacting and reading out all commissioned DALI devices. If a number of these devices specified by the programmer do not respond, the Gateway will assume that the mains voltage has failed.

In addition, or alternatively, a KNX telegram can inform the Gateway that emergency operation is to be activated (external failure message). This is useful, for example, when a KNX binary input is monitoring the mains voltage and transmits a message telegram if there is a mains failure.

The parameter "Monitoring for the failure of the general power supply ?" in the parameter node "Emergency lights -> Centrally-supplied -> Emergency lights & KNX system & DALI Gateway" defines whether the detection of a mains voltage failure will take place using an internal DALI failure message or, alternatively, using an external KNX failure message. Both options can be combined and linked logically (AND, OR), which means that a higher guarantee of detection or redundancy can be implemented during failure detection.

- Internal DALI failure message:
With the internal DALI failure message, all the planned and commissioned DALI operating devices are polled cyclically (same interval in seconds as for determining the error status). Should one of the devices no longer respond to the Gateway, the operating device concerned will be saved internally as "failed". As a result, the DALI Gateway will assume that the mains voltage supply of the DALI operating device has failed. In the ETS plug-in, the parameter "Maximum number of failed devices" (1...64) can be used to define how many devices must be identified as "failed" for the Gateway to activate emergency operation. If the number of failed devices reaches or exceeds the configured limit value, then failure of the general mains power supply is assumed. If the limit value was not reached, the Gateway will remain in normal operation.
- i** The standard setting of the parameter "Maximum number of failed devices" is "64", which means that all the DALI operating devices must fail before emergency operation is activated. This number is not usually reached in practical applications since emergency lighting systems always have some electronic ballasts integrated into the central emergency power supply. Consequently, these operating devices do not fail in the event of a mains voltage failure and can therefore not be identified by the Gateway as "failed", which means that the maximum limit value of 64 operating devices can never be reached. If the internal DALI failure message is being used, the parameter "Maximum number of failed devices" must always then be set to the required number of devices and thus adjusted to the number of DALI subscribers in the DALI system which are not supplied with emergency current.
- External KNX failure message:
In the case of the external KNX failure message, a different KNX bus device (e.g. binary input) can inform the DALI Gateway via the 1-bit object ("Failure, external supply") that the general mains voltage supply has failed. With this, the Gateway then activates emergency operation. The telegram polarity of the object is fixed: "1" = Mains voltage has failed, "0" = Mains voltage available.

- i** Updates to the object "Failure, external supply" from "1" to "1" or "0" to "0" do not produce any reaction.

If the internal and external failure messages are interlinked, the Gateway will then use the set logical link to test whether emergency operation is to be activated or not. In the setting "Failure message DALI OR KNX (internal OR external)", the Gateway must either have independently identified that the defined number of DALI devices has failed, or must have been informed externally about the mains failure. Only one positive failure message is decisive in activating emergency operation.

In the setting "Failure message DALI AND KNX (internal AND external)", both the internal and external evaluation must be positive in order for the emergency operation to be activated. If only one failure message is active, emergency operation will not be activated. In addition, active emergency operation will be terminated as soon as a failure message becomes inactive again.

- i** After a device reset (mains voltage failure and return on the Gateway, ETS programming operation), emergency operation is always deactivated.

Message: Failure, general supply

A 1-bit failure telegram can be transmitted to the KNX as feedback either through the internal failure message, or alternatively, through the external failure message, provided that the Gateway has activated emergency operation. This allows other bus devices evaluating this feedback (e.g. other KNX DALI Gateways) to react and also activate emergency operation. Automatic identification of a mains voltage failure is usually not necessary with these devices, which means that only one DALI Gateway in the KNX system needs to be integrated actively into mains failure detection.

If necessary, the object "Feedback, supply failure" is enabled by the parameter "Message, general supply failure ?" in the parameter node "Emergency lights -> Centrally-supplied -> Emergency lights & KNX system & DALI Gateway". This object causes telegram transmission as soon as the Gateway activates ("1 telegram / mains voltage failed) or deactivates ("0" telegram / mains voltage available again) emergency operation.

- i** After a device reset (mains voltage failure and return on the Gateway, ETS programming operation), emergency operation is always deactivated. No telegram transmission takes place via the object "Feedback, supply failure", not even if emergency operation was active before the reset.
- i** "Feedback, supply failure" is transmitted immediately as soon as the Gateway detects the failure or return of the mains voltage. It should be noted that the deactivation of emergency operation after the return of mains voltage can take place after a delay. Feedback is not generated if emergency operation was activated or deactivated using the object "Emergency operation, external message".

Reaction to external message

The DALI Gateway does not need to monitor its own DALI system or external failure messages itself in order to identify the failure of the general mains voltage supply and thus to activate emergency operation. Optionally, it can be switched to emergency operation by an external message. When using the external message, only one DALI Gateway (Master) in the KNX system needs to be integrated actively into mains failure detection. All other Gateways - if available - will then evaluate the external feedback of this Master. Alternatively, a Gateway can be controlled using the external message from any KNX device.

If necessary, the object "Emergency operation, external message" is enabled by the parameter "Allow reaction to external message ?" in the parameter node "Emergency lights -> Centrally-supplied -> Emergency lights & KNX system & DALI Gateway". Using this 1-bit object, a different KNX bus device (e.g. another DALI Gateway -> link to the object "Feedback, supply failure") can inform the DALI Gateway that emergency operation has been activated. Through this, the Gateway then activates emergency operation, without having to identify the failure of

the general mains voltage supply itself. The telegram polarity is fixed: "1" = Mains voltage has failed / Activate emergency operation, "0" = Mains voltage available / Deactivate emergency operation.

- i** In special cases, it is possible to combine the monitoring for failures in the mains voltage supply (through an internal and/or external failure message) with the reaction to an external message. This is useful, for example, when the Gateway is to monitor the existence of mains voltage independently and, in addition, it must be possible to execute the forced activation and deactivation of emergency operation - for example for servicing purposes. Emergency operation can be controlled independently using the object "Emergency operation, external message" to monitor for failures in the general mains voltage supply.

Behaviour at the end of emergency operation

If the Gateway deactivates emergency operation (due to internal or external failure monitoring of the mains voltage or an external message telegram), all the DALI groups or single devices integrated in centrally supplied emergency operation are switched to defined brightness colour temperature states (colour temperature only when using the tunable white function). The behaviour at the end of emergency operation is specified globally by the parameter of the same name in the parameter node "Emergency lights -> Centrally supplied -> Emergency lights & KNX system & DALI Gateway" separated for brightness and colour temperature. This means that the switching off or the activation of a defined brightness value can be configured. Alternatively, the brightness value active before emergency operation or the brightness value tracked internally during emergency operation can be set. As a final alternative, it is possible to retain the current state of all operating devices.

The colour temperature can be influenced at the end of emergency operation so that either a colour temperature value is specified or the internally tracked colour temperature is set during emergency operation. As a further option, the effective colour temperature during active emergency operation can remain unchanged at the end of emergency operation.

- i** In the settings "Brightness value" or "Colour temperature value", values can be configured in the full value range without restriction. The minimum and maximum values of the individual DALI groups or single devices are not taken into account here when setting the parameter. If brightness values or colour temperature values that undershoot the individual minimum values or exceed the maximum values are defined for the behaviour at the end of emergency operation, then the groups or single devices concerned are limited to the corresponding limit values.

Deactivation of emergency operation and thus the execution of the behaviour at the end of emergency operation can take place after a delay. A time delay is advisable in order to give DALI operating devices without an emergency current supply sufficient time after the return of mains voltage to switch on at the operating brightness and colour temperature. The delay time means that DALI emergency lights are only switched off or switched to normal operation when the standard lighting is ready for operation.

The parameter "Delay time at the end of emergency operation" defines the period of time from the identification of the return of mains voltage until the actual deactivation of emergency operation. In the "00:00" setting, emergency operation is deactivated without a delay.

- i** If the mains voltage fails again during a delay or an external message telegram forces the Gateway into emergency operation, emergency operation will remain activated without interruption.

Feedback emergency operation

The DALI Gateway is able to make the state of emergency operation available on the KNX in the form of 1-bit feedback via the object "Feedback, emergency operation status". This allows other KNX bus devices to be informed about emergency operation in order to control displays for users (e.g. in a visualisation) or to carry out further actions (e.g. remote forwarding via the telephone or IP data network through suitable KNX components). If emergency operation is

activated, the Gateway sets the object value to "1". Otherwise (emergency operation deactivated), the object value is set to "0".

If the feedback function is to be used, it must be enabled in the parameter node "Emergency lights -> Centrally-supplied -> Emergency lights & KNX system & DALI Gateway -> Feedback, emergency operation" using the parameter "Feedback 'Emergency operation status' ?".

The emergency operation feedback can be used as an active message object or as a passive status object. As an active message object, the feedback information is also directly transmitted to the bus whenever there is an update. As a passive status object, there is no telegram transmission after an update. In this case, the object value must be read out. The ETS automatically sets the object communication flags required for proper functioning.

If used as an active message object, the feedback state is transmitted to the bus after bus or mains voltage return or after programming with the ETS, provided that emergency operation is activated. In these cases, the feedback telegram can be time-delayed with the delay being preset globally for all device feedback together (see page 68). If a time delay is required, the parameter "Time delay for feedback after bus voltage return ?" must be set to "yes". Otherwise ("no" setting), transmission of the active message telegram takes place immediately after a device reset and if there is active emergency operation.

Optionally, the emergency operation feedback in its function as an active signalling object can also be transmitted cyclically, in addition to transmission on an update. The parameter "Cyclical transmission of feedback telegram ?" specifies whether cyclical transmission is enabled or not. If enabled, the parameter "Time for cyclical transmission" on the same parameter page will define the cycle time.

- i After a device reset (mains voltage failure and return on the Gateway, ETS programming operation), emergency operation is always deactivated. No telegram transmission takes place via the active object "Feedback, emergency operation status", not even if emergency operation was active before the reset.

4.2.4.7 DALI commissioning

4.2.4.7.1 Starting DALI commissioning

It is easy to configure the devices of the DALI Gateway, including the configuration of the DALI groups, the single devices, the scenes and effects using the plug-in embedded in the ETS. In addition, DALI commissioning via the KNX bus cable can also be performed using the plug-in. No additional tool and no special programming connection is required.

DALI commissioning must be performed after device configuration has been completed (all groups and single devices created / scenes, effects and emergency lights configured / all group addresses assigned). In addition, it is necessary that the DALI Gateway has been programmed with the ETS at least once before DALI commissioning so that the device has a physical address and the application program is loaded .

- i** DALI commissioning is not necessary, and thus not available in the ETS plug-in if the addressing allows for a master control.

If the necessary requirements have been fulfilled, "DALI commissioning" can be executed on the parameter page of the same name in the plug-in. After selecting the commissioning page and successful communication with the DALI Gateway, the commissioning environment becomes visible in the right-hand pane of the plug-in (figure 61).

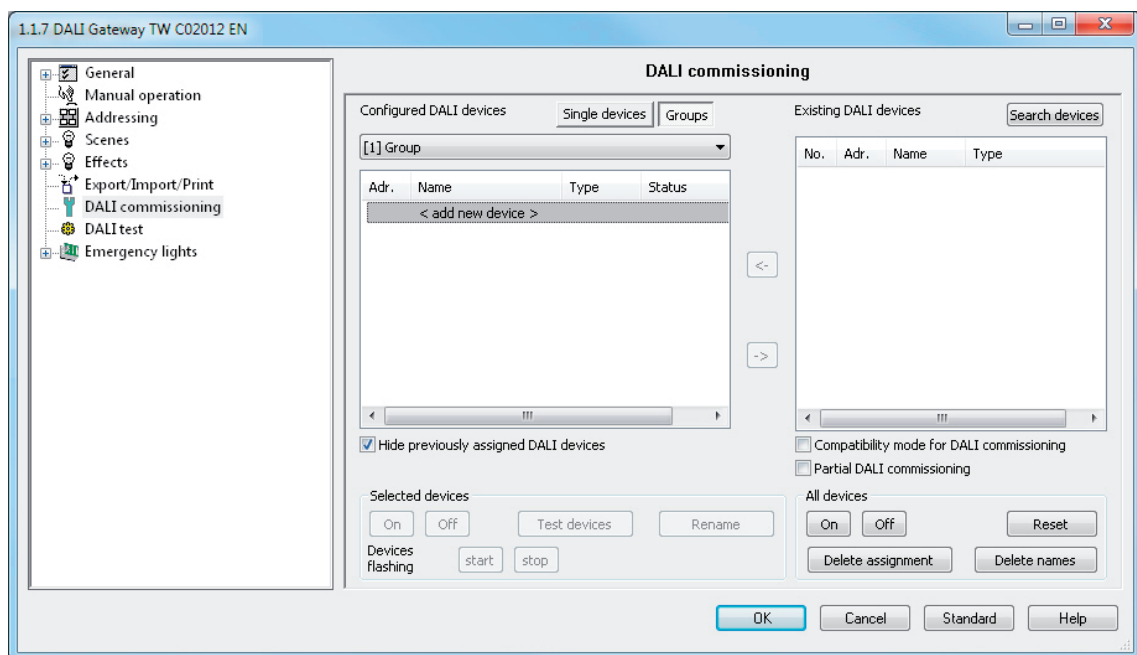

Figure 61: DALI commissioning environment in the ETS plug-in

When the commissioning environment is recalled, the plug-in first tries to communicate with the DALI Gateway via the KNX bus connection of the ETS (figure 62) and checks whether DALI commissioning is possible. For this reason, the DALI Gateway must be connected to the KNX bus cable and the bus and mains voltage supply must be switched on when DALI commissioning is recalled. In addition, the ETS must have a functioning communications interface to the bus (e.g. USB or KNXnet/IP).

- i** In this situation, the Gateway does not check the function of the DALI cable.

If it is not possible to setup a connection to the DALI Gateway in this situation, the plug-in will terminate commissioning. The commissioning environment will become visible even though the commissioning functions are not available. The following section lists the causes for a faulty connection and the appropriate remedies...

- Cause: No functioning ETS communication interface to the KNX.
Remedy: Check, and if necessary, setup the connection in the ETS.
- Cause: Physical address and application program not previously programmed by the ETS.
Remedy: Close the plug-in and first program the physical address and application program.
- Cause: KNX bus voltage on the DALI Gateway or the local data interface not connected or switched on.
Remedy: Connect and switch on the bus voltage.
- Cause: Mains voltage supply on the DALI Gateway not switched on.
Remedy: Switch on the mains supply on the Gateway.

i DALI commissioning can only be carried out if the application program programmed in the ETS is also available in the Gateway, i.e. was loaded into the device in a previous ETS programming operation. For this purpose, the application number and the application version in the device are tested. If this data does not match the specifications of the ETS project, the ETS plug-in will not offer any further commissioning functions. Here, the application program configured in the ETS must first be loaded into the Gateway. This information must particularly be observed in the case of different language variants (each variant has a different application version).

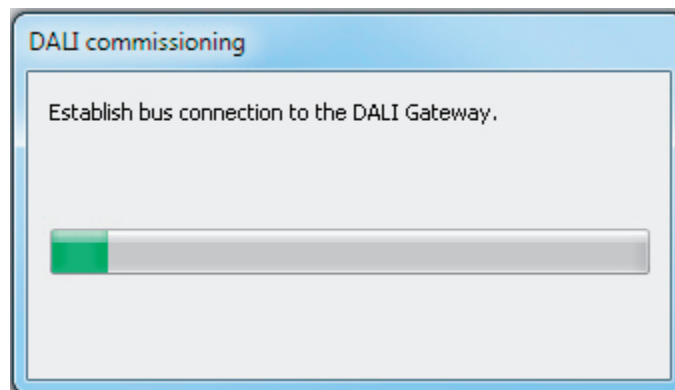

Figure 62: Setting up a bus connection to the DALI Gateway for DALI commissioning

Next, DALI commissioning can be carried out, for example by assigning the DALI operating devices to the configured groups or single devices.

4.2.4.7.2 Performing DALI commissioning

During DALI commissioning, the max. 64 DALI operating devices of a DALI system are assigned to the programmed groups or single devices of the Gateway. Only this assignment creates the option of controlling the DALI operating devices individually or jointly via the KNX. The "addressing type" defined in the ETS plug-in specifies whether group and/or single device control is possible.

Any number of DALI operating devices can be assigned to groups 1...16. On the DALI side, addressing takes place using group addresses, which the Gateway configures invisibly for the user and manages on its own. During DALI commissioning, the operating devices concerned are automatically programmed accordingly. In contrast, only up to two DALI operating devices can be assigned to groups 17...32. Since there are no DALI group addresses for these groups, DALI addressing takes place using the device short addresses, which means that the operating devices are addressed, and thus contacted, individually.

Alternatively, DALI operating devices can be addressed as single devices. The addressing of these devices takes place individually using the device short addresses.

- i DALI operating devices can either be integrated only in single device addressing, or alternatively, in group addressing. It is not possible to control an operating device with both addressing types. Operating devices integrated in group control can no longer be addressed as a single device. The reverse case applies in the same manner.

The commissioning environment of the plug-in is divided up into two panes. The right-hand pane lists the operating devices found in the DALI system. The left-hand pane displays the created groups. The assignment of the DALI devices to the programmed groups or single devices also takes place there.(figure 63).

The pane of the programmed DALI devices (A) displays all the groups and single devices configured in the ETS plug-in. In the later course of DALI commissioning, this area plays host to the assignment to found electronic ballasts of the DALI system. Groups can contain multiple electronic ballasts, whereby single devices can only ever contain one electronic ballast. Select whether the panel displays groups or single devices, thus allowing assignments to these elements, by pressing the **Single devices** or **Groups** buttons in the top area of the pane. Single devices added to groups during DALI commissioning or as part of offline commissioning are also available in the "Single devices" view. This creates the option of detecting all the programmed single devices centrally in just one commissioning window.

Different columns of the window of the programmed devices show the programmed short addresses of the devices (1...64), the device names, optionally the DALI device types (if the use of device types is configured or required) and the assignment status of found electronic ballasts ("not assigned", "assigned"). The devices can be assigned individually, either in the project design of the single devices (under "Addressing -> Groups... -> [x] Group -> Single devices -> [x] Electronic ballast" or "Addressing -> Single devices... -> [x] Electronic ballast") or alternatively, using the **Rename** button in the control panel of the commissioning dialog (E). This allows clear labelling of the operating devices (e.g. "Lamp, entrance area" or "Light strip, window, south").

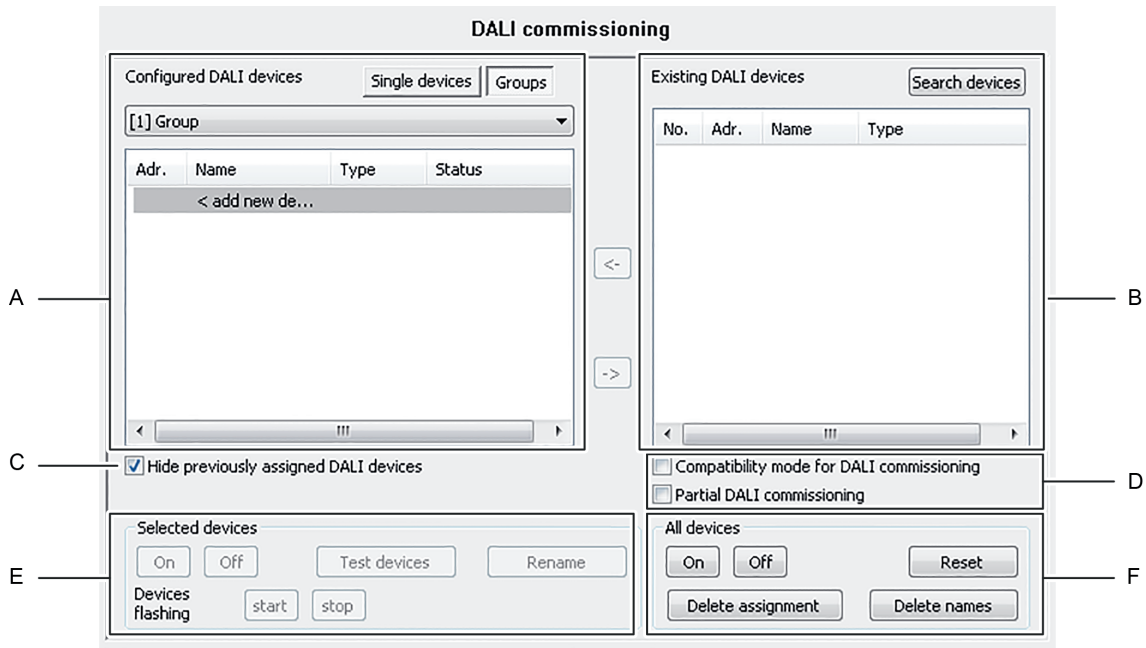

Figure 63: Panes of the commissioning environment

- (A) Area of the programmed DALI devices (groups and single devices)
- (B) Area of the found DALI devices (DALI system)
- (C) Checkbox for multiple assignment of electronic ballasts to DALI groups
- (D) Checkboxes for compatibility mode (see page 175) and partial DALI commissioning
- (E) Control panel for identification of selected devices
- (F) Control panel for central switching of all devices and general reset functions

In the pane for the found DALI devices (B), the plug-in shows all the electronic ballasts it could identify during a search process. All the electronic ballasts displayed in this area physically exist in the DALI system. As a result, a maximum of 64 operating devices are displayed here.

The window shows in different columns a consecutive number for sorting the contents of the window, the short addresses of the devices (1...64) and the DALI device types read out of the devices. The short address can only be displayed when a found device has been assigned to a programmed device (e.g. a single device or a group). The status of the electronic ballast assignment is only displayed in the pane of the found DALI devices when the checkbox "Hide previously selected DALI devices" was deselected in the commissioning dialog of the ETS plug-in (C). Otherwise (normal case), previously assigned electronic ballasts are not displayed in the right-hand pane. "-" is displayed as the short address for all unassigned electronic ballasts.

A name is also displayed in the pane of the found DALI devices. If operating devices have not yet been assigned to any groups or single devices, the name is set to "Electronic ballast" as default. Only when assignment has been made does the window display the programmed name of the devices, provided that already assigned DALI devices are not hidden.

If the assignment of a found device to a programmed group or single device is removed, the name specified by the last assignment can optionally remain intact. When removing assignments, the plug-in asks whether the device name should be deleted or should remain unchanged as an alternative (figure 64).

Confirm with "Yes": The device name is reset in the right-hand window to the standard identifier "electronic ballast".

Confirm with "No": The names of the devices that are now no longer assigned remain unchanged in the right-hand window.

"Cancel": The assignments are not removed.

- i** By setting the checkbox "Memorise setting permanently?" the prompt of the plug-in for deleting device names can be suppressed when removing further assignments. This setting is retained until the plug-in is closed and reopened.

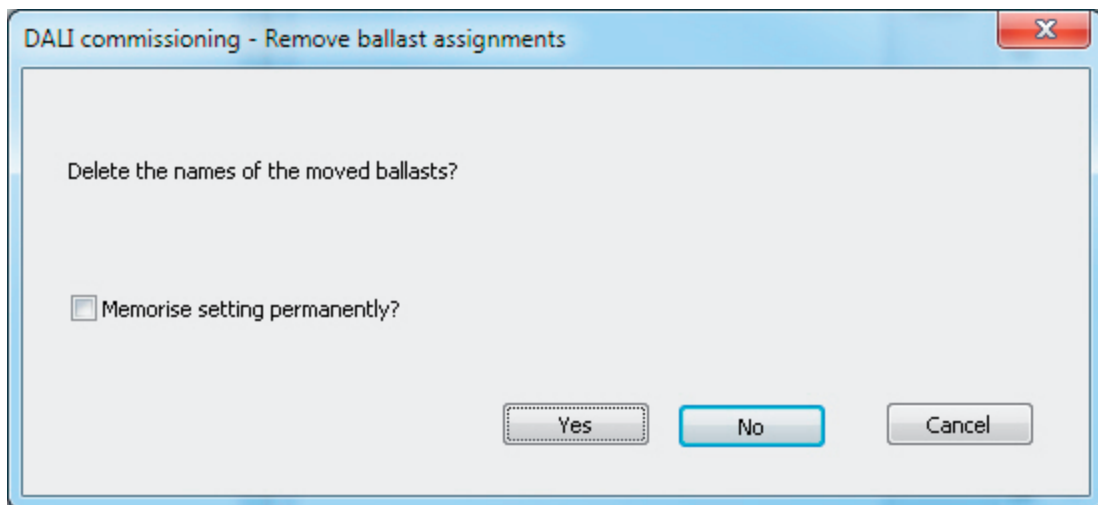

Figure 64: Prompt for deleting device names when removing assignments

Enabling the checkbox "Compatibility mode for DALI commissioning" (D) allows optional activation of the compatibility mode of the DALI commissioning. This means that the commissioning process becomes distinctly more tolerant towards specific DALI commissioning parameters, which means that operating devices not fully compliant with the DALI specification can be commissioned, possibly subject to functional restrictions.

The checkbox "partial DALI commissioning" influences the DALI device search. If this checkbox is enabled, operating devices that have already been found during a new DALI device search will be retained even if these do not respond to the Gateway (e.g. if the mains voltage supply of these operating devices is switched off or the DALI cable was disconnected). This allows DALI systems to be partially commissioned.

If the checkbox is disabled, operating devices that have already been found during a new device search will be removed from the configuration if these devices no longer respond to the Gateway.

Using the buttons in the control panel (E), it is possible to identify devices selected in the panes (A) and (B) in the DALI system. These operating devices can be made to switch-on, switch-off and flash (cyclical ON and OFF). It is also possible to rename devices.

By using buttons in the control panel (F) it is possible to switch all the operating devices in the DALI system (broadcast) on and off centrally. In addition, it is possible to reset all the devices of the DALI installation to the delivery states defined by the manufacturers by using the **Reset** button. In this operation, all the assignments to groups and single devices in the electronic ballasts are removed. Furthermore, the long and short addresses in the Gateway are deleted and the long addresses in the operating devices are reset. After the reset command has been executed, the pane of the found devices (B) no longer displays any electronic ballasts. A new search operation must then be restarted to be able to perform new DALI commissioning.

A reset should always be carried out with caution and then when previously commissioned electronic ballasts are integrated into DALI systems at a later date or if there are problems in DALI commissioning due to faulty commissioning steps (e.g. undesirable duplicate addresses, communication problems). The DALI reset creates a clean DALI environment as the basis for fault-free commissioning.

Press the **Delete assignment** button if only the assignments of found electronic ballasts to the programmed groups or single devices are to be removed. Here, only the group assignments in the operating devices and the single device assignments in the configuration of the ETS plug-in are deleted. Long and short addresses as well as other relevant parameters remain intact in the electronic ballasts.

By pressing the **Delete name** button the names of all devices found can be deleted in the right-

hand window. If all or some of the devices found are connected to programmed devices (left-hand window), then the name of the programmed devices concerned will be reset.

- i** It is not possible to reset individual or specific electronic ballasts.
- i** After a reset of the DALI system or after deletion of assignments, it is always necessary to reload the application program into the DALI Gateway after commissioning using the ETS.

Searching for DALI operating devices

During initial commissioning, the connected DALI operating devices must be searched for and identified. If the DALI Gateway has already been commissioned at least once, then the search for operating devices is only required if new devices were added to the DALI system or if the ETS product database was changed and hence the device is completely reconfigured. At the end of DALI commissioning, the commissioning parameters (identified operating devices with long and short address, names of the operating devices, group/device assignment and device type) are written to the ETS database and are thus saved. The saved data is displayed when the commissioning environment is started.

During initial commissioning, no DALI operating devices are displayed in the right-hand window area (B). To continue commissioning, the operating devices connected to the DALI cable must first be searched for. The devices affected must be connected to the DALI cable without interruption and operational in order for the DALI Gateway to be able to find and identify all necessary DALI operating devices during the device search! In addition, the mains voltage supply of the DALI Gateway must be switched on.

- Click the "Search for devices" button in the commissioning environment.

The DALI Gateway searches for available DALI operating devices. In so doing, the Gateway scans the DALI cable in stages and identifies the connected devices successively. Depending on the number of connected electronic ballasts, the search operation may take some time. During the search operation, the plug-in displays the progress of the search.(figure 65).

- i** During the search operation, the Gateway tells the DALI operating devices to create a random long address internally. This only takes place for devices which were identified as "newly found" at the beginning of the search operation. In addition, the Gateway already assigns short addresses in the background during the search process, which are then adapted using group and device assignments in the course of commissioning and can thus be overwritten.

The plug-in uses the long addresses to distinguish between the found operating devices being detected for the first time and those devices which were previously detected during commissioning. For this, the plug-in compares the read-in long addresses with the entries saved in the ETS database. Previously unknown long addresses indicate newly found devices.

Taking this distinction into account, the plug-in displays the newly found electronic ballasts in the search progress. In the case of first DALI commissioning, all the found operating devices are indicated as "newly found". In later commissioning operations, only those electronic ballasts are indicated as newly found, which were added to the DALI system.

- i** According to the DALI specification, all the DALI subscribers must save the long address permanently (e.g. even during mains voltage failures). Not all the DALI devices on the market support this requirement. If such operating devices are installed, compatibility mode should be activated. (see page 175). During a search operation, the Gateway then identifies solely by means of the DALI short address (1...64) contained in the devices. This means that electronic ballasts can be commissioned without accessing long addresses.

After completion of the search operation, all the identified operating devices (both old and new) are listed in the right-hand pane of the commissioning environment.(figure 66).

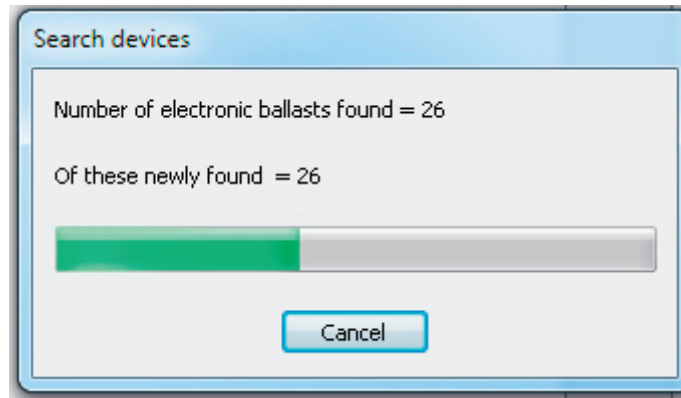

Figure 65: Example of search progress during a DALI operating device search

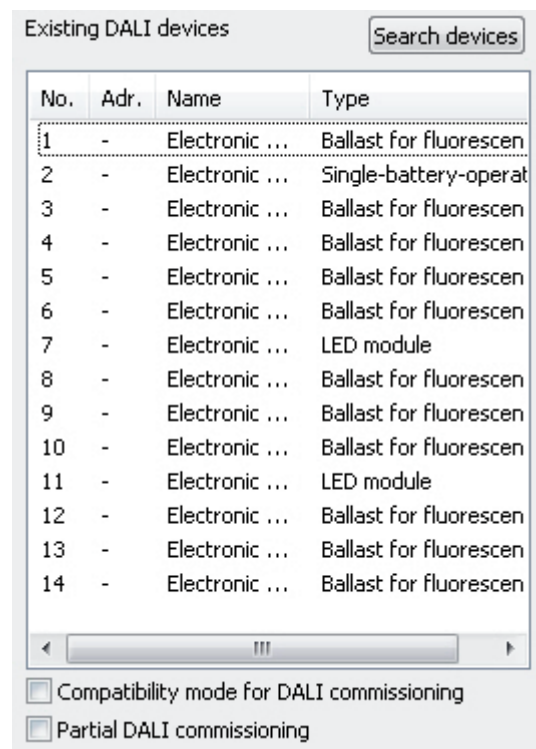

Figure 66: Example of a device list after a search operation

- i** An error on the DALI cable is not detected by the DALI Gateway during a device search. In the case of a short-circuit, for example, the Gateway attempts cyclically to set up DALI communication. As this is not possible, the plug-in remains permanently in the device search. DALI operating devices are not detected if there is a cable break, for example.
- i** During the device search, all the connected DALI operating devices switch to minimum brightness. This makes it possible to determine whether the devices are actually functioning and react to the device search.

Partial DALI commissioning:

The checkbox "partial DALI commissioning" influences the DALI device search. A distinction is made between the two following cases depending on whether the checkbox is enabled or disabled:

1. Checkbox enabled: Operating devices that have already been found during a new DALI device search will be retained even if these do not respond to the Gateway (e.g. if the mains voltage supply of these operating devices is switched off or the DALI cable was disconnected). This allows DALI systems to be partially commissioned (e.g. commissioning of multiple construction phases). With this setting, make sure that no more than 64 operating devices are connected in the overall extension of the DALI system!

2. Checkbox disabled: In this case, operating devices that have previously been found during a new device search will be removed from the configuration if these devices no longer respond to the Gateway. With this setting, ensure that the entire DALI system is switched on and ready for operation. Thus, it is not permissible to switch off previously commissioned electronic ballasts or to disconnect them from the DALI cable. During the entire commissioning process, fault-free communication must be guaranteed between the DALI Gateway and all DALI operating devices.

- i** Operating devices that have been found cannot be removed from the configuration when using the partial commissioning (checkbox enabled). It is only possible to remove operating devices that have already been found by permanently or temporarily switching to the standard commissioning (checkbox disabled) and by executing a new device search for which the previously found devices no longer respond. It should then be ensured that all other operating devices of the DALI system are connected to the DALI cable and are operational! Otherwise, devices will also be removed from the configuration, which should be retained.
- i** When using the partial commissioning (checkbox enabled) in conjunction with the compatibility mode, make sure that operating devices that should be partially searched for by a device search and newly added have not already been programmed with an invalid short address. This is the case, for example, if operating devices were already previously commissioned in another DALI system. Ideally, brand new operating devices partially in conjunction with the compatibility mode should only be commissioned. If this is not possible, it makes sense to carry out a DALI reset (resetting operating devices concerned to the delivery state). When doing so, make sure that the reset is only carried out if just the operating devices that should be newly added are connected to the DALI system. Otherwise, the operating devices that were already validly commissioned will be reset.

Assigning groups

After operating devices have been searched for and identified, the devices can be assigned to the programmed groups or single devices. The following sections document the individual actions to be taken to create a group assignment in the DALI commissioning environment.

- i** The assignment of DALI operating devices to groups is only then possible when the addressing type allows for group control.

Assignment always takes place by moving the devices listed in the right-hand section into the left-hand section. Assignment is carried out by pressing the <- button between the two sections, or alternatively, by "drag and drop" with the mouse. An assignment can be removed again by selecting an assigned operating device and, using the -> button or the mouse, shifting it back to the list box of available DALI devices. It is possible to assign multiple operating devices simultaneously, or to remove them from an assignment.

Each assigned electronic ballast requires a device in the Gateway project design, so that the device name, the short address and, optionally, the DALI device type can be configured. As a result, there is also a programmable single device for each group assignment of an electronic ballast. There are two options for assigning found electronic ballasts to a group...

1. Group assignment by creating a new single device in the group
Pressing the <- button automatically creates a new single device in the group. Here, no existing, and as yet unassigned single device of the group may be highlighted. Alternatively, assignment using "Drag and Drop" with the mouse is possible by dragging a found electronic ballast in the right-hand pane and dropping it into the left window in the area "<Add new device>" (first list entry). The plug-in automatically assigns the first free short address to the new device. The

device type is set according to the specification of the found electronic ballast.

2. Group assignment to an existing single device from the offline commissioning
In this case, first highlight a single device in the left-hand panel that was created during offline commissioning and has not yet been assigned (status "Not assigned"). After this, a found electronic ballast can be assigned to this single device using <- . Alternatively, assignment with the "drag and drop" function using the mouse is possible.

Single devices of a group can be deleted using the **Del** button on the PC keyboard and thus removed from the Gateway project design. The assignments to found electronic ballasts are also lost as a result. The same applies if a single device is deleted in the configuration independently of the DALI commissioning dialog. In both cases, the plug-in warns of losing assignments.

- i** DALI operating devices can either be integrated only in single device addressing, or alternatively, in group addressing. It is not possible to control an operating device with both addressing types. Operating devices integrated in group control can no longer be addressed as a single device. The reverse case applies in the same manner.

For special cases, it is possible to assign operating devices for group control to more than just one DALI group. In the standard case, assignment of a DALI operating device is only possible in one device. This makes device assignment clear, and the unique assignment means that there are no group overlaps and, as a result, no influencing of configuration and feedback values. If necessary, multiple group assignment can be enabled as an alternative. To do this, the checkbox "Hide previously assigned DALI devices" (C) must be deselected in the Commissioning dialog of the plug-in.(figure 63). This means that it is then possible to assign DALI operating devices to more than just one group during online commissioning.

- i** DALI operating devices can always be assigned to any group. However, we do not recommend assigning the operating devices to multiple groups on the DALI side. It is better to split the devices up into separate, non-overlapping groups and to create a KNX-side link using the group addressing in the ETS.
- i** Multiple assignment of operating devices as part of offline commissioning (creation of new single devices in the tree structure of a group) is not possible. When editing the short address in the parameter node of a group-related electronic ballast, no addresses can be entered that have already been entered for electronic ballasts of other groups.

Procedure for group assignment with set checkbox "Hide previously assigned DALI devices" (standard case):

- In the left-hand section of the DALI commissioning environment, select the required group to which the operating devices are to be added.(figure 67).

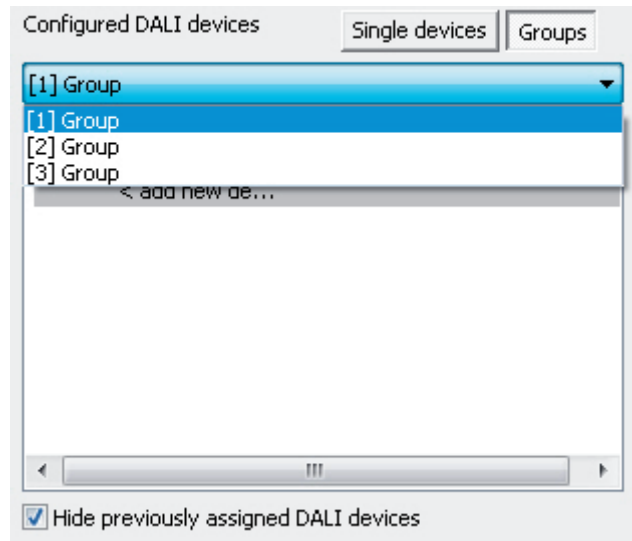

Figure 67: Selecting a group

- If new single devices are to be created (e.g. in empty groups), assign one or more found DALI operating devices using <- or "Drag and Drop" with the mouse. If an assignment is to take place to available free single devices, first highlight these in the left pane and then assign them using <- or, alternatively, using "Drag and Drop" with the mouse.

In the right-hand section, the assigned operating devices disappear from the list box and appear in the left-hand section for the selected group (figure 68). The right-hand pane contains only the remaining operating devices, which are not yet assigned to a group.

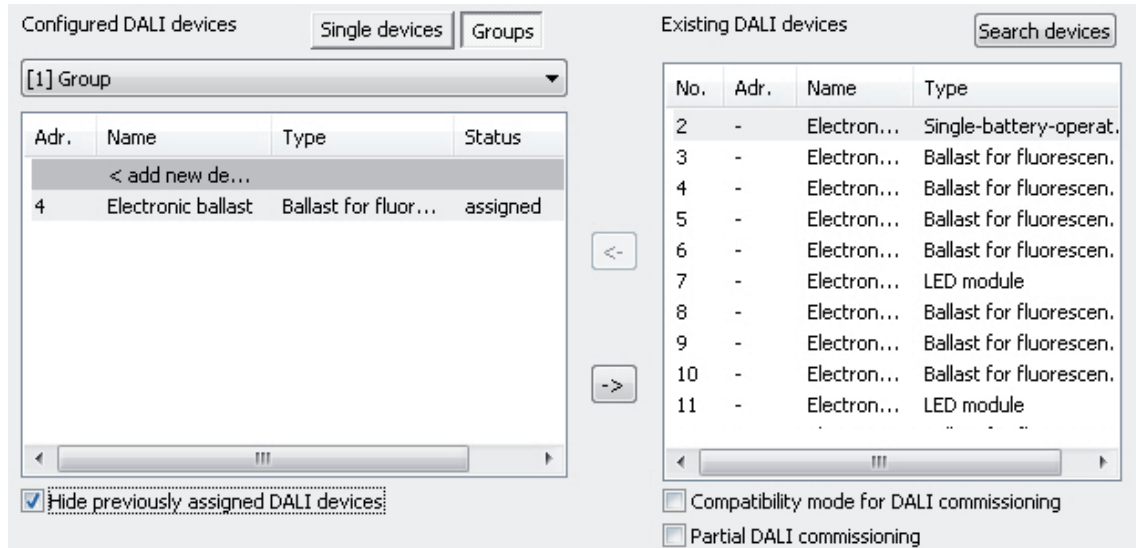

Figure 68: Operating device assigned to a group

- Once again, assign one or more of the remaining DALI operation devices to a group. In the right-hand section, the assigned operating devices disappear from the list box and appear in the left-hand section for the selected group.
- Carry out assignments for other groups as described if necessary.

Procedure for group assignment with deactivated checkbox "Hide previously assigned DALI devices" (special case):

- In the left-hand section of the DALI commissioning environment, select the required group to which the operating devices are to be added.
- Assign one or more available DALI operation devices to the group, as described above.
The assigned operating devices remain visible in the right-hand section and also appear in the left-hand section for the selected group.(figure 69). In the right-hand area, these electronic ballasts receive the short address of the assignment.

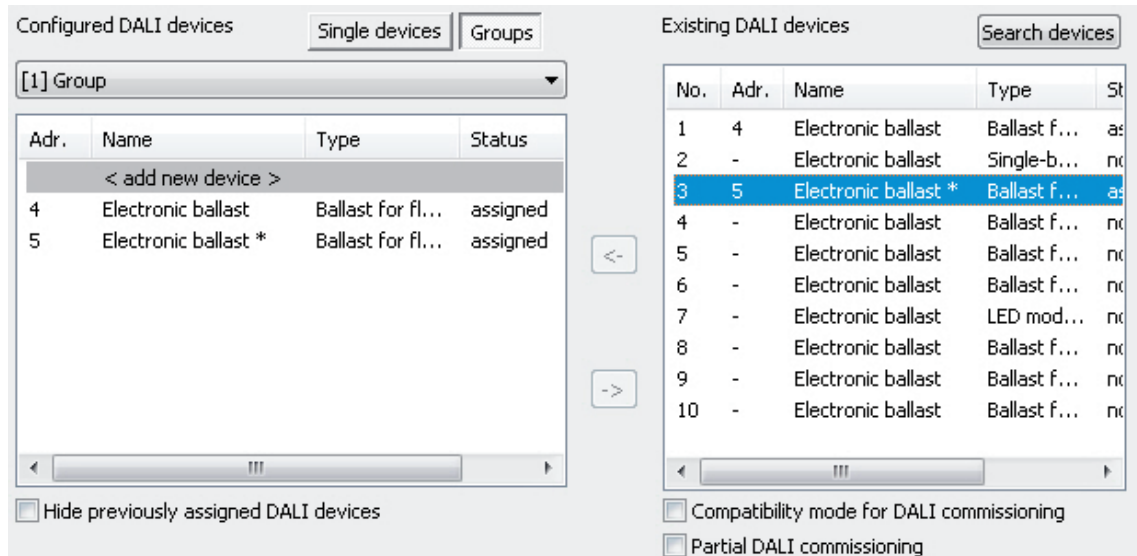

Figure 69: Operating device assigned to a group
Here: Electronic ballast with the address 3 is assigned to multiple groups.

- If necessary, select a further group in the left-hand section.
 - Once again, assign one or more available DALI operation devices to a group.
If a previously-assigned operation device is to be assigned to an additional group, the plug-in signals that the device has already been assigned to a different group and that feedback of switching states and brightness values may no longer be clear. After confirmation of the message, the plug-in sets up the multi-group assignment. Operating devices assigned to multiple groups are indicated by "*".
- Multiple assignment of an electronic ballast to different groups can only occur if a new device is created by the assignment. No new multiple assignment can be set up through the assignment to an existing device.
- i It is possible to remove the connection of an electronic device, which is assigned multiple times, in a group. In doing so, the assignments to all the groups of the multiple assignment are lost! However, the single devices remain in the appropriate groups of the project design (indicated by "*"). Only the assignment to the found electronic ballasts of the DALI system is removed. Such single devices in the project design can then be linked again to another electronic ballast. This electronic ballast then receives the multiple assignment again.
 - i Even devices that have the indication for a multiple assignment can be deleted from the left-hand section of the commissioning window using **Delete** on the keyboard. In doing so, only the single device is lost in the project design of the appropriate group, but not the other assignments in other groups, however. This means that it is easy to correct a multiple assignment, if this was created by mistake, for example.
 - Carry out assignments for other groups as described if necessary.
 - i Multiple operating devices can be assigned to Groups 1...16. Only up to two DALI operating devices can be assigned to Groups 17...32.

- i** DALI operating devices assigned to multiple groups always set themselves to the most recent status set using one of the assigned groups. In this case, feedback of the switching status or the brightness value of a group may not always be clear.
 Example 1: Group 2 is set to 10 % brightness. After this, Group 3 is dimmed to 20 % brightness. The lights of Group 3 assume the most recently recalled brightness value: 20 %. The feedback of Group 2 remains at 10 %, although some of the operating devices belonging to the group were set to 20 % brightness.
 Example 2: Group 2 is switched on and sets itself to the brightness value 100 %. The status of Group 3 internally in the DALI Gateway remains at 0 % brightness (OFF). Now Group 3 is made brighter. The lights of Group 3 adopt the dimming behaviour (becoming brighter from minimum brightness), although these lights have already been switched on by Group 2.
- i** Each group can be configured independently in the plug-in. During an ETS programming operation, the individual DALI operating devices are programmed with the configuration data of the assigned groups. In so doing, all the operating devices assigned to a DALI group are commissioned identically.
 If DALI operating devices are assigned to multiple groups, these devices will then receive the project design of the group with the highest group number.
- i** Pressing the **Delete assignment** button at the bottom edge of the commissioning environment allows deletion of all the assignments between the DALI operating devices and the various groups. Not only are the assignments reset in the plug-in, but there is also an adjustment of the commissioning parameters of the DALI Gateway. For this purpose, the plug-in sets up communication to the DALI Gateway via the bus connection of the ETS and deletes all the assignments in the device memory there. The operation may take some time. The progress is displayed during the Delete operation. If the bus communication is faulty, the plug-in terminates the operation without deleting the assignments in the project design or in the device. Previously identified DALI operating devices remain intact, but without group assignments.
- i** Pressing the **Standard** button deletes assignments of DALI operating devices to groups. The parameters of the DALI commissioning ("Hide previously assigned DALI devices", "Compatibility mode for DALI commissioning" and "Partial DALI commissioning") are not reset here to the Standard configuration". These parameters always remain at the states last set.

Optionally, the assignment of DALI operating devices to programmed devices can be supplemented by testing the DALI device types. If testing is enabled, the plug-in within the course of an assignment during online commissioning compares the device types determined by the operating devices with the specifications by the device type parameters of the offline configuration. Assignment can only take place if there is agreement. This will prevent functional incompatibilities after commissioning. The testing of the device types is influenced by the "Use 'DALI device type' setting ?" parameter in the parameter node "General".

Procedure when moving assigned devices between groups

Devices assigned to groups during the DALI commissioning can be moved directly to other groups via a simple command if necessary. This is possible by selecting a device assigned to a group in the view of all single devices and then clicking the right mouse button. This opens a context menu, in which you can move the selected device to another available group (figure 70).

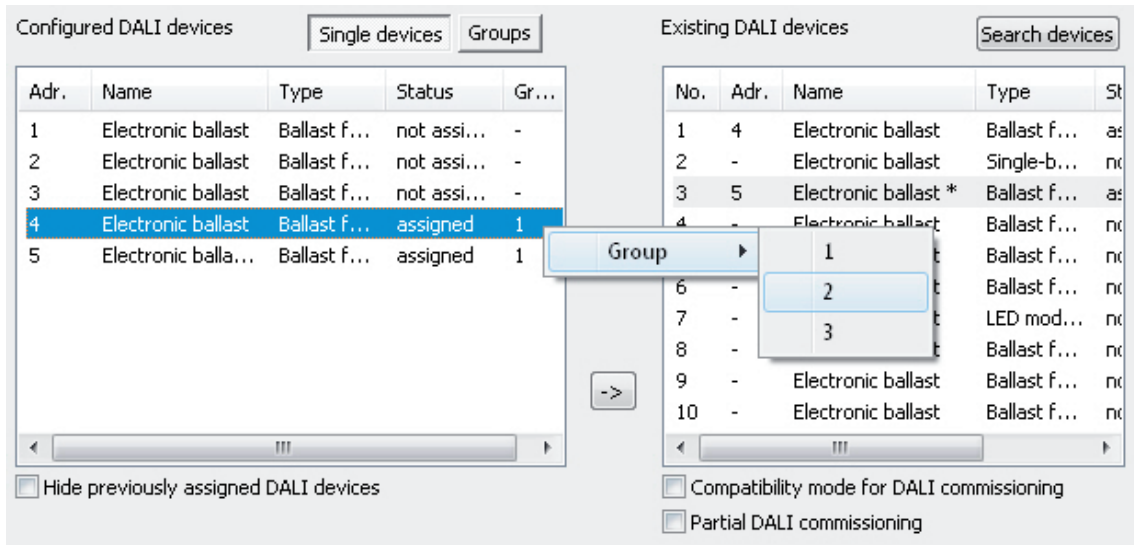

Figure 70: Directly moving assigned devices to another group

It is only possible in the "Single devices" view to move devices directly to other available groups via the context menu. In the "Groups" view, it is possible to move groups of devices using the **Cut** and **Paste** commands as an alternative (figure 71). To do this, first cut out devices in the original group and then select the target group. Afterwards, in the target group you can add the devices previously cut out via the context menu.

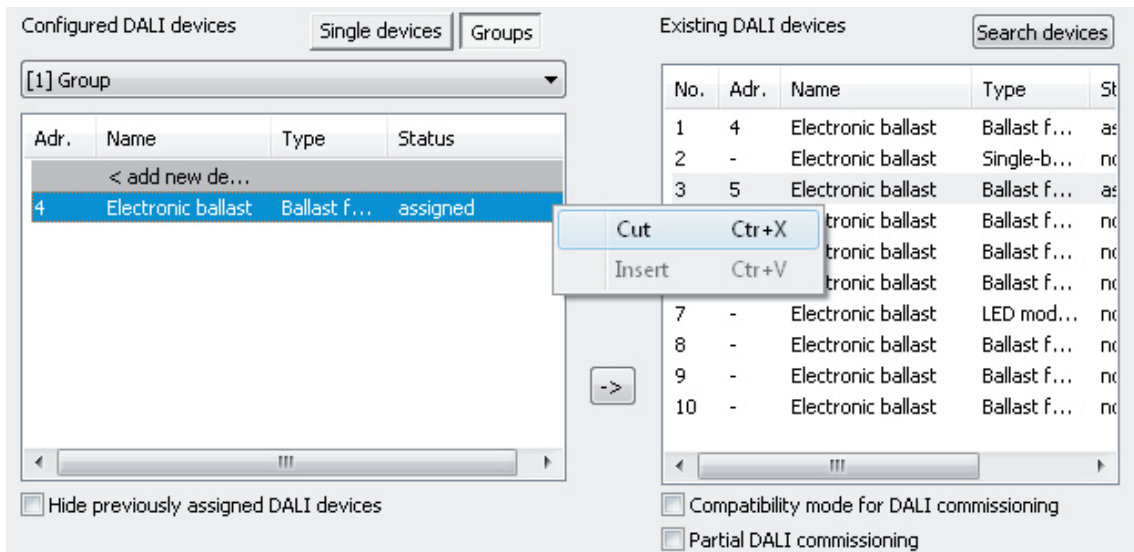

Figure 71: Moving assigned devices to another group by cutting and pasting

- i** When moving devices via the context menu, no multiple assignment to multiple groups is carried out, regardless of whether the checkbox "Hide previously assigned DALI devices" is enabled or disabled. When moving, the selected devices in the original group are cut out and pasted in the target group.
- i** Single devices that are not assigned to any groups (single addressing) cannot be moved to groups using the context menu.

Assigning single devices

As an alternative to the assignment of electronic ballasts to groups, it is possible to assign them to the devices of single addressing. The following sections document the individual actions to be taken to create a single device assignment in the DALI commissioning environment.

- i** The assignment of DALI operating devices to single devices is only then possible when the addressing type allows for device control.

Assignment also takes place for single-addressed devices by moving the devices listed in the right-hand section into the left-hand section (view of all single devices). Assignment is carried out by pressing the <- button between the two sections, or alternatively, by "drag and drop" with the mouse. An assignment can be removed again by selecting an assigned operating device and, using the -> button or the mouse, shifting it back to the list box of available DALI devices.

In contrast to the assignment of electronic ballasts to groups, it is not possible to assign multiple operating devices simultaneously or to remove them from an assignment. Each electronic ballast to be assigned requires a created single device in the Gateway project design so that the device name, the short address and, optionally, the DALI device type can be configured. In order to create an assignment, a created single device not previously assigned (status "Not assigned") must first be highlighted. After this, a found electronic ballast can be assigned to this single device using <-. Alternatively, assignment with the "drag and drop" function using the mouse is possible.

Single devices can be deleted using the **Del** button on the PC keyboard and thus removed from the Gateway project design. The assignments to found electronic ballasts are also lost as a result. The same applies if a single device is deleted in the configuration independently of the DALI commissioning dialog. In both cases, the plug-in warns of losing assignments.

- i** DALI operating devices can either be integrated only in single device addressing, or alternatively, in group addressing. It is not possible to control an operating device with both addressing types. Operating devices integrated in group control can no longer be addressed as a single device. The reverse case applies in the same manner.

- In the left-hand section of the DALI commissioning environment, open the single device view and highlight the single device to be added to a found operating device.
- Then assign a found electronic ballast using <- or, alternatively, by "drag and drop" function using the mouse.

In the right-hand section, the assigned operating devices disappear from the list box. The status of the selected single device in the left-hand subarea switches to "Assigned".(figure 72). The right-hand pane contains only the remaining, not yet assigned operating devices.

- i** If the checkbox "Hide previously assigned DALI devices" has been deselected in the Commissioning dialog of the plug-in, assigned electronic ballasts remain visible in the right-hand pane. Electronic ballasts assigned to programmed devices of the single addressing, cannot, however, be assigned to any other single devices (of the single or group addressing).

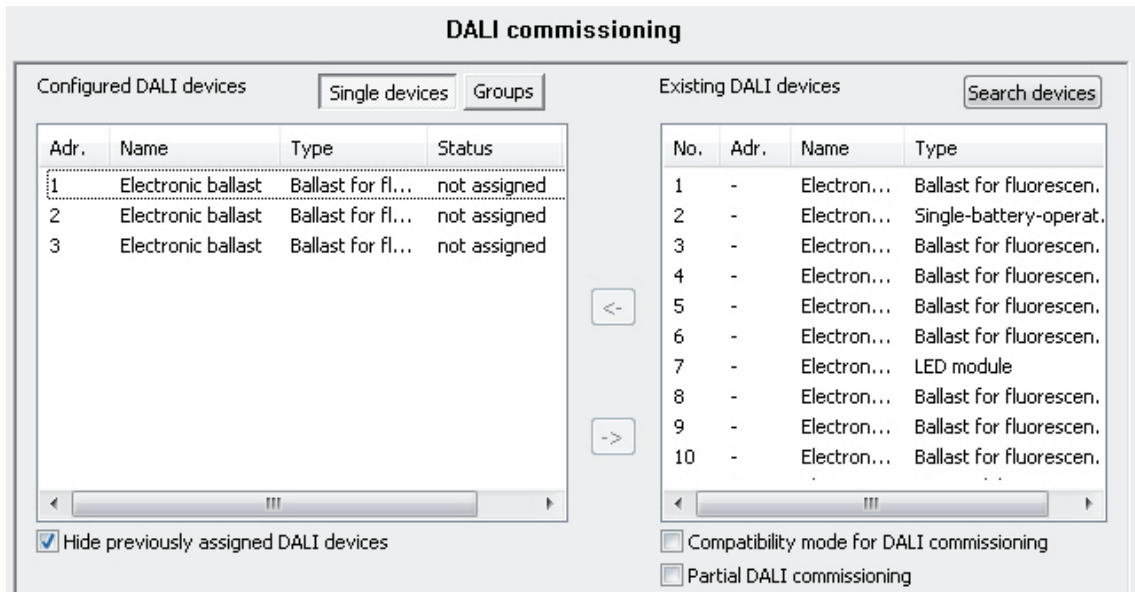

Figure 72: Operating device assigned to a programmed single device

- Reassign one of the remaining DALI operating devices to another programmed single device.

In the right-hand section, the assigned operating device disappears from the list box. The status of the selected single device in the left-hand subarea switches to "Assigned".

- Carry out assignments for other single devices as described if necessary.

- i** Pressing the **Delete assignment** button at the bottom edge of the commissioning environment allows deletion of all the assignments between the DALI operating devices and the various single devices of the project design. The operation may take some time. The progress is displayed during the Delete operation. Long and short addresses as well as other relevant parameters remain intact in the electronic ballasts.
- i** Pressing the **Standard** button deletes assignments of DALI operating devices to programmed single devices. Assignments of DALI operating devices are lost in the project design and in the DALI Gateway when the "Standard" button is pressed in the commissioning environment. The parameters of the DALI commissioning ("Hide previously assigned DALI devices", "Compatibility mode for DALI commissioning" and "Partial DALI commissioning") are not reset here to the Standard configuration". These parameters always remain at the states last set.

Optionally, the assignment of DALI operating devices to programmed single devices can be supplemented by testing of the DALI device types. If testing is enabled, the plug-in within the course of an assignment during online commissioning compares the device types determined by the operating devices with the specifications by the device type parameters of the offline configuration. Assignment can only take place if there is agreement. This will prevent functional incompatibilities after commissioning. The testing of the device types is influenced by the "Use 'DALI device type' setting ?" parameter in the parameter node "General".

Compatibility mode

The DALI Gateway has a compatibility mode for supporting non-DALI-conformant operating devices. This means that the commissioning process can become distinctly more tolerant towards specific DALI commissioning parameters, which means that operating devices not fully

compliant with the DALI specification can be commissioned, possibly subject to functional restrictions. Compatibility mode relates solely to DALI commissioning.

Compatibility mode is activated when the checkbox "Compatibility mode for DALI commissioning" (D) is selected in the DALI commissioning window of the ETS plug-in.(figure 63).

When compatibility mode is active, DALI operating devices in the system are no longer identified using their previously programmed long address. Normally (when compatibility mode is deactivated), the Gateway uses the DALI long address to check if found operating devices were previously commissioned in a search operation (known device), or whether this is a newly-found electronic ballast. When the Gateway carries out a search operation for DALI operating devices, the long address is automatically assigned randomly and is programmed into the electronic ballast. The long address is unique, thus allowing individual identification of operating devices.

According to the DALI specification, all the DALI subscribers must save the long address permanently (e.g. even during mains voltage failures). Not all the DALI devices on the market support this requirement, which is why difficulties may occur during the commissioning process. If long addresses are lost, the Gateway will no longer be able to identify clearly whether found electronic ballasts are known, i.e. already commissioned in previous commissioning operations, or whether they are newly-installed and are thus newly-found electronic ballasts. In these cases, operating devices are simply identified as "newly-found". As a result, during the remainder of the commissioning process, the affected electronic ballasts are treated like unprogrammed devices. Amongst other things, all the assignments to groups or single devices are removed.

If operating devices are installed in the DALI system, which do not comply with the DALI specification - as described - and do not save the long address correctly, compatibility mode should be activated. During a search operation, the Gateway then identifies solely by means of the DALI short address (1...64) contained in the devices. This address was either programmed during a previous commissioning operation by the Gateway, in accordance to the project design, or was assigned automatically during a search operation (new electronic ballast). This means that electronic ballasts can be commissioned without accessing long addresses.

i The identification of operating devices becomes problematic if devices are added to the DALI installation at a later time, which were commissioned previously (e.g. in other systems) and thus have already been assigned with valid short addresses. Here, it may occur that different electronic ballasts have the same short address. This state must be avoided when using compatibility mode, since short addresses may only occur once in a DALI installation. Otherwise, communication errors can be expected.

All the commissioning parameters transferred from the gateway are required for correct, fault-free operation of the DALI system and must correspond to the DALI specification. During online commissioning, it may occur that all or some electronic ballasts do not apply the commissioning parameters transferred from the Gateway partially or completely. In order to detect this, the gateway in normal operation checks (compatibility mode deactivated) each programmed change by reading it out and compares the return value of the operating devices with the specifications in the project design (DALI verify). If differences are detected here among short addresses or group assignments to be programmed, the plug-in signals an error.

DALI operating devices that could only be programmed with errors during the online commissioning can work according to their function after commissioning is complete. These DALI operating devices possibly do not comply or only partially comply with DALI, however. If commissioning errors occur repeatedly, the compatibility mode can be activated on an experimental basis. In compatibility mode the DALI gateway does not read back the programmed commissioning parameters during an online commissioning. Operating devices which merely dispense with answering the gateway (DALI verify remains off / but the function is available), can be commissioned in this way without any error display and abort of the programming connection.

If short addresses of the electronic ballasts change due to parameterisation or new assignments, the DALI gateway reprograms the addresses in the existing electronic ballasts. If compatibility mode is deactivated, short addresses are changed by deleting the old one and recording the new address. In rare cases, operating devices do not respond correctly to the

deletion of a short address. If the compatibility mode is activated, the short addresses is therefore not deleted. In this case, the gateway simply programs the new address over the old one. Even in such cases, the compatibility mode helps to commission operating devices smoothly that are not DALI-compliant.

4.2.4.7.3 Exiting DALI commissioning

Commissioning can be completed when the necessary DALI operating devices have been assigned to the groups or single devices in the plug-in. The commissioning parameters are transferred to the DALI Gateway automatically on leaving commissioning. In so doing, the plug-in communicates with the DALI Gateway via the ETS bus connection. The DALI Gateway must be connected to the KNX bus cable and the bus and mains voltage supply must be switched on. The ETS must have a functioning communications interface to the bus (e.g. USB or KNXnet/IP).

Exiting DALI commissioning

- The commissioning environment of the plug-in must be exited in order to transfer the commissioning parameters to the DALI Gateway and the operating devices. To do this, select a different parameter page in the tree node view of the plug-in and exit the plug-in by pressing the button **OK**.

The commissioning adjustment is executed. The adjustment operation can take some time and is dependent on the number of groups and single devices created and the DALI operating devices connected. Firstly, the plug-in programs the Gateway with the programmed short addresses. The plug-in displays the progress of this adaptation.(figure 73).

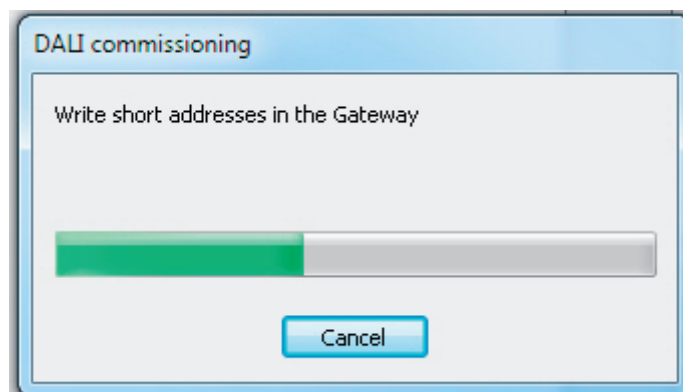

Figure 73: Adjustment of the commissioning parameters between the plug-in and the DALI Gateway.
Here: Programming the short addresses

After the short addresses have been updated in the DALI Gateway, the connected DALI operating devices are also updated in this regard. To do this, the Gateway communicates with the connected operating devices via the DALI cable and programs them fully automatically.(figure 74).

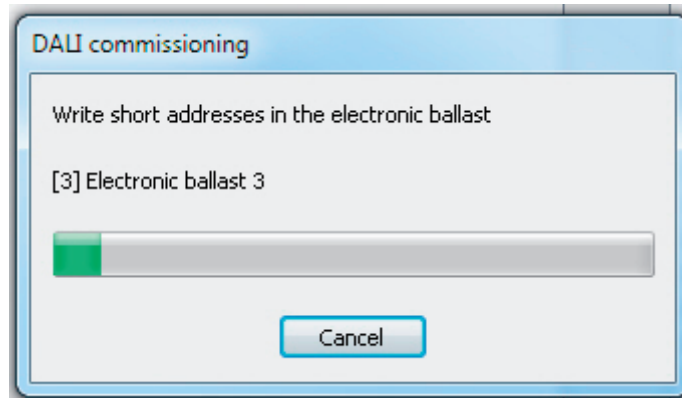

Figure 74: Adjustment of the commissioning parameters between the Gateway and the DALI operating devices.
Here: Programming the short addresses

After the short addresses have been programmed, the group assignments are updated. This takes place in two steps. Firstly, the group assignments are programmed into the DALI Gateway. Then they are programmed into the electronic ballasts via the DALI cable.

- i** The ETS plug-in always performs DALI commissioning in a time-optimised manner and only programs the necessary changes into the Gateway and the DALI operating devices. For this reason, some or all of the individual commissioning steps (programming of group assignments or short addresses) may not be necessary. Should commissioning be terminated in an incomplete state due to communication or device errors, the ETS plug-in will perform a complete programming operation during a subsequent commissioning adjustment. Here too, the adjustment of DALI commissioning must be initiated manually in the ETS plug-in, as described.
- For the full completion of commissioning and to apply all the necessary parameter settings, close the plug-in and then program the application of the DALI Gateway using the ETS.
- i** The Gateway checks the function of the DALI cable during the programming of the commissioning parameters into the DALI operating devices. Should no communication be possible, the plug-in will terminate the incomplete operation with an error message. In this case, the error on the DALI cable (e.g. electronic ballast disconnected, mains voltage switched off, cable break) must be eliminated and the commissioning environment of the plug-in opened and exited again in order for a new commissioning adjustment to take place.

During the programming of the commissioning parameters into the Gateway, fault-free communication between the ETS plug-in and the Gateway must be ensured via the KNX. If the plug-in cannot reach the device, the incomplete commissioning operation is then terminated. In this case too, the error must be eliminated and the commissioning environment of the plug-in opened and exited again in order for a new commissioning adjustment to take place.

- i** All the commissioning parameters transferred from the gateway are required for correct, fault-free operation of the DALI system and must correspond to the DALI specification. During online commissioning, it may occur that all or some electronic ballasts do not apply the commissioning parameters transferred from the Gateway partially or completely. In order to detect this, the Gateway checks each programmed change by reading it out and compares the return value of the operating devices with the specifications in the project design (DALI verify).
If differences are detected here among group assignments that are to be programmed, the gateway logs the error internally and then continues the commissioning operation with the next electronic ballast and also completes this one. At the end of the online commissioning adjustment, the plug-in displays a message listing all the electronic ballasts to which group assignments could not be programmed successfully during commissioning.
If the gateway detects differences among short addresses to be programmed, it terminates the commissioning immediately with an error message. Short addresses are absolutely essential for the operation of a DALI system. If commissioning errors occur here, the gateway cannot ensure smooth operation of the DALI installation. Consequently, it is then necessary to abort the online commissioning.
DALI operating devices that could only be programmed with errors during the online commissioning can work according to their function after commissioning is complete. These DALI operating devices possibly do not comply or only partially comply with DALI, however. Please contact the manufacturer of the electronic ballasts concerned to clarify any functional incompatibilities.
If commissioning errors occur repeatedly, the DALI compatibility mode can be activated on an experimental basis (see page 175). In compatibility mode the DALI gateway does not read back the programmed commissioning parameters during an online commissioning. Operating devices which merely dispense with answering the gateway (DALI verify remains off / but the function is available), can be commissioned in this way without any error display and abort of the programming connection.
- i** When the commissioning environment is exited, the commissioning parameters (identified operating devices with long and short address, names of the operating devices, group/device assignment and device type) are written to the ETS database and are thus saved. The saved data is displayed the next time the commissioning environment is started.
- i** If just assignments of programmed devices of the single addressing (i.e. no group assignments) are removed and no short addresses are changed during a commissioning session, then no adjustment will be performed between the ETS plug-in, the Gateway and the operating devices when the commissioning environment is exited. This means that the most-recently programmed short addresses are retained in the electronic ballast (unused short addresses). In the case of a new commissioning operation, however, the affected electronic ballasts can again be assigned and commissioned normally.
- i** Pressing the **Delete assignment** button at the bottom edge of the commissioning environment allows deletion of all the assignments between the DALI operating devices and the various groups and single devices. Not only are the assignments reset in the plug-in, but there is also an adjustment of the commissioning parameters of the DALI Gateway. For this purpose, the plug-in sets up communication to the DALI Gateway via the bus connection of the ETS and deletes all the assignments in the device memory there. The operation may take some time. The progress is displayed during the Delete operation. If the bus communication is faulty, the plug-in terminates the operation without deleting the assignments in the project design or in the device. Previously identified DALI operating devices remain intact, but without group/device assignments.

4.2.4.7.4 Offline commissioning

The identification, addressing and assignment of DALI operating devices takes place in the DALI commissioning environment of the ETS plug-in. Commissioning can be prepared offline in the parameter configuration if necessary. Offline commissioning is ideal as the preparation for later complete commissioning, if there is no programming connection to the DALI Gateway or the DALI operating devices, but group assignment is still to take place. This is normally the case when the building planning and thus also the Gateway configuration take place earlier than the commissioning of the DALI Gateway and the DALI system.

The offline assignment of an electronic ballast to a group takes place in the plug-in in the tree node "Addressing -> Groups... -> Group -> Single devices" by clicking the right mouse-button and executing the **New** command.(figure 75). This creates a new electronic ballast in the selected tree node. This electronic ballast is then assigned to the group addressing of the selected group. Additional parameters can be configured for each operating device created and assigned in this way (name, short address and, optionally, the device type). Single devices assigned to a group do not have their own communication objects. On the KNX side, these devices are only controlled by the objects of the group. Only single devices assigned during project design of the single addressing (device control) can be controlled autonomously using separate objects.

- i** The assignment of DALI operating devices to groups is only then possible when the addressing type allows for group control.

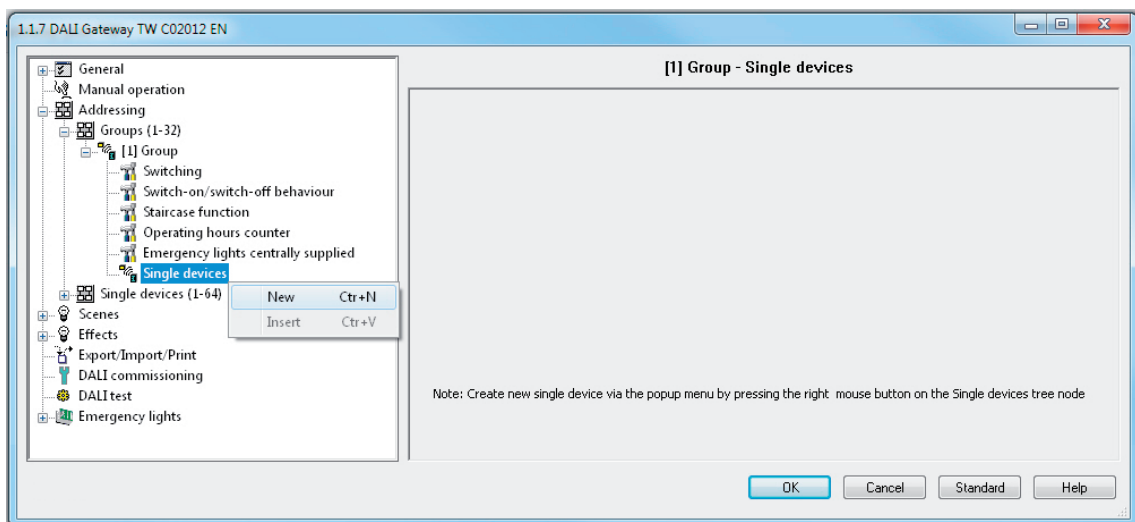

Figure 75: Assigning an electronic ballast to a group - offline commissioning

- i** DALI operating devices can either be integrated just in single addressing, or alternatively, in group addressing. It is not possible to control an operating device with both addressing types.
- i** Optionally, the assignment of DALI operating devices to programmed groups or single devices can be supplemented by testing of the DALI device types. If testing is enabled, the plug-in within the course of an assignment during online commissioning compares the device types determined by the operating devices with the specifications by the device type parameters of the offline configuration. Assignment can only take place if there is agreement. This will prevent functional incompatibilities after commissioning.
- i** Multiple assignment of operating devices as part of offline commissioning (creation of new single devices in the tree structure of a group) is not possible. When editing the short address in the parameter node of a group-related electronic ballast, no addresses can be entered that have already been entered for electronic ballasts of other groups.

- i** The DALI short addresses are always assigned in the parameter configuration of the single devices and can thus be influenced. With the addition of group and device names, unique naming of DALI operating devices is possible in this way. Through the transmission of the unique names to the KNX building visualisation (e.g. control panels), the user is able - particularly during error diagnosis - to identify the lighting components easily.

Copying and moving devices

Devices assigned to groups during the offline commissioning can be copied and pasted to the same group or to other groups as a new device via simple commands if necessary. Alternatively, it is also possible to paste other existing devices. The electronic ballast name of a copied device can be transferred to other existing devices or new devices by copy and paste. Devices can also be cut out and pasted into groups if necessary. This allows devices to be moved easily from selected devices into other groups during the offline commissioning. Just like devices in groups, individually addressed devices can be copied and pasted as a new device or copied and pasted to an existing device of the single addressing. Here, all parameters of the copied device are transferred to other existing devices or to new devices, which means that the project design, especially of devices with the same functions, is greatly simplified.

The commands for copying (group-addressed and individually addressed devices) and cutting out (only group-addressed devices) are available if a devices in the tree node "Addressing -> Groups... -> Group -> Single devices or "Addressing -> Single devices..." is selected and then opened by right-clicking on the context menu (figure 76).

The command for pasting is available in the same way when the target of the paste operation (an existing device or subordinate node) is selected.

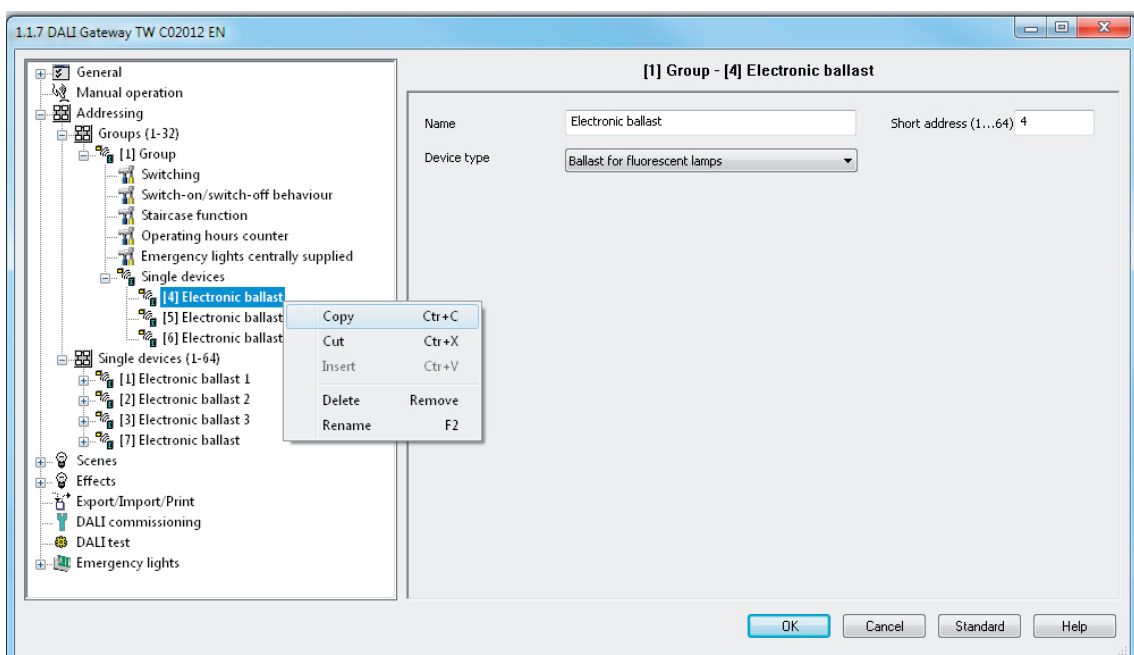

Figure 76: Commands in the context menu for copying, cutting out and pasting devices

- i** When copying or cutting out, the short address of the selected device is not included in the copy or in the moved device. When pasting, the next free short address of the available address range (1...64) is created. For this reason and because of the changed group assignment, even assignments to DALI operating devices found (online commissioning) will then be lost!

- i** As an alternative to moving a group-addressed device via the context menu (cutting and pasting), devices can also be moved between groups by "drag and drop" with the mouse. In contrast to moving via the commands of the context menu, the short addresses of the devices are retained when moving with the mouse. Owing to the changed group assignment, even assignments to DALI operating devices found (online commissioning) will be lost here, too!
- i** Devices that are copied or cut out can also be pasted multiple times.
- i** It is not possible to paste devices from the group assignment into an individually addressed device or into the individually addressed area. It is not possible to paste or move an individually addressed device into the group area either.

4.2.4.7.5 Troubleshooting

KNX communication error

During the online commissioning, the short addresses of the electronic ballasts and group assignments are programmed into the gateway and DALI operating devices. For this purpose, the plug-in establishes a programming connection to the DALI gateway via the active data interface of the ETS. In the later course, the gateway establishes a programming connection to the DALI operating devices.

During the programming of the commissioning parameters into the Gateway, fault-free communication between the ETS plug-in and the Gateway must be ensured via the KNX.

If the plug-in cannot reach the DALI gateway via the KNX programming connections of the ETS, the incomplete commissioning operation is then aborted immediately. The plug-in then displays an error (figure 77). In this case, the error must be removed and the DALI commissioning must be repeated.

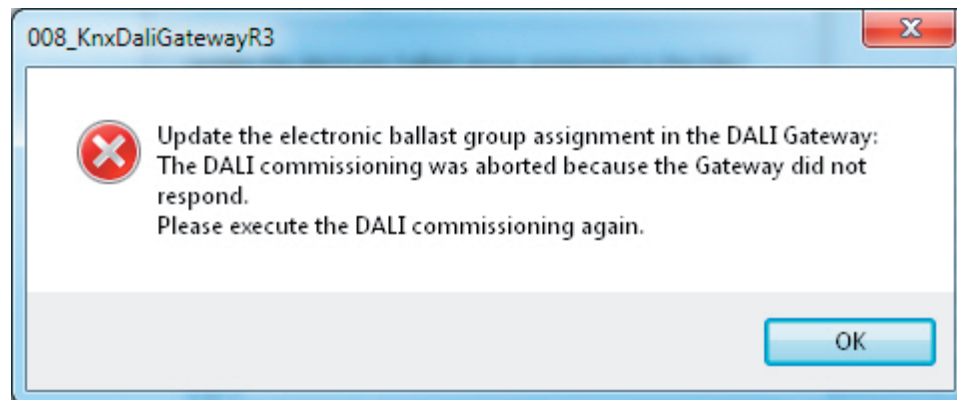

Figure 77: KNX communication problem error message

Errors with the KNX communication during DALI commissioning are normally due to redundant telegram repetitions or wrong telegram sequences. Other bus devices or ETS installations on PC, which are utilized to capacity with regard to the available memory and/or processor resources, are frequently the cause here. In the event of a error, area couplers or line couplers are normally available in the KNX installation.

If the described communication errors occur in a KNX system, the configuration of the area coupler or line coupler should be changed temporarily as a remedy. Switching off the telegram repetitions in the event of transmission errors in the couplers frequently allows KNX communication to take place smoothly between the ETS and gateway.

Recommended Procedure...

- Reconfiguration of all area / line couplers affected. Couplers are affected when they are directly in the lines of the ETS and DALI gateways or in the communication channel between them.
Switching off the telegram repetitions by the couplers. To do this, set the coupler parameters "Repetitions in case of transmission errors..." of all addressing types to "no". These parameters are normally set to "yes" in the presetting of the couplers.
Programming the application program of the couplers.
 - Executing the DALI commissioning using the plug-ins of the gateway.
 - After completion of the DALI commissioning, reset the parameters "Repetitions in case of transmission errors..." of all addressing types in all couplers affected to the original setting (normally to "yes").
Programming the application program of the couplers.
- i** The telegram repetitions should also then be switched off temporarily when communication between the ETS and DALI gateway does not take place across all lines.

- i** It should be noted that the normal operation of area / line couplers is interrupted for the duration of the programming operation due to the programming of the particular application program or parameters and thus no telegrams are forwarded. The function of a KNX system could be temporarily impaired as a result.

If it is not possible to eliminate the KNX communication problem permanently by the described remedy, the DALI side of the gateway must be checked for installation errors. Line breakages that may only occur sporadically can occasionally produce the same error messages. The entire cable, including all terminals and connections, must then be checked.

Error during the programming of the commissioning parameters

All the commissioning parameters transferred from the gateway are required for correct, fault-free operation of the DALI system and must correspond to the DALI specification. During online commissioning, it may occur that all or some electronic ballasts do not apply the commissioning parameters transferred from the Gateway partially or completely. In order to detect this, the Gateway checks each programmed change by reading it out and compares the return value of the operating devices with the specifications in the project design (DALI verify).

If differences are detected here among group assignments that are to be programmed, the gateway logs the error internally and then continues the commissioning operation with the next electronic ballast and also completes this one. At the end of the online commissioning adjustment, the plug-in displays a message listing all the electronic ballasts to which group assignments could not be programmed successfully during commissioning.(figure 78).

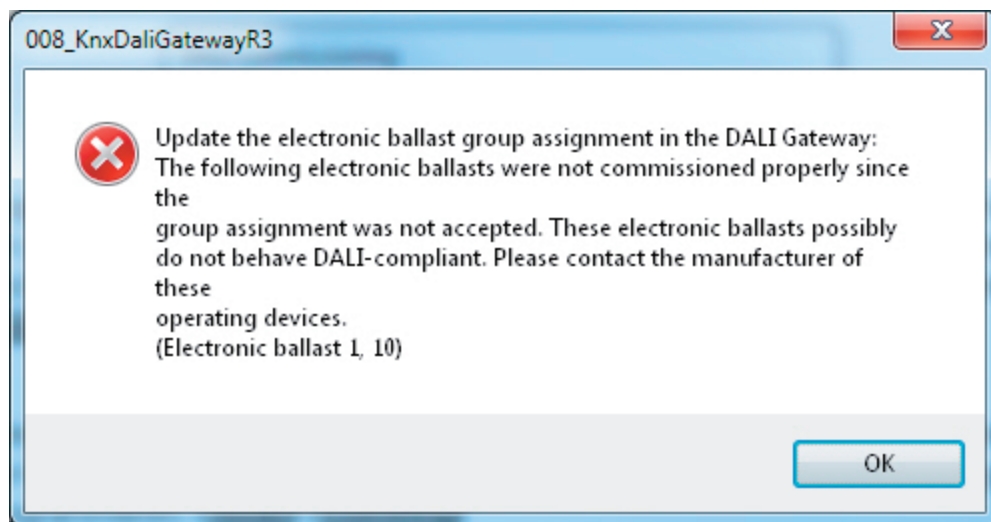

Figure 78: Error message of DALI group assignment

DALI operating devices that could only be commissioned with the described errors can still work according to their function after commissioning is completed in some cases. These DALI operating devices possibly do not comply or only partially comply with DALI, however.

If commissioning errors occur repeatedly, the "Compatibility mode for DALI commissioning" can be activated as a remedy. In compatibility mode the DALI gateway does not read back the programmed commissioning parameters during an online commissioning. Operating devices which merely dispense with answering the gateway can be commissioned in this way without any error display.

- i** If the gateway detects differences among short addresses to be programmed, it terminates the commissioning immediately - even in compatibility mode - with an error message. Short addresses are absolutely essential for the operation of a DALI system. If commissioning errors occur here, the gateway cannot ensure smooth operation of the DALI installation. Consequently, it is then necessary to abort the online commissioning.

- i** If the described DALI commissioning faults occur permanently, a DALI reset should be performed using the plug-in ("Reset" button in the commissioning dialogue). As a result, all DALI operating devices will be reset to the delivery states defined by the manufacturers. In this operation, all the assignments to groups and single devices in the electronic ballasts are removed. Furthermore, the long and short addresses in the operating devices are deleted.

If it is not possible to eliminate the error message permanently by the compatibility mode, the DALI side of the gateway must be checked for installation errors. Line breakages that may only occur sporadically can occasionally produce the same error messages. The entire cable, including all terminals and connections, must then be checked.

4.2.4.8 DALI test

Starting DALI test

The plug-in of the DALI Gateway offers various options for carrying out a comprehensive test of the DALI installation. This means that after DALI commissioning, it is possible to control individual operating devices in a device-orientated test, to switch them and to read out or specify brightness values or colour temperature values. The individual device status can also be displayed. In the group-orientated test, all the created DALI groups (1...32) can be switched separately, changed in the brightness value or in the colour temperature (if supported by the operating device). In addition, it is possible to check the function of the configured scenes (1...16) and effects (1...16).

The DALI test can only be performed if the device, group, effect and scene configuration in the DALI Gateway remains current after DALI commissioning or parameters are changed. For this reason, it is necessary to program the DALI Gateway with the ETS before a DALI test if changes were previously made to the device configuration (see page 13).

If the necessary requirements have been fulfilled, the "DALI test" can be executed on the parameter page of the same name in the plug-in. After selecting the test page and successful communication with the DALI Gateway, the commissioning environment becomes visible in the right-hand pane of the plug-in.

- i** In the course of a DALI test, only broadcast commands (switch all devices) can be issued, provided that addressing allows for central control.

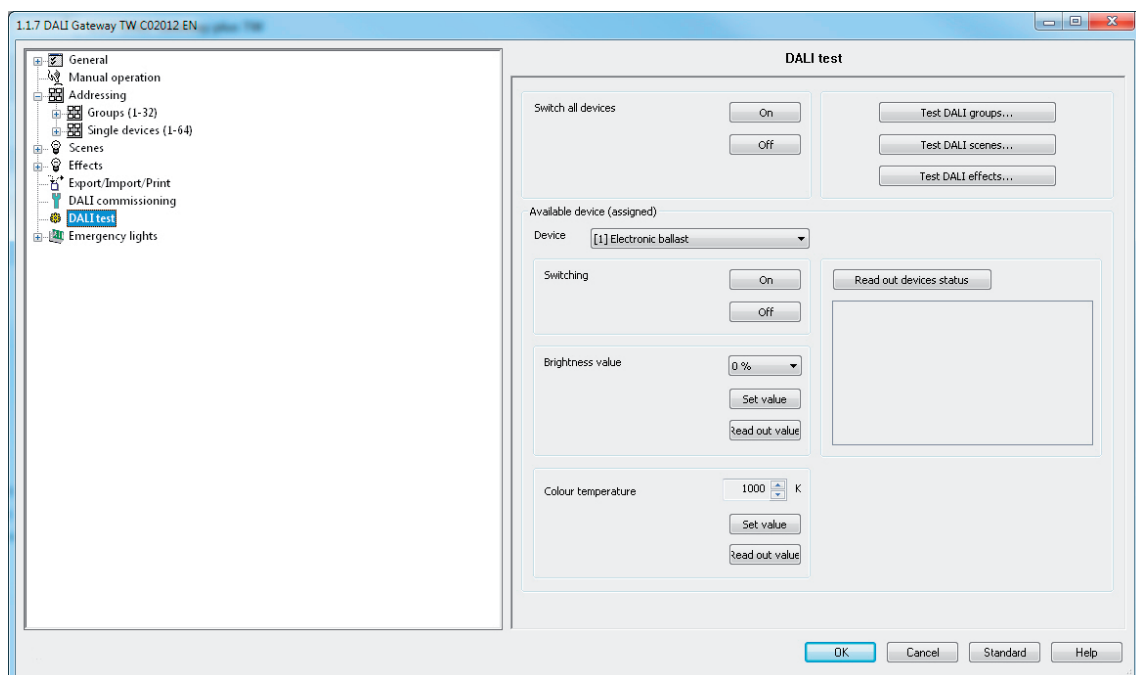

Figure 79: DALI test environment in the ETS plug-in

When the test environment is recalled, the plug-in first tries to communicate with the ETS via the bus connection, and checks whether a DALI test is possible. For this reason, the DALI Gateway must be connected to the KNX bus cable and the bus and mains voltage supply must be switched on when the DALI test is recalled. In addition, the ETS must have a functioning communications interface to the bus (e.g. USB or KNXnet/IP).

If it is not possible to set up a connection to the DALI Gateway in this situation, the plug-in then terminates the test and does not display the test environment. The following section lists the causes for a faulty connection and the appropriate remedies...

- Cause: No functioning ETS communication interface to the KNX.
Remedy: Check, and if necessary, setup the connection in the ETS.

- Cause: Physical address and application program not previously programmed by the ETS.
Remedy: Close the plug-in and first program the physical address and application program.
- Cause: KNX bus voltage on the DALI Gateway or the local data interface not connected or switched on.
Remedy: Connect and switch on the bus voltage.
- Cause: Mains voltage supply on the DALI Gateway not switched on.
Remedy: Switch on the mains supply on the Gateway.

Device-orientated DALI test

As soon as DALI commissioning has taken place, and operating devices have thus also be identified and assigned, the correct function of these devices can be tested in the device-orientated DALI test. The device-orientated test environment is used for this.(figure 80).

Figure 80: Device-orientated DALI test environment

The operating device to be tested must first be selected in the "Device" selection box. This contains all the identified and assigned DALI operating devices - indicated by the individual short address in square brackets and the device name. Only one device can be tested at a time. The selected operating device can then be switched on or off independently. In addition, it is possible to specify an absolute brightness value or colour temperature value. Pressing the "Set value" button in the "brightness value" area transmits the brightness value selected in the selection box to the appropriate operating device, which should then set itself immediately to this brightness value. The brightness value is independent of a configuration for minimum or maximum brightness. The whole brightness range can thus be set in the device-orientated DALI test. Similarly, the currently set brightness value of the DALI operating device can be polled by pressing the "Read out value" button in the "brightness value" area. The read-out value is displayed in the selection box above.

As with the brightness test of a DALI operating device, the colour temperature in the selection box is transmitted to the corresponding operating device when the "Set value" button is pressed in the "colour temperature" area. The electronic ballast should then adjust itself immediately to the specified colour temperature, but only if the luminaire is also switched on. The colour

temperature value is independent of a configuration for the minimum or maximum colour temperature. Thus, the entire colour temperature range can also be set here in the device-orientated DALI test. Similarly, the currently set colour temperature value of the DALI operating device can be polled by pressing the "Read out value" button in the "colour temperature" area. The read-out value is displayed in the selection box above.

- i** When predefining a colour temperature value, the set brightness value in the test environment for the electronic ballast is always transmitted to the operating device as well. During the transmission of a colour temperature with the brightness value "0 %", the operating device does not normally show any reaction.
- i** It is only possible to specify or read out a colour temperature for operating devices that support the DALI device types "Colour Control" (DALI Device Type 8) in the specific version "Tunable White (TW)". Other operating devices ignore the specifications and do not respond to the reading out of the current colour temperature. The plug-in displays an error message if a colour temperature is read out from an electronic ballast that this function does not support.
The "colour temperature" area is only available in the device-oriented DALI test if the tunable white lights are integrated under "General".

By pressing the button "Read out device status", it is possible to display the internal device states. In this way, the general device status (operating device error, e.g. internal electronic ballast error), lamp state (e.g. defective lamp, cable break to lamp holder), current switching state, reset status and status of the mains voltage supply of the operating device can be read out and displayed.

- i** The status information of a reset or mains voltage failure is dependent on the DALI operating device used. Not all devices track these states.
- i** An error on the DALI cable (e.g. short-circuit or interrupted cable) is only recognised by the Gateway during the device-orientated DALI test when information is to be read out of the operating devices (read out value or device status). The plug-in then signals an error.
- i** During the device-orientated DALI test, the commands are transmitted to the operating devices directly via the DALI cable. No group assignments or assignments to single-addressed devices are taken into account, which means that group/device objects cannot be tracked during the test and thus differences may occur between the objects and the actual states of the operating devices.

Multi-device DALI test (broadcast)

As soon as DALI commissioning has taken place, and operating devices have thus also be identified and assigned, the correct function of these devices can be tested in the multi-device DALI test. For this purpose, the devices can jointly be switched on or off using a broadcast switching command.(figure 81).

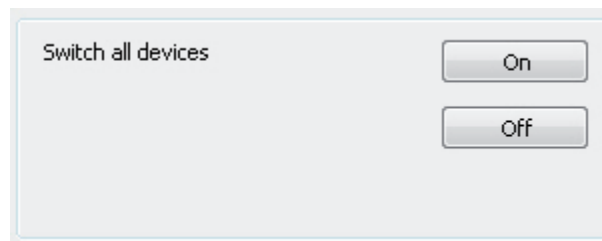

Figure 81: Multi-device DALI test environment

- i** An error on the DALI cable (e.g. short-circuit or interrupted cable) is not recognised during the multi-device DALI test.

- i** During the multi-device DALI test, the commands are forwarded to the operating devices directly using the DALI cable. No group assignments or assignments to single-addressed devices are taken into account, which means that group/device objects cannot be tracked during the test and thus differences may occur between the objects and the actual states of the operating devices.

Testing groups

The group-orientated DALI test can be carried out as soon as groups have been created and configured in the device configuration and DALI commissioning has been carried out with the group assignment of the operating devices. To do this, press the button "Test DALI groups" in the DALI test environment. The group-orientated test environment then opens. (figure 82).

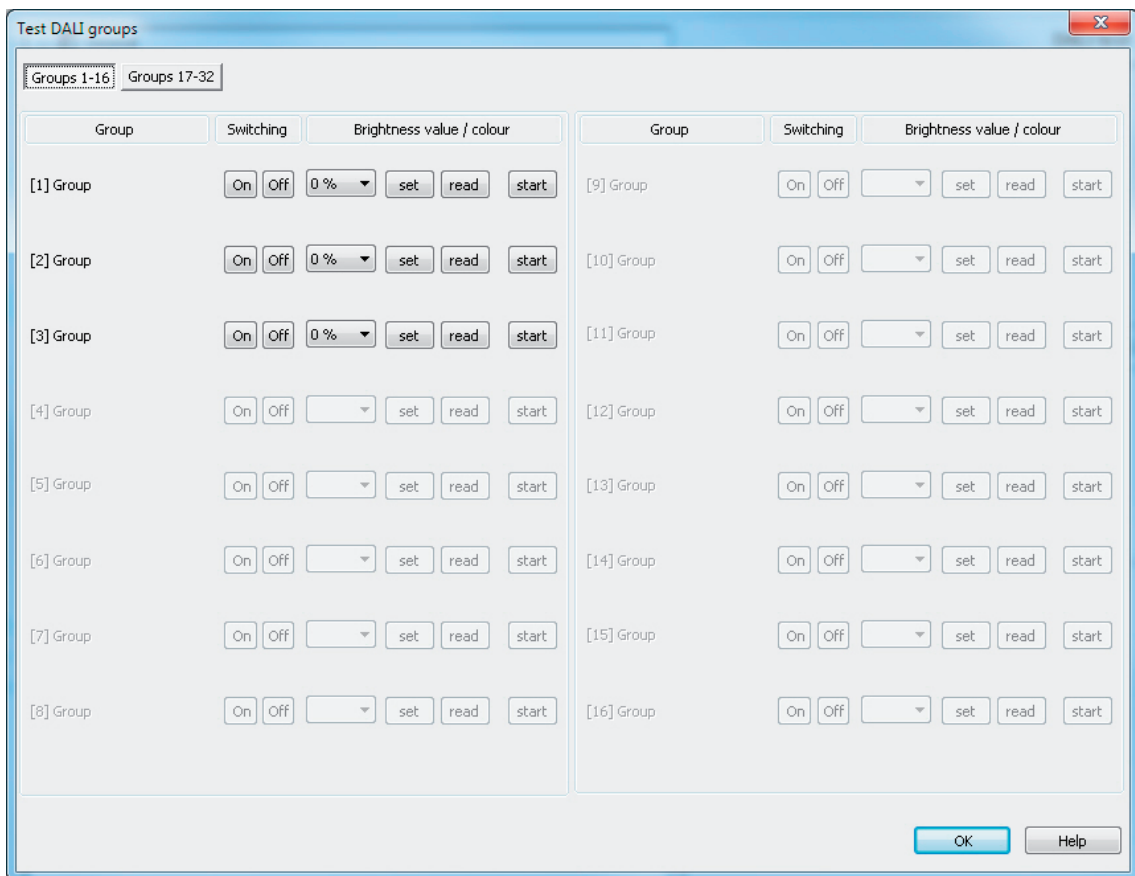

Figure 82: Group-orientated DALI test environment (as an example with three created groups)

For reasons of clarity, the possible groups (1...32) are spread over two pages, which can be shown separately. Pressing the buttons "Groups 1-16" and "Groups 17-32" at the top edge of the window changes between the page views. Only those groups which have been created in the device configuration can be set and thus tested. Any non-created groups are greyed out.

In the group-orientated DALI test, each group can independently be switched on or off, or dimmed absolutely or relatively. Pressing the buttons "On" or "Off" causes immediate switching of the operating devices assigned to the appropriate group.

Alternatively, an absolute brightness value can be specified, which can be transmitted to the operating devices of the group by pressing the button "Set" next to it. The brightness value is dependent on the group configuration for minimum or maximum brightness. Thus, it may occur that only a limited brightness range can be set in the group-orientated DALI test.

Similarly, the currently set brightness value of the group can be polled by pressing the "Read" button. The read-out value is displayed in the selection box alongside. Due to rounding, the

displayed value may deviate slightly from that most recently specified.

In addition, the operating devices of the group can be dimmed relatively. Pressing the "Start" button initiates a relative dimming operation of the group. The dimming operation takes place within the brightness range specified for the group using the configured dimming speed, starting with the currently set brightness value. A relative dimming operation can be stopped by pressing the "Stop" button. Reactivation of a dimming operation using the "Start" button causes dimming to take place in the reverse direction. Relative dimming to 0 % brightness (OFF) is not possible.

As with the brightness test of a DALI group, a colour temperature can also be tested group-oriented. When the "set" button is pressed, the colour temperature in the selection box next to it is transmitted. The group should then adjust itself immediately to the specified colour temperature, but only if the group is also switched on. Just like the brightness, the colour temperature value is dependent on the configuration for the minimum or maximum colour temperature of the relevant group. Thus, it might only be possible even here to set a limited colour temperature range in the group-orientated DALI test. Optionally, the currently set colour temperature value of the DALI group can be polled by pressing the "Read" button. The read-out value is displayed in the selection box of the colour temperature.

- i** A colour temperature value set in the group-oriented test environment is only ever transmitted to the DALI group if the group is switched on (brightness > 0 %). When setting a colour temperature in the "OFF" state (brightness value = 0 %), the operating devices do not show any reaction unless the group should switch on in the "OFF" state when predefining a colour temperature (configurable function of the group).
- i** The specification or reading out of a colour temperature only shows a reaction if operating devices are integrated into the group that support the DALI device types "Colour Control" (DALI Device Type 8) in the specific version "Tunable White (TW)". Other operating devices ignore the specifications and do not respond to the reading out of the current colour temperature. The "colour temperature" range is only available in the group-oriented DALI test if the tunable white lights are integrated under "General".
- i** An error on the DALI cable (e.g. short-circuit or interrupted cable) is not recognised during the group-orientated DALI test.
- i** In the group-oriented DALI test, operating devices of the group respond to the switching and brightness and colour temperature value specifications as stipulated in the configuration. All the actions are implemented internally using the appropriate KNX objects of the groups and individual devices. Thus, the internal object values can be read out, for example, when the brightness values are read out and the switching object described internally when a group is switched on. Here, feedback is also generated and the appropriate DALI group parameters included. If no operating device was assigned to the groups during DALI commissioning, there will be no visible reaction in the DALI system.
- i** DALI operating devices assigned to multiple groups always set themselves to the most recent status set using one of the assigned groups. In this case, feedback of the switching status, brightness value or colour temperature of a group cannot always be clear.
 Example 1: Group 2 is set to 10 % brightness. After this, Group 3 is dimmed to 20 % brightness. The lights of Group 3 assume the most recently recalled brightness value: 20 %. The feedback of Group 2 remains at 10 %, although some of the operating devices belonging to the group were set to 20 % brightness.
 Example 2: Group 2 is switched on and sets itself to the brightness value 100 %. The status of Group 3 internally in the DALI Gateway remains at 0 % brightness (OFF). Now Group 3 is made brighter. The lights of Group 3 adopt the dimming behaviour (becoming brighter from minimum brightness), although these lights have already been switched on by Group 2.

Testing scenes

The scene-orientated DALI test can be carried out once scenes have been created and configured in the device configuration and DALI commissioning has been carried out with the group/device assignment of the operating devices. To do this, press the button "Test DALI scenes" in the DALI test environment. The scene-orientated test environment then opens.(figure 83). Not only the groups and single devices integrated into the scenes can be

tested in the scene test. Of more importance is the fact that a scene definition is also possible through reading out and saving scene values.

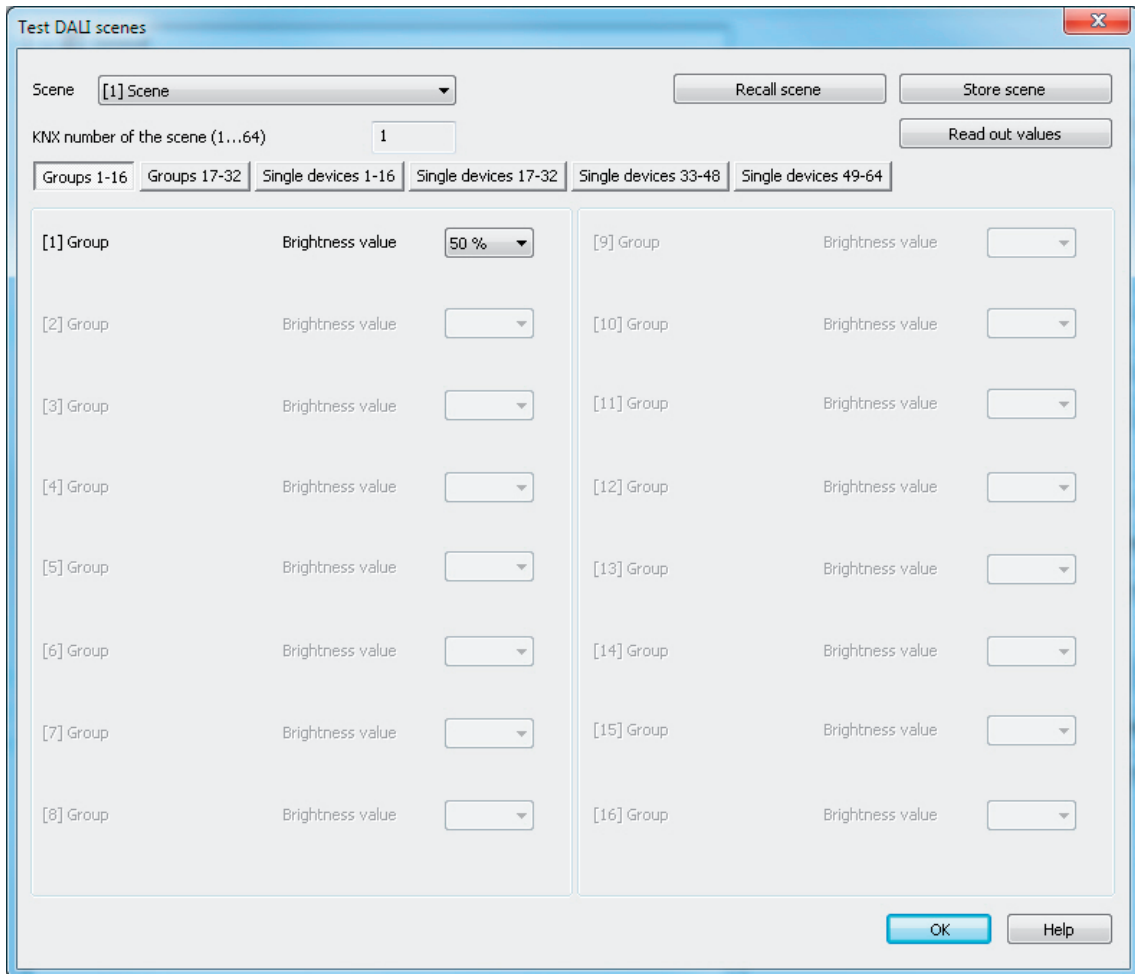

Figure 83: Scene-orientated DALI test environment (as an example with Scene 1 with three created groups)

The scene to be tested must first be selected. To do this, select one of the scenes created in the device configuration in the "Scene" selection box. After selecting the scene, the assigned groups and single devices can be edited. For reasons of clarity, the possible groups (1...32) and single devices (1...64) are spread over multiple pages, which can be shown separately. Pressing the buttons "Groups..." or "Single devices..." at the top edge of the window changes between the page views. Only the groups and single devices can be edited (and thus tested), which are assigned to the scene. Any non-assigned groups or single devices are greyed out.

When starting the scene-orientated DALI test, the predefined brightness values and colour temperature values (only when using the colour temperature control) in the scene configuration (parameter page "Scenes") are visible in the appropriate selection boxes. Pressing the button "Recall" scene causes a scene recall with the values predefined in the scene configuration. The set brightness values and colour temperature values in the group/device selection boxes of the test environment are not important.

The values specified in the test environment are only applied and saved to the scene configuration of the plug-in and the DALI Gateway when the button "Save scene" is pressed. The original values predefined in the scene configuration are overwritten.

Before new brightness values and colour temperature values are saved for a scene, it is possible to read out the values currently set in the groups and single devices. The read-out values are displayed in the selection boxes and can be edited and finally saved in the scene.

- i** The test functions for the colour temperature are only available if integration of the tunable white lights is provided under "General". If the colour temperature control is used globally, the plug-in always displays test functions for the colour temperature for all groups and single devices in all scenes, too. This is displayed even if no colour temperature control at all is provided in the groups or single devices (e.g. in the case of DALI device types that do not even allow any colour temperature control). In such cases, the colour temperature specifications in the scenes are ineffective.
- i** An error on the DALI cable (e.g. short-circuit or interrupted cable) is not recognised during the scene-orientated DALI test.
- i** In the scene-orientated DALI test, all the actions are implemented internally using the appropriate KNX objects of the groups and individual devices. Thus, the internal object values can be read out when the brightness values are read out, for example. On scene recall, feedback to the KNX is also transmitted. If no operating device was assigned to the programmed groups and single devices during DALI commissioning, then there will be no visible reaction in the DALI system.
- i** If a DALI operating device is assigned to multiple groups and these groups were assigned to a scene, then the brightness values and colour temperature values of the group with the highest group number are recalled or saved for the multiple-assigned devices. In this case, feedback of the switching status, brightness value or colour temperature of a group cannot always be clear.

Testing effects

The DALI test for effects can be carried out as soon as effects have been created and configured in the device configuration and DALI commissioning has been carried out with the group/device assignment of the operating devices. To do this, press the button "Test DALI effects" in the DALI test environment. The effect test environment then opens.(figure 84).

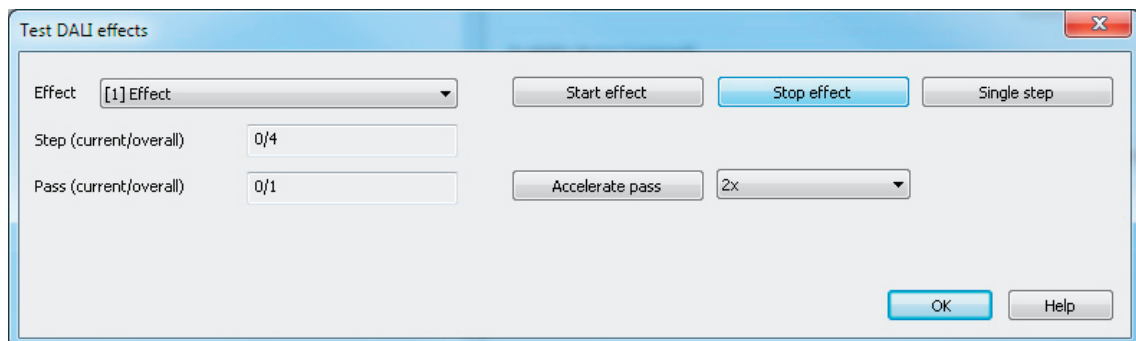

Figure 84: DALI test environment for effects

Even when testing effects, the effect to be tested must first be chosen. To do this, select one of the effects created in the device configuration in the "Effect" selection box. After effect selection, the selected effect can be started or stopped by pressing the appropriate buttons in the test dialog. An effect started using the test dialog runs according to its configuration. The steps are recalled in sequence starting with step 1. The number of effect run-throughs, the dimming behaviour when an effect step is recalled and the delay until the next step are all maintained. The stop step is recalled when an effect is stopped using the DALI test.

The "Single step" button can be pressed to test individual effect steps. Here, the Gateway switches exactly one step forward from the current stop of an effect. We recommend only using the single step function for stopped effects. This allows free switching of entire effect run-throughs.

When the single step function is used, a stopped effect starts with the first step of the effect. The subsequent effect steps are then recalled continuously according to their number. The stop step (last step of an effect) can also be recalled using the single step function.

The test dialog provides status information on the current step and the current run-through of an effect. In addition, the total number of all steps and run-throughs is displayed. In the display box "Step (current/total)", the left-hand number signals the number of the effect step currently set. The right-hand number provides information on the maximum number of steps available in the effect (including the stop step). When an effect step is recalled using the single step function, "..." is displayed on the panel screen. This display goes out if the controller has set all the required brightness values or colour temperature values of the manually recalled effect on the DALI operating devices. The delay until the next effect step specified in the configuration is irrelevant.

In the display box "Run-through (current/total)", the left-hand number shows the number of the current effect run-through. The right-hand number signals the maximum number of all effect run-throughs according to the configuration (the number "0" means that the run-through is set as infinite).

- i It should be noted that the status information in the display boxes during automatic control are only updated cyclically approx. every 3 seconds. With rapid effect run-throughs, it may occur that individual steps or even entire run-throughs are skipped in the display.

The run-through of a running effect can optionally be accelerated in the DALI test. An "Accelerate run-through" button and an input box whose setting specifies the acceleration factor (1x to 10x) are provided for this purpose. With this function it is also possible to test slow effect run-throughs without having to wait for the real-time effect step transitions.

When the button "Accelerate run-through" is pressed, the run-through is accelerated by the specified factor, i.e. the "Delay until next step" programmed into the Gateway for each step. The specification applies to the whole effect, i.e. for all the set delay times of all the effect steps.

- i It should be noted that the acceleration factor only influences the configured delay times which are executed after successfully addressing all the groups, single devices or scenes integrated into the effect step. The time needed by the individual effect controller to execute the addressing operation itself is not influenced by the acceleration. The more single devices that are integrated into an effect step, the longer the addressing operation and the time not influenced by the acceleration will be.
- i Only small acceleration factors should be used for short delay times up to the next effect steps (< 10 s) or longer dimming times, if at all. Otherwise, the effect run-through will be greatly distorted.
- i An error on the DALI cable (e.g. short-circuit or interrupted cable) is not recognised during the effect test.

4.2.4.9 Delivery state

In the Delivery state of the DALI Gateway, the device is passive, i.e. no telegrams are transmitted to the bus. Joint operation of the connected DALI operating devices by broadcast manual operation on the device, if the mains voltage is on. In the manual control mode, no feedback telegrams are sent to the bus. Other functions of the Gateway are deactivated. The device can be programmed and put into operation via the ETS (if the bus and mains voltage supply are connected and switched on). The physical address is preset to 15.15.255

Furthermore, the device has been configured at the factory with the following characteristics...

- Manual operation: broadcast
- Dimming speed, manual operation (0 %...100 %): 3.5 seconds
- Minimum brightness 0.1 %
- Maximum brightness 100 %
- Response to bus voltage failure: No reaction.
- Response to bus voltage return: No reaction.
- Response after return of the mains voltage supply on the DALI Gateway: No reaction from the DALI Gateway. (On the return of mains voltage, the DALI operating devices usually initialise themselves to the most recently programmed "Power-On Level".)

- i The delivery state (broadcast manual operation) can be restored at any time by unloading the application program using the ETS.
- i In the delivery state, no colour temperature control is possible.

4.2.5 Parameters

4.2.5.1 General parameters

Description	Values	Comment
□ General		
Enable DALI device replacement through manual operation ?	no yes	After starting the automatic device replacement, the DALI Gateway is able to check the completeness of the DALI operating devices integrated into the system through a manual operation on the device. The DALI Gateway detects individual replaced electronic ballasts and can program these devices with the appropriate programming data. Only if this parameter is set to "yes" is it possible to initiate automatic device replacement through a manual operation locally on the device (press the buttons  and ALL OFF simultaneously for at least 10 seconds). If set to "no", a manual operation for device replacement will produce no reaction.
Blinking rate	1 sec 2 sec 5 sec 10 sec	Groups or single devices can also be configured as "flashing" at the beginning or at the end of a disabling function, if used. In this case, the appropriate operating devices change their switching state cyclically. The parameter "Flashing rate" generally defines the switch-on time and switch-off time of a flashing message for all groups and devices. Example: Flashing rate = 1 s 1 sec. on -> 1 sec. off -> 1 sec. on -> 1 sec off ...
Central function ?	no yes	The "yes" setting enables the central function and thus the "Central function" object. An assignment of DALI groups or single devices to the central function is only possible if the function is enabled.
Central object polarity	0 = deactivated / 1 = activated 1 = deactivated / 0 = activated	This parameter defines the polarity of the central object. This parameter is visible only if the central function is enabled.
Use setting "DALI device type" ?	no yes	Optionally, the assignment of DALI operating devices to programmed groups or single devices can be supplemented by testing of the DALI

		<p>device types. If testing is enabled, the plug-in compares, during assignment as part of commissioning, the device types determined by the operating devices with the specifications by the device type parameters. Assignment can only take place if there is agreement. This will prevent functional incompatibilities after commissioning.</p> <p>The function for testing the DALI device types is enabled by this parameter when it is set to "yes".</p>
Integrate emergency lights ?	no yes	<p>The DALI Gateway can be integrated into DALI emergency lighting systems. It allows interference-free operation of operating devices, general lighting systems and emergency lighting operating devices of the same DALI system. The "Emergency lighting" function is enabled if this parameter is set to "yes". In this case, the parameter node "Emergency lights", which contains all the relevant parameters for configuring the emergency lighting function, becomes visible.</p>
Integration of tunable white luminaires (TW / DALI device type 8)?	no yes	<p>The DALI Gateway supports the control of DALI operating devices of the device type "Colour Control" (DALI Device Type 8) in the specific version "Tunable White (TW)". This makes it possible to control the colour temperature of a lamp by means of suitable DALI operating devices and luminaires.</p> <p>The use of the colour temperature control can be centrally enabled here.</p>
Use device type for TW luminaires?	yes	<p>If the colour temperature control is used, the ETS plug-in of the Gateway checks the DALI device type indicated by the installed operating device (electronic ballast found) as part of the device assignment during DALI commissioning. Testing of the DALI device type is then essential and subsequently cannot be switched off in the ETS plug-in. For this reason, this parameter cannot be edited. The parameter is only then visible if TW luminaires are integrated and the parameter "Use 'DALI device type' setting ?" is configured to "no".</p>

General -> DALI communication

<p>Activate DALI telegram rate limit ?</p>	<p>no yes</p>	<p>The DALI telegram rate limit can optionally be activated ("yes" setting). Firstly, it is then possible to extend the period of time between DALI telegrams. Secondly, the initialisation behaviour of the Gateway can be influenced. By using the DALI telegram rate limit, it is possible to adapt the communication behaviour of the Gateway to problematic or non-DALI-conformant operating devices to a great extent.</p>
<p>Minimum time delay between two DALI telegrams (1...5 x 9.15 ms)</p>	<p>1.0 1.5 2.0 2.5 3.0 3.5 4.0 4.5 5.0</p>	<p>In accordance with the valid DALI standard, pauses of at least 9.15 ms must be maintained between the transmissions of individual DALI telegrams to the operating devices. Optionally, to reduce the telegram load for the DALI operating devices, and thus reduce the likelihood of errors on the part of some electronic ballasts, it is possible to increase the pause time between telegrams of the DALI Gateway to the operation device by a multiple of the minimum pause time. This produces a telegram rate limit, which can adjusted individually using this parameter in the range 1...5 in steps of 0.5. Extending the pause time between the telegrams gives the operating devices more time to react to the commands of the DALI Gateway. However, this also delays the reaction time of the overall DALI system when controlled by KNX telegrams and also during DALI commissioning or a DALI test. As a result, large time factors should be avoided in the delay time parameter, unless explicitly required. This parameter is only visible if the DALI telegram rate limit is enabled.</p>
<p>Delay time after mains voltage return to DALI (0...30 s)</p>	<p>00...10...30 [ss]</p>	<p>After the mains voltage supply is switched on, depending on the their type, DALI operating devices usually require different lengths of time to initialise themselves and thus to react to commands of the DALI Gateway. To ensure that, after mains voltage return, no commands of the Gateway to the operating devices are lost, because they are still initialising, it is possible to activate a delay as an option here. The delay time after mains voltage return delays the start of the application of the DALI Gateway after the mains voltage supply is switched on, but also after an ETS programming operation, and thus the execution of the configured</p>

		enabled.
Telegram repetition on new error in DALI system ?	no yes	<p>Optionally, the general error status can be transmitted repeatedly, if, after a previously identified DALI error, further errors are detected on the same or other operating devices. The parameter "Telegram repetition on new error in DALI system ?" specifies the behaviour of the general error status feedback for new errors.</p> <p>In the "yes" setting, the general error status is transmitted as "1 - ON" for each new error. In the "no" setting, the general error status is transmitted repeatedly for new errors. Telegrams are only transmitted again via the object "Error status in the DALI system", when no more errors are present.</p> <p>This parameter is only visible if "Error status in DALI system" feedback is enabled.</p>
Feedback "Error status per DALI operating device"?	no yes, feedback object is active signalling object yes, feedback object is passive status object	<p>The DALI Gateway allows the feedback of the individual error status of DALI operating devices in up to two different data formats. To use this feedback function, this parameter must be configured to the "Yes..." setting. assigned automatically. Here, it is possible to define whether the feedback is an active transmitter or is passive (error status must be polled).</p>
Data format of the feedback	only 2-byte KNX object only 1-byte object 1 Byte object and 2 byte KNX object	<p>This parameter determines whether only a 1-byte object (according to KNX DPT 238.600), a 2-byte object (according to KNX DPT 237.600) or a combination of both objects is used.</p> <p>This parameter is only visible if the feedback function is enabled.</p>
Time delay for feedback telegram after initialisation ?	no yes	<p>Optionally, this parameter can be used to activate a delay of the 2-byte feedback after Gateway initialisation (ETS programming operation, mains voltage return). The delay time is globally configured in the parameter node "General -> Status and feedback". After initialisation, the 1-byte error status is generally transmitted immediately. This parameter is only visible in case of an enabled feedback function and actively transmitting feedback.</p>

<p>Feedback DALI-Gateway supply voltage failure / return ?</p>	<p>no yes (only on voltage failure) yes (on voltage failure a return)</p>	<p>The DALI Gateway can monitor its supply voltage (mains voltage connection) and, if there is a failure, transmit a message telegram to the bus before shutting down operation. The "yes" setting activates the message function and disconnects the appropriate object. In addition, there is the specification of whether the message is only to be transmitted when the supply voltage fails or if it should additionally be transmitted when the supply voltage returns.</p>
<p>Feedback DALI short-circuit ?</p>	<p>no yes</p>	<p>The DALI Gateway can transmit a message telegram to the bus when it detects a short-circuit on the DALI cable. The "yes" setting activates the message function and disconnects the appropriate object. Alternatively, the "no" setting deactivates the short-circuit message. When enabled, telegram transmission is always actively transmitting. As soon as a short-circuit has been detected and eliminated, the Gateway will transmit one feedback telegram without a delay.</p>
<p>☐- General -> Status and feedbacks</p>		
<p>Time for cyclical transmission of the feedbacks for groups and devices</p>	<p>00:00:10...00:00:20... 23:59:59 [hh:mm:ss]</p>	<p>Here, the cycle time for cyclical transmission of the feedback functions is defined globally for all DALI groups and single devices.</p>
<p>Time delay for feedbacks after bus volt return for groups and devices</p>	<p>00:00...00:05...59:59 [mm:ss]</p>	<p>This parameter provides a global definition for all DALI groups and single devices of the delay time for automatic transmission of the feedback functions after a device reset. A setting of "0" deactivates the time delay altogether. In this case, all feedback telegrams, if actively transmitted, will be transmitted to the bus without any delay.</p>
<p>Collective feedback switching status ?</p>	<p>no yes</p>	<p>After central commands or after bus/mains voltage return, a KNX line is generally heavily loaded by data traffic as many bus devices are transmitting the state of their communication objects by means of feedback telegrams. This effect occurs particularly when using visualisations. Collective feedback of the Gateway can be used to keep the telegram load low during initialisation. The collective feedback summarises the</p>

		<p>switching states of the DALI groups and single devices in bit-orientated form. Up to 6 separate 4-byte communication objects are available for this, depending on the set addressing type. Each of these objects can visualise the switching state of up to 16 groups or devices. In the "yes" setting, this parameter enables collective feedback.</p>
<p>Collective feedback type</p>	<p>active signalling object passive status object</p>	<p>Collective feedback can take place in the form of active message objects or passive status objects. In the case of active message objects, the feedback is transmitted to the bus whenever the status contained therein changes. In the function as a passive status object, there is no automatic telegram transmission. In this case, the object values must be read out. The ETS automatically sets the communication flags of the objects required for proper functioning. This parameter is only visible if collective feedback is enabled.</p>
<p>Time delay for feedback telegram after bus voltage return ?</p>	<p>no yes</p>	<p>If used as an active message object, the states of the collective feedback are transmitted to the bus after bus or mains voltage return or after programming with the ETS. In these cases, the feedback telegram can be time-delayed with the delay being preset globally for all groups and single devices together. This parameter is only visible in case of an actively transmitting feedback object.</p>
<p>Cyclical transmission of the feedback ?</p>	<p>no yes</p>	<p>The objects of the collective feedback can also transmit their value cyclically in addition to transmission when updating. On "yes", cyclical transmission is performed. The cycle time is configured in the same parameter node. In the "no" setting, cyclical transmission is deactivated which means that collective feedback is only transmitted to the bus if one of the switching states changes. This parameter is only visible in case of an actively transmitting feedback object.</p>
<p>Updating of the object value for collective feedback</p>		<p>Here, you can specify when the Gateway should update the feedback values for the collective feedback in case of an actively transmitting communication object. The object value updated by the Gateway is then</p>

<p>after each update of the inputs</p>	<p>signalled actively to the bus. This parameter is only visible in case of an actively transmitting feedback object.</p>	<p>The Gateway updates the feedback values in the collective feedback once a new telegram is received on the input objects "Switching" or "Central switching" for groups or single devices. With actively transmitting feedback objects, a new telegram is also then actively transmitted to the bus each time. The telegram value of the feedback does not necessarily have to change in the process. Hence, corresponding collective feedbacks are also generated, e.g. for cyclical telegrams to the "Switching" objects.</p>
<p>only if the feedback value changes</p>	<p>The Gateway only updates the feedback values in the collective feedback objects when the telegram values of the inputs also change. If telegram values of the feedback do not change (e.g. in the case of cyclical telegrams to the "Switching" objects with the same telegram value), the feedback then remains unchanged. Consequently, in the case of actively transmitting feedback objects, no telegram with the same content will be transmitted repeatedly either.</p>	
<p>☐ General -> Standby switch-off of DALI devices</p>		
<p>"Standby switch off DALI / Use "Global switching status" feedback ?</p>	<p>no yes</p>	<p>The DALI Gateway offers a function for global feedback of the switching status of all planned DALI groups and devices. This feedback can also be used for standby switch-off of the DALI system, and thus to save energy. In the "yes" setting, this parameter enables feedback of the global switching status.</p>
<p>Type of feedback</p>	<p>active signalling object passive status object</p>	<p>When the standby switch-off is used (active time delays), the feedback of the global switching status will always take place as an active message telegram whenever the feedback value changes. If no time delay has been configured (global switching status for general visualisation purposes), the feedback object - according to this parameter - can either be used as an active signalling object or, alternatively, as a passive status object. As an active message object, the feedback information is also directly transmitted to the bus whenever there is an update. As</p>

		<p>a passive status object, there is no telegram transmission after an update. In this case, the object value must be read out. The ETS automatically sets the object communication flags required for proper functioning. This parameter is only visible if feedback of the global switching status is enabled.</p>
Time delay for feedback telegram after bus voltage return ?	<p>no</p> <p>yes</p>	<p>If used as an active message object, the feedback status is transmitted to the bus after bus/mains voltage return or after programming with the ETS, if switch-on or switch-off takes place after a device reset. If feedback is not used for standby switch-off, the telegram can be transmitted after a delay after bus/mains voltage return, whereby the delay time is set jointly and globally for all the feedback of the device. If a time delay is required, this parameter must be set to "yes". Otherwise ("no" setting), transmission of the active message telegram takes place immediately after a device reset and thus generally when the standby switch-off is used. This parameter is only visible if feedback of the global switching status is enabled and only when there is an active signalling object.</p>
Cyclical transmission of the feedback ?	<p>no</p> <p>yes</p>	<p>Feedback in its function as an active signalling object can also be transmitted cyclically as an option in addition to transmission when the object value changes, although this is only possible if the delay times, and thus the standby switch-off, are not used. The parameter "Cyclical transmission of feedback telegram ?" then specifies if cyclical transmission is enabled or not. If enabled, the parameter "Time for cyclical transmission" on the same parameter page will define the cycle time. This parameter is only visible if feedback of the global switching status is enabled and only when there is an active signalling object.</p>
Updating of the object value	<p>only if the feedback value changes</p>	<p>The update of the feedback of the global switching status will always take place whenever the feedback value changes. This means that the update behaviour cannot be configured here. This parameter is only visible if feedback of the global switching status is enabled and only when there is an active</p>

4.2.5.2 Parameters for manual operation

Description	Values	Comment
☐ Manual operation		
Manual control in case of bus voltage failure	disabled enabled	This parameter can be used for programming whether manual control is to be possible or deactivated in case of bus voltage failure.
Manual control during bus operation	disabled enabled	This parameter can be used for programming whether manual control is to be possible or deactivated during bus operation (bus voltage on).
Disabling function manual operation ?	no yes	Manual control can be disabled via the bus, even if it is already active. For this purpose, the disabling object can be enabled here.
Polarity of disabling object, manual operation	0 = enabled / 1 = disabled 1 = enabled / 0 = disabled	This parameter sets the polarity of the disabling object. In the setting "1 = disabled / 0 = enabled", the disabling function is immediately active on return of bus/mains voltage or after an ETS programming operation (object value = "0"). The parameter is only visible if the disabling function for manual operation is enabled.
Send status manual control ?	no yes	The current state of manual control can be transmitted to the bus via a separate status object, if bus voltage is available (setting: "yes").
Status object function and polarity	0 = inactive; 1 = manual control active 0 = inactive; 1 = permanent manual control active	This parameter defines the information contained in the status object. The object is always "0", when the manual control mode is deactivated. The parameter is visible only if the manual control status transmission is enabled. The object is "1" when the manual control mode is active (temporary or permanent). The object is only "1" when the permanent manual control is active.
Behaviour at the end of permanent manual		The behaviour of the Gateway at the end of permanent manual control depends on this parameter.

control during bus operation

no change

All telegrams received during an active permanent manual control mode for direct operation (switching, dimming, brightness value, central, scenes) will be rejected. After the end of the permanent manual control mode, the current brightness state of all the groups and single devices remains unchanged. If, however, a forced position or disabling function was activated via the bus before or during manual operation of emergency operation, the Gateway executes these functions of a higher priority again for the groups concerned.

Output tracking

During active permanent manual control all incoming telegrams are tracked internally. At the end of manual operation, the groups and single devices are set to the last tracked brightness states. If a forced position or disabling function was activated via the bus before or during manual operation of emergency operation, the Gateway executes these functions of a higher priority again for the groups and single devices concerned.

Bus control of individual groups or single devices can be disabled

no
yes

Individual DALI groups and single devices can be disabled locally so that the disabled DALI operating devices can no longer be controlled via the KNX. Such disabling of the bus operation is initiated by local operation in permanent manual operation and is indicated by flashing of the group or single device number in the 7-segment display. The disabled groups and single devices can then only be activated in permanent manual operation. Disabling via manual operation is only permitted if this parameter is set to "Yes".

4.2.5.3 Parameters for groups and single devices

Description	Values	Comment
<p>□- Addressing Addressing</p>		<p>A DALI system can address a maximum of 64 operating devices, although the Gateway itself does not count as an operating device. Up to 6 different addressing types allow group-orientated and individually-address control of DALI lights via KNX telegrams. Depending on the configuration, up to 32 independent DALI groups are available for group addressing. For alternative control, these can be supplemented with 64 individually-addressable DALI device channels, as necessary.</p>
	Central control.	<p>With master control, all the connected DALI components are controlled by a broadcast command. This means that there is no need to commission DALI, meaning that lighting systems with few functions can be started up quickly and easily (simplified configuration without DALI commissioning). With central addressing, some functions are not available (no emergency lights can be contacted, no error status read out, no collective feedback).</p>
	Group control 1...16	<p>During DALI commissioning or offline configuration, the max. 64 DALI operating devices are assigned to any different groups of the Gateway. For this any number of DALI operating devices can be assigned to each group (1...16). On the DALI side, addressing takes place using group addresses, which the Gateway configures invisibly for the user and manages on its own. During DALI commissioning, the operating devices concerned are automatically programmed accordingly. Through the use of group addresses (multicast), the reaction time of the DALI subscribers in this type of addressing is short - particularly in large-scale systems.</p>
	Group control 1...32	<p>In this addressing type too, during DALI commissioning or offline configuration, the max. 64 DALI operating devices are assigned to different groups of the Gateway. For this, any number of DALI operating devices can be assigned to groups 1...16. On the DALI side, addressing takes place using group addresses, meaning that the reaction time of the DALI subscribers in groups 1...16 is short. In contrast, only up to two DALI operating devices can be assigned to groups 17...32. Since there are no</p>

		DALI group addresses for these groups, DALI addressing takes place using the device short addresses, which means that the operating devices are addressed, and thus contacted, individually. In particular, in large systems with multiple subscribers addressed by short address, the reaction time is slower than with group addressing, as addressing takes place individually and in sequence.
Group control 1...16 and group control 1...64		In this addressing type, the operating devices in groups 1...16 are controlled using DALI group addresses, as described above for group control. In addition, other DALI operating devices can be addressed individually as single devices. The addressing of these devices takes place individually using the device short addresses.
Group control 1...32 and group control 1...64		This addressing type behaves in exactly the same way as the "Group control 1...16 and device control 1...64" addressing, with the difference that groups 17...32 are also available. Here too, groups 17...32 can only be assigned to up to two DALI operating devices. In this case too, as there are no DALI group addresses, DALI addressing takes place using the device short addresses, meaning that the operating devices are addressed, and thus contacted, individually.
Device control 1...64		This addressing type only allows control of up to 64 single devices. DALI group addressing is not possible. As with the other addressing types with device control, the addressing of the devices takes place individually using the device short addresses. It is advisable to use this addressing type if all operating devices are to be controlled individually, for example, and group control is therefore not appropriate.

Addressing -> Groups... -> [x] Group

Addressing -> Single devices... -> [x] Electronic ballast

Name	0...28 characters Group / Electronic ballast	Here, the group or the single device can be assigned a unique name (e.g. "Office, window side 1"). The name is used for better orientation in the plug-in. It is not programmed into the device.
Short address	1...64	The device short addresses are assigned here in the parameter configuration of the single devices and can thus be influenced. Short addresses must be unique. This means that

		addresses may not appear multiple times in a DALI system. The ETS plug-in of the DALI Gateway checks the editing of short addresses and checks that they are unique.
		This parameter is only available for planned single devices. The presetting is dependent on the selected electronic ballast.
Device type	<p>Ballast for fluorescent lamps</p> <p>Ballast for discharge lamps</p> <p>Ballast for LV halogen lamps</p> <p>Ballast for Incandescent lamps</p> <p>LED module</p> <p>only switchable ballast</p> <p>Control gear for colour control (Tunable White)</p> <p>Multitype</p>	<p>Optionally, the assignment of DALI operating devices to programmed groups or single devices can be supplemented by testing of the DALI device types. If testing is enabled ("Use setting 'DALI device type' ?" parameter under "General"), the plug-in compares, during assignment as part of commissioning, the device types determined by the operating devices with the specifications by the device type parameters. Assignment can only take place if there is agreement. This will prevent functional incompatibilities after commissioning.</p> <p>For integration of tunable white lights: If colour temperature controllable lights operated with single batteries are used, the ETS plug-in of the Gateway checks the DALI device type indicated by the installed operating device (electronic ballast found) as part of the device assignment during DALI commissioning. Testing of the DALI device type is then essential and therefore cannot be switched off in the ETS plug-in for integration of tunable white luminaires. This avoids incorrect assignments. The device type of the operating device is set here. In the settings "Control gear for colour control (Tunable White)" and "Multitype" the parameter nodes for the TW function are visible if the use of tunable white lights is provided for under "General".</p> <p>This parameter is only available for planned single devices.</p>
Minimum brightness	<p>0.1 %</p> <p>0.2 %</p> <p>0.5 %</p> <p>1 %</p> <p>3 %</p> <p>5 %</p> <p>10 %</p> <p>15 %</p> <p>20 %</p>	<p>The minimum brightness is set here. The configured value is not undershot in any state of operation of the Gateway.</p> <p>i The upper limit of the selection of the value settable here is limited by the configured maximum brightness (minimum brightness < maximum brightness).</p>

	25 %		
	30 %		
	35 %		
	40 %		
	45 %		
	50 %		
	55 %		
	60 %		
	65 %		
	70 %		
			<p>i During editing of the minimum brightness, the ETS plug-in checks all the configured brightness values of the group or the single device (e.g. switch-on brightness, scene values) to determine whether the values undershoot the minimum brightness. If this is the case, the plug-in will signal a value conflict and offer adjustments.</p>
Maximum brightness	30 %		
	35 %		
	40 %		
	45 %		
	50 %		
	55 %		
	60 %		
	65 %		
	70 %		
	75 %		
	80 %		
	85 %		
	90 %		
	95 %		
	100 %		
			<p>The maximum brightness is set here. The configured value is not exceeded in any state of operation of the Gateway.</p> <p>i The lower limit of the selection of the value settable here is limited by the configured minimum brightness (minimum brightness < maximum brightness).</p> <p>i During editing of the maximum brightness, the ETS plug-in checks all the configured brightness values of the group or the single device (e.g. switch-on brightness, scene values), to see if the values exceed the maximum brightness. If this is the case, the plug-in will signal a value conflict and offer adjustments.</p>
Switch-on brightness			<p>This parameter specifies the brightness value, to which the group or the single device is set to whenever switching on via the "Switching" or "Central function switching" object.</p>
	Brightness value		<p>On switching on, the predefined brightness value in the selection box next to the parameter is set to. The selection of the settable value is limited by the configured minimum and maximum brightness.</p>
	Memory value (brightn. bef. switch. off last time)		<p>On switch-on, the active and internally-saved brightness value prior to switching off last time is set (via the "Switching" or "Central function switching" object). This memory value is saved in the volatile memory, which means that after a bus/mains voltage return or an ETS programming operation, the value is predefined to maximum brightness.</p>
Behaviour after ETS programming			<p>The Gateway permits setting of the defined brightness value after ETS programming.</p>
	switch off		

		The group or the single device is switched off.
	Brightness value	The group or the single device is set to the predefined brightness value in the selection box next to the parameter. The selection of the settable value is limited by the configured minimum and maximum brightness.
	no change	After an ETS programming operation, the DALI operating devices of the group or the single device show no response and remain in the currently set brightness state.
Behaviour in case of bus voltage failure		The Gateway permits setting the brightness value separately for each dimming channel in case of bus voltage failure.
	switch off	The group or the single device is switched off.
	Brightness value	The group or the single device is set to the predefined brightness value in the selection box next to the parameter. The selection of the settable value is limited by the configured minimum and maximum brightness.
	no change	If there is a bus voltage failure, the DALI operating devices of the group or the single device show no response and remain in the currently set brightness state.
Behaviour after bus voltage return		The Gateway permits setting of the brightness value after bus or mains voltage return separately for each DALI group.
	switch off	The group or the single device is switched off.
	Brightness value	The group or the single device is set to the predefined brightness value in the selection box next to the parameter. The selection of the settable value is limited by the configured minimum and maximum brightness.
	Brightness value before bus voltage failure	After bus or mains voltage return, the brightness value set most recently before the bus or mains voltage failure and saved internally on bus/mains voltage failure will be tracked.
	no change	After bus/mains voltage return, the DALI operating devices of the group or the

		single device show no response and remain in the currently set brightness value or are switched off.
	Start staircase function	The staircase function is – irrespective of the 'Switching' object - activated after bus/mains voltage return. This setting is only available when the staircase function is enabled.
Supplementary function type	No supplementary function	The supplementary function can be defined and enabled here. The disabling function is only configurable as an alternative to the forced position function.
	Disabling function	
	Forced position function	
Polarity of the disabling object	0 = enabled / 1 = disabled 1 = enabled / 0 = disabled	This parameter defines the polarity of the disabling object. It is visible only if the disabling function is enabled.
Behaviour at the beginning of the disabling function	switch off	The behaviour of the DALI group or single device at the start of disabling can be configured. This parameter is visible only if the disabling function is enabled. At the start of disabling, the group or the single device is switched off and locked.
	Brightness value	At the start of disabling, the group or the single device is set to the predefined brightness value in the selection box next to the parameter. The selection of the settable value is limited by the configured minimum and maximum brightness.
	no change	At the start of disabling, the DALI operating devices of the group or the single device show no response and remain in the currently set brightness state or are switched off. Bus operation is then locked.
	Memory value (brightn. bef. switch. off last time)	At the start of the disabling function, the active and internally-saved brightness value prior to switching off last time is set (via the "Switching" object). This memory value is saved in the volatile memory, which means that after a bus/mains voltage return or an ETS programming operation, the value is predefined to maximum brightness. Bus operation is then locked.
	flashing	The DALI operating devices of the group or the single device flash on and off during disabling. Bus operation is locked during this time. The flashing time is generally configured in the parameter

Behaviour at the end of the disabling function	node "General". During the flashing, the logical switching state is "on 1" and the switch-on brightness is signalled back as brightness. A soft ON/OFF function is ignored during flashing.
switch off	<p>The behaviour of the DALI group or single device at the end of disabling can be configured. This parameter is visible only if the disabling function is enabled.</p> <p>At the end of the disabling function, the group or the single device is switched off and enabled again.</p>
Brightness value	<p>At the end of disabling, the group or the single device is set to the predefined brightness value in the selection box next to the parameter. The selection of the settable value is limited by the configured minimum and maximum brightness.</p>
no change	<p>At the end of disabling, the DALI operating devices of the group or the single device show no response and remain in the currently set brightness state or are switched off. Bus operation is enabled again.</p>
Memory value (brightn. bef. switch. off last time)	<p>At the end of disabling, the active and internally-saved brightness value prior to switching off last time is set (via the "Switching" or "Central function switching" object). This memory value is saved in the volatile memory, meaning that after a bus voltage return or an ETS programming operation, the value is predefined to maximum brightness. Bus operation is enabled again.</p>
flashing	<p>The DALI operating devices of the group or the single device are always enabled again for the bus control at the end of the disabling and flash on and off. The flashing time is generally configured in the parameter node "General". During the flashing, the logical switching state is "on 1" and the switch-on brightness is signalled back as brightness. A soft ON/OFF function is ignored during flashing. The flashing status remains active until another bus command is received and or manual operation specifies another status.</p>
tracked brightness value	<p>At the end of the disabling, the state received during the disabling function or adjusted before the disabling function can be tracked with the appropriate brightness value. Any elapsed time functions will also be taken into account if necessary.</p>

Behaviour after bus voltage return

The forced position communication object can be initialised after bus voltage return. The brightness status of the DALI group or the single device can be influenced when the forced position function is activated. This parameter is only visible when the forced position function is enabled.

no forced position active

No forced position is activated after bus voltage return.

Forced position active, switch on

The forced position is activated. The DALI operating devices of the group or the single device are switched on to the brightness value predefined by the parameter "Switch on brightness for forced position ON".

Forced position active, switch off

The forced position is activated. The DALI operating devices of the group or the single device are forced to switch off.

State before bus voltage failure

The state of the forced position is set in such a way as it was stored non-volatile at the time of the bus failure. After programming the application or parameters with the ETS, the value is set internally to "not active". If the function is activated, the DALI operating devices of the group or the single device are switched on to the brightness value predefined by the parameter "switch on brightness for forced position ON".

Brightness for forced position active, ON

If the forced position is activated and forced-position state is "ON", you can define here how the DALI operating devices of the group should behave. This parameter is only visible when the forced position function is enabled.

Brightness value

The group or the single device is set to the predefined brightness value in the selection box next to the parameter. The selection of the settable value is limited by the configured minimum and maximum brightness.

no change

The DALI operating devices of the group or the single device show no response and remain in the currently set brightness state.

Memory value (brightn. bef. switch. off last time)

The active and internally-saved brightness value prior to switching off last time is set (via the "Switching" or "Central function switching" object). This memory value is saved in the volatile memory, which means that after a

		bus/mains voltage return or an ETS programming operation, the value is predefined to maximum brightness.
Behaviour at the end of the forced position function		The behaviour of the DALI group or single device at the end of the forced position can be configured here. This parameter is only visible when the forced position function is enabled.
	no change	At the end of the forced position, the DALI operating devices of the group or the single device show no response and remain in the currently set brightness state or are switched off. Bus operation is enabled again.
	tracked brightness value	At the end of a forced position, the state received during the forced position function or adjusted before the function can be tracked with the appropriate brightness value. Any time functions still in progress will also be taken into account if necessary. Bus operation is enabled again.
<p><input type="checkbox"/> Addressing -> Groups... -> [x] Group -> Switching</p> <p><input type="checkbox"/> Addressing -> Single devices... -> [x] Electronic ballast -> Switching</p>		
Feedback switching status ?		The current switching state of the DALI group or the single device can be reported back separately to the bus.
	no	No feedback object available for the group or the single device. feedback deactivated
	yes, feedback object is active signalling object	Feedback and the object are activated. The state is not transmitted inverted. The object transmits actively (telegram transmission after change / update or possibly cyclically).
	yes, feedback object is passive status object	Feedback and the object are activated. The state is not transmitted inverted. The object is passive (telegram transmission only as a response to 'Read' request).
Time delay for feedback telegram after bus voltage return ?	no	The feedback telegram can be transmitted to the bus with a delay after bus voltage return or after programming with the ETS. Setting "yes" activates the delay time of the feedback in case of bus voltage return. The delay time is generally configured in the parameter node "General -> Status and feedback". This parameter is only visible in case of an actively transmitting feedback object.
	yes	

<p>Cyclical transmission of the feedback ?</p>	<p>no yes</p>	<p>The switching status feedback telegram can also be transmitted cyclically via the active message object in addition to the transmission after updating. On "yes", cyclical transmission is performed. The cycle time is generally configured in the parameter node "General -> Status and feedback". On "no", cyclical transmission is deactivated so that the feedback telegram is only transmitted when the switching status is changed or updated. This parameter is only visible in case of an actively transmitting feedback object.</p>
<p>Updating the object value for switching status feedback</p>	<p>after each update of the inputs</p>	<p>Here, you can specify when the Gateway should update the feedback value for the switching status in case of an actively transmitting communication object. The object value updated by the Gateway is then signalled actively to the bus. This parameter is only visible in case of an actively transmitting feedback object.</p>
<p>only if the feedback value changes</p>	<p></p>	<p>The Gateway updates the feedback value in the object once a new telegram is received on the input objects "Switching" or "Central switching". With an actively transmitting feedback object, a new telegram is also then actively transmitted to the bus each time. The telegram value of the feedback does not necessarily have to change in the process. Hence, a corresponding switching status feedback is also generated on the "Switching" object such as in the case of cyclical telegrams for example. In addition, feedback is transmitted at the beginning or end of a disabling or forced position function, and also during an effect run-through, even if the feedback state does not change.</p> <p>The Gateway only updates the feedback value in the object if the telegram value (e.g. "OFF" to "ON") also changes. If the telegram value of the feedback does not change (e.g. in the case of cyclical telegrams to the "Switching" object with the same telegram value), the feedback then remains unchanged. Consequently, with an actively transmitting feedback object, no telegram with the same content will be transmitted repeatedly either. This setting is recommendable, for instance, if the "Switching" and "Switching feedback" objects are linked to an identical group address. This is</p>

		often the case when activating by means of light scene push-button sensors (recall and storage function).
Assignment to central function ?	no yes	This parameter determines the assignment of the DALI group or the single device to the central function. This parameter is visible only if the central function is enabled.
<input type="checkbox"/> Addressing -> Groups... -> [x] Group -> Dimming		
<input type="checkbox"/> Addressing -> Single devices... -> [x] Electronic ballast -> Dimming		
Time for relative dimming (0-100%)	00:00:01... 00:00:05 ... 05:59:59 [hh:mm:ss]	This parameter sets the relative dimming step time (4-bit dimming). The time entered here defines the maximum length for dimming over the entire brightness range of 0 % to 100 % brightness.
Dimming behaviour on receipt of a brightness value	dimming to jumping to	A parameter is used here to define whether a brightness value received via the bus is instantly jumped to (absolute dimming), or whether the brightness is dimmed to.
Time for absolute dimming (0-100%)	00:00:01... 00:00:05 ... 23:59:59 [hh:mm:ss]	This parameter sets the absolute dimming step time (1-bit dimming). The time entered here defines the maximum length for dimming over the entire brightness range of 0 % to 100 % brightness. This parameter is only visible in the setting "Dimming behaviour on receipt of a brightness value" = "dimming to".
Automatic switch-off if a brightness is undershot ?	no yes	The switch-off function permits automatic switching of a DALI group or a single device after a brightness value was dimmed or jumped to and this new brightness value is below a switch-off brightness set in the ETS. The automatic switch-off function can be activated here.
Switch-off if brightness value smaller	0.1 %... 5 % ...100 %	This parameter defines the brightness or speed, which if reached or undershot, will cause the group or the single device to be switched off at the end of a dimming procedure, or if necessary, after a delay time has elapsed. The selection of the settable value is limited by the configured minimum and

		<p>maximum brightness. The standard setting adapts itself accordingly. If the switch-off brightness was undershot because of a disabling or forced position function or a pre-warning of the staircase function, the switch-off function is not executed!</p> <p>This parameter is only visible if the switch-off function is activated.</p>
Delay until switch-off ?	<p>no</p> <p>yes</p>	<p>The time delay of the switch-off function can be activated here. If the switch-off brightness is reached or undershot at the end of a dimming procedure, the DALI group or the single device is switched off after the delay time has elapsed.</p> <p>This parameter is only visible if the switch-off function is activated.</p>
Delay time until switching off	<p>00:01...00:30... 59:59 [mm:ss]</p>	<p>This parameter sets the delay time of the switch-off function. If the switch-off brightness is reached or undershot at the end of a dimming procedure, the DALI group or the single device is switched off after the time set here has elapsed.</p> <p>This parameter is visible only if the switch-off function is activated and visible when the delay time is enabled.</p>
Feedback brightness value?	<p>no</p> <p>yes, feedback object is active signalling object</p> <p>yes, feedback object is passive status object</p>	<p>The current brightness value of the DALI group or the single device can be reported separately back to the bus.</p> <p>No feedback object available for the group or the single device. feedback deactivated</p> <p>Feedback and the object are activated. The object transmits actively (telegram transmission after change / update or possibly cyclically).</p> <p>Feedback and the object are activated. The object is passive (telegram transmission only as a response to 'Read' request).</p>
Time delay for feedback telegram after bus voltage return ?	<p>no</p> <p>yes</p>	<p>The feedback telegram can be transmitted to the bus with a delay after bus voltage return or after programming with the ETS. Setting "yes" activates the delay time of the feedback in case of bus voltage return. The delay time is generally configured in the parameter node "General -> Status and feedback".</p>

<p>Cyclical transmission of the feedback ?</p> <p>no</p> <p>yes</p>	<p>This parameter is only visible in case of an actively transmitting feedback object.</p>
<p>Updating the object value for brightness value feedback</p>	<p>The brightness value feedback telegram can also be transmitted cyclically via the active message object in addition to the transmission after updating. On "yes", cyclical transmission is performed. The cycle time is generally configured in the parameter node "General -> Status and feedback". On "no", cyclical transmission is deactivated so that the feedback telegram is only transmitted when the brightness value is changed or updated.</p> <p>This parameter is only visible in case of an actively transmitting feedback object.</p>
<p>after each update of the inputs</p>	<p>Here, you can specify when the Gateway should update the feedback value for the brightness value in case of an actively transmitting communication object. The object value updated by the Gateway is then signalled actively to the bus.</p> <p>This parameter is only visible in case of an actively transmitting feedback object.</p>
<p>only if the feedback value changes</p>	<p>The Gateway updates the feedback value in the object once a new telegram is received on the input object "brightness feedback". With an actively transmitting feedback object, a new telegram is also then actively transmitted to the bus each time. The telegram value of the feedback does not necessarily have to change in the process. Hence, a corresponding brightness value feedback is also generated on the "brightness value feedback" object such as in the case of cyclical telegrams for example. In addition, feedback is transmitted at the beginning or end of a disabling or forced position function, and also during an effect run-through, even if the feedback state does not change.</p> <p>The Gateway only updates the feedback value in the object if the telegram value (e.g. "0 %" to "100 %") also changes. If the telegram value of the feedback does not change (e.g. in the case of cyclical telegrams to the "brightness value" object with the same telegram value), the feedback then remains unchanged. Consequently, with an actively transmitting feedback object, no telegram with the same content will be transmitted repeatedly either. This</p>

DALI characteristic curve

setting is recommendable, for instance, if the "brightness value" and "brightness value feedback" objects are linked to an identical group address. This is often the case when activating by means of light scene push-button sensors (recall and storage function).

When dimming, the logarithmic characteristic curve provided for DALI and stored in the operating devices is not ideal for every control task. For this reason, the KNX DALI Gateway offers the possibility of influencing the DALI dimming characteristic without having to intervene in the operating devices.

linear

In this setting, the Gateway linearises the DALI dimming characteristic by converting all brightness values, which are received from the KNX and configured in the ETS, appropriately into DALI data values. Thus, the KNX brightness values form linearly on the luminous flux emitted by the DALI luminaire. The Gateway itself does not dim linearly in this setting. A linear dimming sequence of the relative luminous flux first results at the physical output of an operating device through the combination of the non-linear conversion of the Gateway and the logarithmic characteristic of the operating devices. Feedbacks of the brightness value to the KNX are also adjusted through conversion.

logarithmic

With this setting, the Gateway forwards KNX brightness values to the DALI page virtually unprocessed. Merely a smoothing of the data values in the lower dimming range takes place. A logarithmic dimming sequence of the relative luminous flux results at the physical output of an operating device through the combination of forwarding the value of the Gateway and the logarithmic characteristic of the operating devices. Feedbacks of the effective DALI brightness value to the KNX is also possible in this case.

Addressing -> Groups... -> [x] Group -> Switch-on/switch-off behaviour

Addressing -> Single devices... -> [x] Electronic ballast -> Switch-on/switch-off behaviour

Selection of time delay **none**

The communication objects "Switching" and "Central function switching" can be evaluated after a time delay. By this setting the desired function of the time

Switch-on delay

	Switch-off delay ON delay and OFF delay	delay is selected and the additional parameters of the delay enabled.
Switch-on delay time	00:00:01... 00:00:30 ... 23:59:59 [hh:mm:ss]	This parameter is used for setting the duration of the switch-on delay. This parameter is only visible if switch-on delay or switch-on and switch-off delay are activated.
Switch-on delay retriggerable ?	no yes	A switch-on delay still in progress can be retriggered (setting "yes") by another "1" telegram. Alternatively, the retriggering time can be suppressed (setting "no"). This parameter is only visible if switch-on delay or switch-on and switch-off delay are activated.
Switch-off delay time	00:00:01... 00:00:30 ... 23:59:59 [hh:mm:ss]	This parameter is used for setting the duration of the switch-off delay. This parameter is only visible if switch-on delay or switch-on and switch-off delay are activated.
Switch-off delay retriggerable ?	no yes	A switch-off delay still in progress can be retriggered (setting "yes") by another "0" telegram. Alternatively, the retriggering time can be suppressed (setting "no"). This parameter is only visible if switch-on delay or switch-on and switch-off delay are activated.
Soft ON function ?	no yes	The soft ON function permits slower switch-on. If this function (setting "yes") is activated, a dimming procedure to the switch-on brightness is started after receiving a switch-on telegram via the "Switching" or "Central function switching" object.
Time for soft ON (0...100 %)	00:00:01... 00:00:05 ... 23:59:59 [hh:mm:ss]	This parameter sets the dimming increment time for the Soft ON function. The time entered here defines the maximum length for Soft ON dimming over the entire brightness range of 0 % to 100 % brightness. The Soft ON time cannot be retriggered. This parameter is visible only if the Soft ON function is enabled.

Soft OFF function ?	<p>no</p> <p>yes</p>	<p>The soft OFF function permits slower switch-off. If this function (setting "yes") is activated, a dimming procedure is started at minimum brightness and then switched off after receiving a switch-off telegram via the "Switching" or "Central function switching" object.</p>
Time for Soft OFF (0...100 %)	<p>00:00:01...00:00:05...</p> <p>23:59:59</p> <p>[hh:mm:ss]</p>	<p>This parameter sets the dimming increment time for the Soft OFF function. The time entered here defines the maximum length for Soft OFF dimming over the entire brightness range of 100 % to 0 % brightness. The Soft OFF time cannot be retriggered. This parameter is visible only if the Soft OFF function is enabled.</p>
<p><input type="checkbox"/> Addressing -> Groups... -> [x] Group -> Staircase function</p> <p><input type="checkbox"/> Addressing -> Single devices... -> [x] Electronic ballast -> Staircase function</p>		
Staircase function ?	<p>no</p> <p>yes</p>	<p>The staircase function and, as a result, the appropriate communication objects and parameters can be enabled here.</p>
Staircase time	<p>00:00:01...00:02:00...</p> <p>23:59:59</p> <p>[hh:mm:ss]</p>	<p>This parameter is used for programming the duration of the switch-on time for a scene recall. This parameter is only visible if the staircase function is enabled.</p>
Staircase time retriggerable ?	<p>no</p> <p>yes</p>	<p>An active switch-on time can be retriggered (setting "yes"). Alternatively, the retriggering time can be suppressed (setting "no"). This parameter is only visible if the staircase function is enabled.</p>
Reaction to OFF-telegram	<p>ignore</p> <p>switch off</p>	<p>An active switch-on time can be aborted prematurely by switching off the staircase function. This parameter is only visible if the staircase function is enabled.</p> <p>OFF telegrams received via the object "Staircase function start / stop" during the ON phase of the staircase function are rejected. The staircase time will be executed completely to the end with the configured "behaviour at the end of the staircase time".</p> <p>Once an OFF telegram is received via the object "Staircase function start/stop" during the ON phase of the staircase</p>

		<p>time, the operating devices switch off immediately. If the staircase time is stopped prematurely by such a telegram, there is no pre-warning, i.e. the pre-warning time is not started. It is also not dimmed to a reduced continuous lighting. It is also possible to switch off prematurely during a dimming procedure of a soft function or during a pre-warning or reduced continuous lighting.</p>
<p>Reaction at the end of the staircase time</p>	<p>switch off</p> <p>Activate pre-warning time</p> <p>Activate reduced continuous lighting</p>	<p>At the end of the switch-on time of the staircase function, the DALI group or the single device shows the behaviour configured here. The DALI group or the single device can be set to switch off immediately, alternatively to dim to the reduced continuous lighting (application: e.g. long, dark hallways) or to execute the pre-warning function.</p>
<p>Reduced brightness</p>	<p>0.1 %...10 %...100 %</p>	<p>This parameter defines the reduced brightness that is set for pre-warning or continuous lighting. The selection of the settable value is limited by the configured minimum and maximum brightness. The standard setting adapts itself accordingly.</p> <p>This parameter is only visible if the staircase function is enabled and the pre-warning time or continuous lighting is activated.</p>
<p>Pre-warning time</p>	<p>00:00:01...00:00:30... 23:59:59 [hh:mm:ss]</p>	<p>This parameter is used for setting the duration of the pre-warning time. The pre-warning time is added to the switch-on time. The reduced brightness is set during the time configured here.</p> <p>This parameter is only visible if the staircase function is enabled and the activated pre-warning time is activated.</p>
<p>Supplementary function for staircase function</p>	<p>No supplementary function</p>	<p>The staircase function can be extended by the two supplementary functions "Time extension" and "Time specifications via bus", which should be used alternatively. This parameter enables the desired supplementary function and thereby activates the necessary parameters or objects.</p> <p>This parameter is only visible if the staircase function is enabled.</p> <p>No supplementary function is enabled.</p>

	Time preset via the bus	The time preset via the bus is activated. With this supplementary function, the configured switch-on time can be multiplied by a factor received via the bus, thus it can be adapted dynamically.
	time extension	The time extension is activated. This function permits retriggering an activated staircase lighting time span-times via the object "Staircase function start/stop".
Staircase function can be activated via "Staircase time factor" object ?	<p>no</p> <p>yes</p>	<p>A time preset via the bus can specify here whether the receipt of a new time factor also starts the switch-on time (setting "yes"). At the same time, the object "Staircase function start/stop" is hidden.</p> <p>If the setting is "no", the switch-on time can be activated exclusively via the object "Staircase function start/stop". This parameter is visible only if the supplementary function "Time preset via the bus" is set.</p>
Maximum time extension	<p>1-fold time</p> <p>2-fold time</p> <p>3-fold time</p> <p>4-fold time</p> <p>5-fold time</p>	<p>With the time extension function, the staircase time can be retriggered several times (i.e. extended) via the "Staircase function start/stop" object. The duration of the extension is predefined by several operations at the control section (several ON telegrams in succession). The configured staircase time can be extended in this way within a time period by a maximum of the configured factor here. The time is then always extended automatically at the end of a single staircase time.</p> <p>The retriggering within the period of a staircase time can only occur as often as the configured factor specifies. This parameter is visible only if the supplementary function "time extension" is set.</p> <p>i A time extension can generally be triggered during the entire switch-on time. In each period of an extended staircase time, new extensions can take place by telegrams. The "Maximum time extension" parameter is re-evaluated in each new time period.</p>

Addressing -> Groups... -> [x] Group -> Operating hours counter

Addressing -> Single devices... -> [x] Electronic ballast -> Operating hours counter

<p>Operating hours counter ?</p>	<p>no yes</p>	<p>The operating hours counter can be disabled or enabled here. When the function is enabled, the corresponding parameters will be displayed under "[x] Device name - Operating hours counter" and the necessary object enabled.</p> <p>i If the operating hours counter is disabled, any operating hours that may have been counted previously will be deleted and any limiting or start values predefined for the affected DALI group and the affected single device via the object will be reset.</p>
<p>Type of counter</p>	<p>Up-counter Down-counter</p>	<p>The operating hours counter can be configured as an up-counter or down-counter. The setting here influences the visibility of the other parameters and objects of the operating hours counter.</p>
<p>Start/Limiting value presetting ?</p>	<p>no yes, as received via object yes, as specified in parameter</p>	<p>This parameter defines whether the start or limiting value can be set via a separate parameter or adapted individually by a communication object from the bus.</p> <p>The "No" setting deactivates the limiting value.</p> <p>i If the up-counter is used, a limiting value can optionally be predefined.</p> <p>i If the down-counter is used, a start value can optionally be predefined.</p>
<p>Start/limiting value (0...65535 hrs.)</p>	<p>0...65535</p>	<p>The limiting value of the up-counter or the start value of the down-counter is set here.</p> <p>Once the limiting value is reached, a "1" telegram is transmitted via the object "OHC elapsed". The up-counter itself continues until the maximum counter status (65535) is reached and then stops.</p> <p>After the initialisation, the down-counter starts counting down the predefined value by the hour until the value "0". If this end value is reached, a "1" telegram is transmitted via the object "OHC elapsed".</p> <p>This parameter is only visible if the parameter "Start / limiting value specification ?" is set to "Yes like the parameter".</p>

Automatic transmitting of the counter value

cyclical

The current counter status of the operating hours counter can be transmitted actively to the bus via the "OHC value" communication object.

The meter reading is transmitted cyclically to the bus and when there is a change. The cycle time is parameterised under "Times" generally for all dimming channels.

after change by interval value

The meter reading is transmitted to the bus only when there is a change.

Counting value interval (1...65535 h) 1...**65535**

The interval of the counter value is set here for automatic transmission. The current meter reading is transmitted to the bus after the time value configured here.

This parameter is only visible if the parameter "Automatic transmission of the number value" is set to "Change on interval value".

Addressing -> Groups... -> [x] Group -> Emergency lights, centrally-supplied

Addressing -> Single devices... -> [x] Electronic ballast -> Emergency lights centrally-supplied

Define separate brightness value for emergency operation ? **no**
yes

It is necessary to define the brightness value or the behaviour for emergency operation. Irrespective of whether the scope of emergency operation also includes the Gateway (see parameter "Scope of emergency operation"), the behaviour of all the electronic ballasts of a DALI group or all the single devices in emergency operation can be influenced differently.

If the scope of emergency operation only allows for the integration of the emergency lights - optionally also including the KNX system (Gateway not integrated), due to the switched-off DALI voltage, the operating devices supplied with emergency current set the "System Failure Level" saved in the device at the beginning of emergency operation as the brightness value. This brightness value was written by the DALI Gateway to the DALI operating devices after ETS commissioning. By default, the "System Failure Level" is defined by the "Behaviour in case of bus voltage failure" parameter of a group or single device. Optionally, this value - irrespective of the behaviour in case of bus voltage failure - can be set to a separate brightness value for emergency operation. To do this, set this parameter to "yes". The parameter

<p>Brightness value in emergency light operation</p>	<p>0.1 %...10 %...100 %</p>	<p>"Brightness value in emergency operation" then available defines the value for the "System Failure Level" regardless of the behaviour in case of bus voltage failure. This parameter is only visible if the scope of emergency operation does not allow for the integration of the DALI Gateway.</p>
<p>Integrate into emergency light operation.</p>	<p>no yes</p>	<p>If the scope of emergency operation also allows for the integration of the Gateway, the Gateway requires the information of which of the DALI operating devices are integrated into centrally-supplied emergency operation. Furthermore, it is necessary to define the brightness value or the behaviour for emergency operation. Here, it is possible to define whether the single device is integrated in the centrally-supply emergency operation. This parameter is only visible if the scope of emergency operation also allows for the integration of the DALI Gateway.</p>
<p>Define behaviour at the start of emergency operation ?</p>	<p>no yes</p>	<p>Here, it is possible to define which reaction the single device shows at the beginning of emergency operation. In the "yes" setting, the parameters "Brightness at the beginning of emergency operation" and "Colour temp. at the beg. of emerg. oper.(1000...10000 K)" (the latter, however, only if the integration of tunable white lights is provided for under "General") are visible, which then immediately specify the values to be set for the emergency operation. In the "no" setting, the electronic ballast remains on the brightness and colour temperature value last set in normal operation. This parameter is only visible if the scope of emergency operation also allows for the integration of the DALI Gateway, the single device is integrated</p>

in emergency light operation.

Brightness at the beginning of emergency operation 0.1 %...**10 %**...100 %

The Gateway controls the electronic ballast to the brightness value specified by this parameter. The brightness value specified here is also entered into the DALI operating devices as the System Failure Level. If the mains voltage supply of the DALI Gateway should fail, and consequently the DALI voltage, the operating devices affected will also set themselves to this brightness value. If the parameter is unavailable (parameter "Define behaviour at the start of emergency operation ?" set to "no"), the "System Failure Level" is defined by the "Behaviour in case of bus voltage failure" parameter of a group or single device.

This parameter is only visible if the scope of emergency operation also allows for the integration of the DALI Gateway, the single device is integrated in emergency light operation and behaviour at the start of emergency operation is to be defined.

Colour temperature at the beginning of emergency operation (1000...10000 K) 1000...**5300**...10000

When activating operating devices that support the device type "Colour Control" (DALI Device Type 8), a colour temperature can also be defined for the emergency operation - if the emergency operation also provides for the integration of the Gateway - besides a brightness value in this configuration. This parameter defines the colour temperature value for the emergency operation and is available if the parameter "Define behaviour at the start of emergency operation ?" is configured to "yes". Otherwise ("no" setting), the operating devices assigned to emergency operation remain at the last set colour temperature value.

This parameter is only available if the integration of tunable white lights is provided for and at least one device (individually addressed and group-controlled) is configured to the device type "Control gear for colour control (Tunable White)" or "Multitype".

Addressing -> Groups... -> [x] Group -> Tunable White function

Addressing -> Single devices... -> [x] Electronic ballast -> Tunable white function

1000...**2000**...10000

The minimum colour temperature of a DALI group and single device can be set

Minimum colour temperature
(1000...10000 K)

here. The configured colour temperature is not undershot in any operating state.

i During editing of the minimum colour temperature, the ETS plug-in checks all configured colour temperature values of the group or the single device (e.g. switch-on colour temperature, scene values) to determine whether the values undershoot the minimum colour temperature. If this is the case, the plug-in will signal a value conflict and offer a selection.

Maximum colour temperature
(1000...10000 K)

1000...**6000**...10000

The maximum colour temperature of a DALI group and single device can be set here. The configured colour temperature is not exceeded in any operating state.

i During editing of the maximum colour temperature, the ETS plug-in checks all the configured colour temperature values of the group or the single device (e.g. switch-on colour temperature, scene values) to determine whether the values exceed the maximum colour temperature. If this is the case, the plug-in will signal a value conflict and offer a selection.

Colour temperature after switching on

Here, the colour temperature value, which is set whenever switching on occurs via the "Switching" or the "Central function switching" object on the DALI operating devices, can be predefined. This parameter defines the switch-on colour temperature value separately for each group and each single device. The settable value is anywhere between the minimum and maximum colour temperature.

Memory val. (colour bef. switch. off last time)

On switching on, the active and internally saved colour temperature value prior to switching off last time is set (via the "Switching" or "Central function switching" object). This memory value is saved in the volatile memory, which means that after a device reset (mains voltage return or an ETS programming operation), the value is predefined to maximum colour temperature.

tracked colour temperature value

On switching on, the internally tracked colour temperature most recently specified and in the "OFF" state is

		<p>preset. The tracked colour temperature value is not influenced by an ETS programming operation or by a bus voltage failure ("no change"). When the bus/mains voltage returns, the colour temperature active most recently before the bus/mains voltage failure is restored. Hence, this colour temperature is taken into account as a colour temperature value to be tracked when switching on.</p>
	<p>Set colour temperature value</p>	<p>The colour temperature in the selection box next to the specified parameter is set after receipt of an ON telegram via the "Switching" communication object or after receipt of a central telegram with the polarity "activated".</p>
<p>Presetting the behaviour of the colour temperature after an ETS programming operation</p>	<p>no change</p>	<p>The behaviour of the colour temperature after an ETS programming operation is permanently set to "no change". After an ETS programming operation, the DALI Gateway does not transmit any colour temperatures to the DALI operating devices. This means that the assigned DALI operating devices remain in the colour temperature most recently specified.</p>
<p>Setting the behaviour of the colour temperature in case of bus voltage failure</p>	<p>no change</p>	<p>The behaviour of the colour temperature in case of bus voltage failure, just like the behaviour after an ETS programming operation, is permanently preset to "no change". In the case of a bus voltage failure, the DALI Gateway does not transmit any colour temperature commands to the DALI operating devices. The assigned DALI operating devices remain at the colour temperature most recently set provided that the mains voltage supply of the operating devices is still guaranteed. After bus voltage failure, it is no longer possible to control the colour temperature.</p>
<p>Behaviour of the colour temperature after bus voltage return</p>	<p>Colour temperature before bus voltage failure</p>	<p>The behaviour of the colour temperature after bus or mains voltage return is preset permanently to "Colour temperature before bus voltage failure". After bus or mains voltage return, the colour temperature set most recently before the bus or mains voltage failure by relative or absolute dimming and saved internally on bus/mains voltage failure will be tracked.</p>

Addressing -> Groups... -> [x] Group -> TW function colour temperature 1

Addressing -> Single devices... -> [x] Electronic ballast -> TW function colour temperature 1

<p>Time for relative dimming of colour temperature adjustment</p>	<p>00:00:01...00:00:05... 05:59:59 [hh:mm:ss]</p>	<p>Relative dimming of the colour temperature can be triggered by the 4-bit "Relative colour temperature" communication object available for each group or single device. The data format of the "dimming" object - as well as with relative dimming of the brightness - complies with the KNX standard DPT 3.007, which means that the dimming direction and relative dimming increments can be predefined in the dimming telegram or dimming procedures can also be stopped. A relative dimming operation allows a colour temperature value to be changed constantly and always starts from the colour temperature that is set at the time of the dimming command. In the plug-in of the DALI Gateway, the dimming speed for relative dimming of the colour temperature can be configured here for a group and single device and independent of the dimming speed for a brightness change.</p>
---	--	--

Behaviour of the colour temperature by relative dimming when OFF

A relative dimming telegram for controlling the colour temperature can also switch on a group or single device in the "OFF" state. In the plug-in of the DALI Gateway, the behaviour in the "OFF" state when receiving a relative dimming telegram can be set separately for each group and each single device by this parameter.

Colour temp. value change is ignored

The DALI group or the single device in the "OFF" state is not switched on by the relative dimming telegram. The group or single device remains switched off and only tracks the dimming operation internally based on the last valid colour temperature currently set.

Colour temp. value change switches ON (standard)

The DALI group or the single device in the "OFF" state is switched to the switch-on brightness by a relative dimming telegram of the colour temperature telegram. The dimming operation for the colour temperature starts at the colour temperature value most recently set by the Gateway or which was tracked in the "OFF" state. The relative dimming telegram that leads to switching on, specifies the dimming direction and dimming

		increment. The dimming operation stops after reaching the specified colour temperature.
Dimming behaviour after receipt of a colour temperature		This parameter defines the dimming behaviour for absolute dimming using the "Absolute colour temperature (K)" object for a group or single device.
Dimming behaviour after receipt of a colour temperature	jumping to	As soon as a new colour temperature value is received it will be instantly jumped to.
Dimming behaviour after receipt of a colour temperature	dimming to	Once a new colour temperature value is received, it is set by means of the calculated dimming increment time for absolute dimming.
Time for absolute dimming of colour temperature adjustment	00:00:01... 00:00:05 ... 05:59:59 [hh:mm:ss]	<p>Absolute dimming is triggered by specifying a colour temperature value. This value can be predefined by the 2-byte "Absolute colour temperature (K)" communication object according to KNX DPT 7.600 of the KNX, which is available separately in each group or single device. In addition, colour temperature values can also be set by the scene function or by the effect function.</p> <p>In the plug-in of the DALI Gateway, the dimming speed for absolute dimming of the colour temperature can be configured here for a group and single device and independent of the dimming speed for a brightness change.</p> <p>i When predefining a colour temperature value via the object, by a scene recall or by an effect step, it is possible to configure (separately for each) in the ETS plug-in whether the value is jumped to directly or alternatively whether it is dimmed to using a dimming time (fading time).</p>
Behaviour of the colour temperature by absolute dimming when OFF		Just as with relative dimming, an absolute dimming telegram for controlling the colour temperature can also switch on a group or single device in the "OFF" state. Here too, it may be necessary in some applications for a switched off group or switched off device to still remain off if a new colour temperature value is specified absolutely. In the plug-in of the DALI

		Gateway, the behaviour in the "OFF" state when receiving an absolute dimming telegram can be set separately for each group and each single device by this parameter.
Colour temp. value change is ignored		The DALI group or the single device in the "OFF" state is not switched by the absolute colour temperature telegram. The group or the single device remains switched off and only tracks the colour temperature value internally.
Colour temp. value change switches ON (standard)		The DALI group or the single device in the "OFF" state is switched to switch-on brightness by an absolute colour temperature telegram. If the dimming behaviour of the absolute colour temperature is configured to "jump to", the intended colour temperature value is preset. If the dimming behaviour is configured to "dim to", the dimming operation starts at the colour temperature value most recently set by the Gateway or which was tracked in the "OFF" state. The dimming operation is executed according to the set dimming time. The dimming operation stops after reaching the specified colour temperature.
Feedback of the current colour temperature?		The DALI Gateway can track the set colour temperature of a DALI group and single device via a separate 2-byte feedback object according to DPT 7.600 and can also transmit it to the bus, if the bus voltage is on.
	no	The feedback of the colour temperature is not available.
	yes	The feedback of the colour temperature is available. The object "FB absolute colour temperature (K)" is enabled.
Transmission behaviour of the current colour temperature feedback		The colour temperature feedback can be used as an active message object or as a passive status object.
	active signalling object	The feedback of the absolute colour temperature is transmitted once this it updated.
	passive status object	The feedback of the absolute colour temperature will be transmitted in response only if the feedback object is read out from the bus. No automatic telegram transmission of the feedback takes place after bus or mains voltage return.

<p>Time delay for feedback telegram after bus voltage return ?</p>	<p>no yes</p>	<p>If used as an active message object, the colour temperature feedback state is transmitted to the bus after bus or mains voltage return, but only if the DALI group or single device is also switched on (brightness unequal "0 %"). In these cases, the feedback can be time-delayed. Setting "yes" activates the delay time of the feedback in case of bus voltage return. The delay time is generally configured in the parameter node "General -> Status and feedback". This parameter is only visible in case of an actively transmitting feedback object.</p>
<p>Cyclical transmission of the feedback ?</p>	<p>no yes</p>	<p>The colour temperature feedback telegram can also be transmitted cyclically via the active message object in addition to the transmission after updating. On "yes", cyclical transmission is performed. The cycle time is generally configured in the parameter node "General -> Status and feedback". If "no", the cyclical transmission is deactivated so that the feedback telegram is transmitted to the bus only when updating the colour temperature. This parameter is only visible in case of an actively transmitting feedback object.</p>
<p>Updating of the object value for feedback of current colour temperature</p>	<p>no yes</p>	<p>Here, you can specify when the Gateway should update the feedback value for the current colour temperature in case of an actively transmitting communication object. The object value updated by the Gateway is then signalled actively to the bus. This parameter is only visible in case of an actively transmitting feedback object.</p>
<p>after each update of the inputs</p>	<p>no yes</p>	<p>The Gateway updates the feedback value in the object once a new telegram is received on the input object "Absolute colour temperature (K)", but only if the DALI group or single device is also switched on. With an actively transmitting feedback object, a new telegram is also then actively transmitted to the bus each time. The telegram value of the feedback does not necessarily have to change in the process. Hence, a corresponding colour temperature feedback is also generated on the object "Absolute colour temperature (K)" such as in the case of cyclical telegrams, for example.</p>

only if the feedback value changes

The Gateway only updates the feedback value in the object if the telegram value also changes. This only takes place, however, if the DALI group or single device is also switched on. If the telegram value of the feedback does not change when switched on (e.g. in the case of cyclical telegrams to the "Absolute colour temperature (K)" object with the same telegram value), the feedback then remains unchanged. Consequently, with an actively transmitting feedback object, no telegram with the same content will be transmitted repeatedly either. This setting is recommendable, for instance, if the "Absolute colour temperature (K)" and "FB absolute colour temperature (K)" objects are linked to an identical group address. This is often the case when activating by means of light scene push-button sensors (recall and storage function).

Addressing -> Groups... -> [x] Group -> TW function colour temperature 2

Addressing -> Single devices... -> [x] Electronic ballast -> TW function colour temperature 2

Behaviour of the colour temperature during relative dimming of the brightness

It is optionally possible to automatically change the colour temperature proportionally when dimming the brightness. This makes it possible with little project planning to simulate a thermal radiator using almost any colour temperature controllable luminaire (perception of the light source such as an incandescent or halogen lamp). The behaviour of the colour temperature during relative dimming of the brightness can be configured by this parameter for a group or for a single device.

no change of colour temperature

The relative dimming of the brightness via a 4-bit dimming telegram has no effect on the colour temperature of the group or single device. The colour temperature can only be controlled separately.

Colour temperature proportional to brightness

During relative dimming of the brightness via a 4-bit dimming telegram, the colour temperature of the group or single device is also changed proportionally. The colour temperature becomes warmer when dimming down. The colour temperature becomes colder when dimming up. The colour temperature can also be controlled separately.

Behaviour of the colour temperature during absolute dimming of the brightness

It is optionally possible to automatically change the colour temperature proportionally when dimming the brightness. This makes it possible with little project planning to simulate a thermal radiator using almost any colour temperature controllable luminaire (perception of the light source such as an incandescent or halogen lamp). The behaviour of the colour temperature during relative dimming of the brightness can be configured by this parameter for a group or for a single device.

no change of colour temperature

The absolute dimming of the brightness via a 1-byte brightness value has no effect on the colour temperature of the group or single device. The colour temperature can only be controlled separately.

Colour temperature proportional to brightness

During absolute dimming of the brightness via a 1-byte brightness value, the colour temperature of the group or single device is also changed proportionally. The colour temperature becomes warmer when dimming down. The colour temperature becomes colder when dimming up. The colour temperature can also be controlled separately.

Feedback of an invalid colour temperature?

The Gateway can display whether an externally specified colour temperature is valid (object value "ON") or invalid (object value "OFF") by means of a separate 1-bit feedback object. An invalid colour temperature exists if the specified value violates the set limits of the minimum and maximum colour temperature.

no

The feedback of an invalid colour temperature is not available.

yes

The feedback of an invalid colour temperature is available. The object "FB invalid colour temperature" is enabled.

Transmission behaviour of the feedback of an invalid colour temperature

The colour temperature feedback can be used as an active message object or as a passive status object.

active signalling object

The feedback of an invalid colour temperature is transmitted once this it updated.

passive status object

The feedback of an invalid colour temperature will be transmitted in response only if the feedback object is

		read out from the bus.
Time delay for feedback telegram after bus voltage return ?	no yes	If used as an active message object, the switching status feedback of an invalid colour temperature is transmitted to the bus after bus or mains voltage return. In these cases, the feedback can be time-delayed. Setting "yes" activates the delay time of the feedback in case of bus voltage return. The delay time is generally configured in the parameter node "General -> Status and feedback". This parameter is only visible in case of an actively transmitting feedback object.
Cyclical transmission of the feedback ?	no yes	The feedback telegram of an invalid colour temperature can also be transmitted cyclically via the active message object in addition to the transmission after updating. On "yes", cyclical transmission is performed. The cycle time is generally configured in the parameter node "General -> Status and feedback". If "no", the cyclical transmission is deactivated so that the feedback telegram is transmitted to the bus only when updating the feedback. This parameter is only visible in case of an actively transmitting feedback object.
Updating of the object value for feedback of invalid current colour temperature		Here, you can specify when the Gateway should update the feedback value for an invalid colour temperature in case of an actively transmitting communication object. The object value updated by the Gateway is then signalled actively to the bus. This parameter is only visible in case of an actively transmitting feedback object.
	after each update of the inputs	The Gateway updates the feedback value in the object once a new telegram is received on the input object "Absolute colour temperature (K)". With an actively transmitting feedback object, a new telegram is also then actively transmitted to the bus each time. The telegram value of the feedback does not necessarily have to change in the process. Hence, a corresponding "invalid colour temperature" feedback is also generated on the "Absolute colour temperature (K)" object, such as in the case of cyclical telegrams for example.
	only if the feedback value changes	The Gateway only updates the feedback value in the object if the telegram value

also changes. If the telegram value of the feedback does not change (e.g. in the case of cyclical telegrams to the "Absolute colour temperature (K)" object with the same telegram value), the feedback then remains unchanged. Consequently, with an actively transmitting feedback object, no telegram with the same content will be transmitted repeatedly either.

4.2.5.4 Parameters for scenes and effects

Description	Values	Comment
☐↵ Scenes -> [x] Scene (x = 1...16)		
Name	0...28 characters Scene	Here, the scene can be assigned a unique name (e.g. "Presentation", "Large meeting"). The name planned here is displayed in the node of the scene in the left-hand plug-in window. The name is used for better orientation in the plug-in. It is not programmed into the device.
KNX number of the scene (1...64)	1...64	Scenes possess KNX numbers (1...64). These KNX numbers can be used to recall a scene or a scene memory function using the scene extension object. The KNX numbers are configured individually for each scene here. KNX numbers must be unique. It is not possible to assign the same KNX numbers to multiple scenes. The standard setting is dependent on the selected scene.
Priority: Scene to disabling / forced position	low	As the scene function is activated for different groups and devices and can have a simultaneous impact on multiple groups or single devices, priority must be given to the disabling or forced position functions. The scene has a lower priority to the supplementary functions of the assigned groups or the assigned single devices. It is not possible to call up or save the scene if a supplementary functions is only activated for one group or one single device.
	high	The scene has a higher priority to the supplementary functions of the assigned groups or the assigned single devices. Scenes are only ever called-up or saved when a scene extension unit is received.
Overwrite scene values during ETS download?	no yes	During storage of a scene, the scene values are stored internally to non-volatile memory in the device. To prevent the stored values from being replaced during ETS programming of the application or of the parameters by the originally programmed scene brightness values, the DALI Gateway can inhibit overwriting of the scene values (setting: "no"). As an alternative, the original values can be reloaded into

		the device during each ETS programming operation (setting: "yes").
Behaviour when recalling a scene	<p>jumping to</p> <p>dimming to 0.7 s</p> <p>dimming to 1.0 s</p> <p>dimming to 1.4 s</p> <p>dimming to 2.0 s</p> <p>dimming to 2.8 s</p> <p>dimming to 4.0 s</p> <p>dimming to 5.7 s</p> <p>dimming to 8.0 s</p> <p>dimming to 11.3 s</p> <p>dimming to 16.0 s</p> <p>dimming to 22.5 s</p> <p>dimming to 32.0 s</p> <p>dimming to 45.3 s</p> <p>dimming to 64.0 s</p> <p>dimming to 90.5 s</p>	<p>In the scene configuration, it is possible to define whether the scene values for the assigned groups or single devices jump instantly or dim. A scene recall can therefore be executed independently of the set dimming behaviour.</p> <p>On dimming, the fading time can also be specified (DALI-specific). This time guarantees that all the DALI groups and devices reach the specified brightness values and colour temperature values at the same time when a scene is recalled. Example: In the setting "Dim to 2.0 s", a dimming operation to set a scene brightness takes exactly 2 seconds, irrespective of the brightness or colour temperature, before the dimming operation takes place.</p>
Delay scene recall?	<p>no</p> <p>yes</p>	<p>A scene is recalled via the scene extension object. If needed, the scene recall on the Gateway can be made with a delay after reception of a recall telegram (setting: "yes"). The recall is alternatively made immediately on reception of the telegram (setting: "no"). A recall delay has no influence on the storage of scene values.</p>
Delay time [hh:mm:ss]	<p>00:00:01...00:00:05...</p> <p>05:59:59</p> <p>[hh:mm:ss]</p>	<p>The time delay during a scene recall is defined here. This parameter is only visible, if the parameter "Delay scene recall ?" is configured to "yes".</p>
<p><input type="checkbox"/> Effects</p> <p>Start effects by timer?</p>		<p>Effects can start and stop automatically depending on the time and weekday if necessary. This function is implemented by a simple timer. If the timer function is</p>

		to be used, this must be enabled globally.
	no (start only by object)	The timer function is not available. Effects can be started and stopped exclusively via the communication objects (1-bit or 1-byte extension) or via the DALI test function.
	yes (start by timer or object)	The timer function is enabled globally. Effects can be assigned to the particular parameter pages of the timer function by configuring start and stop times. In addition to controlling via the timer, effects can always be started and stopped as well via the communication objects (1-bit or 1-byte extension) or DALI test function.
Data format for time and date of the timer		To ensure that the timer can process the configured start and stop times, the current time and current weekday must be transmitted to the Gateway via the KNX. The data format for providing this information can be set here.
	3-byte 'weekday / time' (DPT 10.001)	The current time and weekday for the timer is provided by a 3-byte object according to KNX DPT 10.001.
	8-byte 'date / weekday / time' (DPT 19.001)	The current time and weekday for the timer is provided by an 8-byte object according to KNX DPT 19.001. The date contained in the telegram is irrelevant and is rejected by the timer.
		i To ensure high accuracy, we recommend setting the time of the timer via a KNX telegram at least once a day.
<input type="checkbox"/> Effects -> [x] Effect		
Name	0...28 characters Effect	Here, the effect can be assigned a unique name (e.g. "Effect window", "Effect entrance"). The name planned here is displayed in the node of the effect in the left-hand plug-in window. The name is used for better orientation in the plug-in. It is not programmed into the device.
Priority: Effect to disabling / forced position		As the effect function is activated for different groups and devices and can have a simultaneous impact on multiple groups or single devices, priority must be given to the disabling or forced position functions.
	low	

		<p>The effect has a lower priority to the supplementary functions of the assigned groups or the assigned single devices. It is not possible to recall or save an effect if a supplementary function is only activated for one group or one single device.</p>
	high	<p>The effect has a higher priority to the supplementary functions of the assigned groups or the assigned single devices. The effect can be started if a disabling or forced position function is active.</p>
KNX number of the effect (1...64)	1...64	<p>Just like scenes, effects possess KNX numbers (1...64). These KNX numbers can be used to start and also stop individual effects using the extension object of the effect function. The KNX numbers are configured individually for each effect. KNX numbers must be unique. It is not possible to assign the same KNX numbers to multiple effects. The standard setting is dependent on the selected effect.</p>
Number of steps (1...16)	1...16	<p>In particular, for the implementation of dynamic light scenes, it is possible to include lights or light groups in the effect control of the DALI Gateway. Up to 16 effects are available here, each with up to 16 effect steps. Each effect step represents an individual light scene. Time-controlled toggling of the effect steps makes the overall effect dynamic. Brightness sequences can be implemented using one or more DALI groups, or also using individual DALI devices or scenes.</p> <p>Up to 15 effect steps can be created for each effect, as necessary. The last step of an effect is always the stop step in the configuration. This is only executed when the effect is stopped automatically after the number of run-throughs (ETS parameter) has been reached, or the user performs the Stop command via communication objects. A new effect step can be added by selecting an effect parameter node in the tree view and then executing the New command in the context menu.</p> <p>This parameter shows the number of effect steps in the effect. It cannot be edited.</p>
	0...1...500	<p>An effect always starts at effect step 1. The steps are processed in sequence,</p>

<p>Number of run-throughs (1...500) (0 = infinite)</p>		<p>according to their number. An effect run-through corresponds to calling up all the steps created in the effect. The number of run-throughs can be specified individually here between 1...500. An effect stops automatically when the configured number of run-throughs has been reached. Otherwise the effect starts again with the first step after processing of the last effect step.</p>
<p>Set start time?</p>	<p>no yes</p>	<p>Once the timer function has been enabled globally under "Effects", all or individual effects can be assigned to the timer independently of one another. Each effect will then have a start and stop time. This parameter enables the start time and thus allows the time-controlled starting of an effect.</p>
<p>Effect start time</p>	<p>Mon, Tue, Wed, Thu, Fri, Sat, Sun Time 00:00:00 [hh:mm:ss]</p>	<p>This parameter defines the start time and determines on which weekdays the start time should be evaluated. This parameter is only visible with "Set start time ? = yes".</p>
<p>Set stop time?</p>	<p>no yes</p>	<p>Once the timer function has been enabled globally under "Effects", all or individual effects can be assigned to the timer independently of one another. Each effect will then have a start and stop time. This parameter enables the stop time and thus allows the time-controlled stopping of an effect.</p>
<p>Effect stop time</p>	<p>Mon, Tue, Wed, Thu, Fri, Sat, Sun Time 00:00:00 [hh:mm:ss]</p>	<p>This parameter defines the stop time and determines on which weekdays the stop time should be evaluated. This parameter is only visible with "Set stop time? = yes".</p>
<p>Use disabling function for timer?</p>	<p>no yes</p>	<p>Disabling functions allow deactivation of the timer if necessary and can thus inhibit an automatic start or stop command. The configured start and stop times of an effect are not processed during an active disabling function. It is only possible to start or stop an effect during an active disabling function by the communication objects or via the</p>

		<p>DALI test function. This parameter enables the disabling function.</p>
<p>Polarity of disabling function for timer</p>	<p>0 = enable / 1 = disabled</p> <p>1 = enable / 0 = disabled</p>	<p>The polarity of the disabling object is defined here. This parameter is only available if the disabling function is enabled.</p> <p>i The disabling functions are always deactivated (object value = "OFF") after a device reset. If the parameter "Polarity disabling object for timer" is configured to "1 = enable / 0 = disabled", an "OFF" telegram must first be sent to the disabling object after a device reset so that the disabling function is activated.</p>
<p>Behaviour at the beginning of the disabling function</p>	<p>no change</p> <p>Stop effect</p>	<p>The behaviour of an effect can be defined at the beginning of the associated disabling function. In the "no change" setting, the execution of the start and stop times is inhibited by the timer immediately at the beginning of the disabling function. This reaction also takes place in the "Stop effect" setting. Additionally, the effect is then also stopped.</p>
<p>Behaviour at the end of the disabling function</p>	<p>no change</p> <p>Start effect</p> <p>Stop effect</p>	<p>The behaviour of an effect can be defined at the end of the associated disabling function. In the "no change" setting, the execution of the start and stop times is enabled again by the timer at the end of the disabling function. The timer does not repeat any start or stop times that were suppressed during an active disabling function. In the "Start effect" setting, the effect is additionally started. The stopping of the effect at the end of the disabling function can be specifically induced by the "Stop effect" setting.</p>
<p><input type="checkbox"/> Effects -> [x] Effect -> [y] Step</p> <p>Behaviour when recalling the effect step</p>	<p>jumping to</p> <p>dimming to 0.7 s</p> <p>dimming to 1.0 s</p>	<p>In the configuration of an effect step, it is possible to specify whether the brightness values and colour temperature values for the assigned groups, single devices are recalled either with an instant jump or are</p>

	dimming to 1.4 s	<p>dimmed to. The recall of an effect step can thus be executed independently of the set dimming behaviour of the groups or single devices.</p> <p>On dimming, the fading time can also be specified (DALI-specific). This time guarantees that, when an effect step is recalled, all the DALI groups and devices reach the specified values at the same time. Example: In the setting "Dim to 0.7 s", a dimming operation to set a brightness takes exactly 0.7 seconds, irrespective of the brightness before the dimming operation takes place.</p>
	dimming to 2.0 s	
	dimming to 2.8 s	
	dimming to 4.0 s	
	dimming to 5.7 s	
	dimming to 8.0 s	
	dimming to 11.3 s	
	dimming to 16.0 s	
	dimming to 22.5 s	
	dimming to 32.0 s	
	dimming to 45.3 s	
	dimming to 64.0 s	
	dimming to 90.5 s	
Delay until next step [hh:mm:ss.100ms]	00:00:00. 0... 00:00:00.10. 0... 23:59:59. 9 [hh:mm:ss.100ms]	<p>During an effect run-through, effect steps are processed in sequence, according to their number. Once all the brightness values and colour temperature values of an effect step have been set, the effect controller waits for the set "Delay until the next step". Then the next step is recalled.</p> <p>In the "00:00:00.0" setting, the individual steps are recalled without delay after their processing. The "Delay until next step" is only started when the last assignment of an effect step has been processed.</p> <p>This parameter is not available for a stop step.</p>

4.2.5.5 Parameters for emergency lights

Description	Values	Comment
<p>☐ Emergency lights</p> <p>Emergency lights system</p>	<p>centrally supplied</p>	<p>No emergency lights with special DALI operating devices are used in an emergency lighting system, supplied by group or central battery systems. Instead, standard devices are used according to the basic DALI standards. These devices, which are primarily intended to control general DALI lighting systems, usually only possess one mains voltage connection and do not possess a battery for self-supply, should the mains voltage fail. The DALI Gateway supports the control of centrally supplied DALI emergency lights. This parameter cannot be changed.</p>
<p>Feedback "Emergency lights overall status" ?</p>	<p>no</p> <p>yes</p>	<p>The DALI Gateway is able to evaluate the operating status of all the DALI operating devices integrated into the emergency operation in accordance with the transferred error status, and to make them available collectively to other KNX devices in the form of 1-bit feedback via the object "Feedback, emergency lights, complete". The status of all the electronic ballasts integrated into centrally-supplied and single-battery-operated emergency operation is evaluated - provided that these systems are intended in the configuration. If the Gateway only detects a malfunction of only one operating device or of multiple operating devices, it will set the object value to "1". Otherwise (error-free system), the object value is set to "0". In the "yes" setting, this parameter enables the complete status feedback.</p>
<p>Type of feedback</p>	<p>active signalling object</p> <p>passive status object</p>	<p>The complete status feedback can be used as an active message object or as a passive status object. As an active message object, the feedback information is also directly transmitted to the bus whenever there is an update. As a passive status object, there is no telegram transmission after an update. In this case, the object value must be read out. The ETS automatically sets the object communication flags required for proper functioning. This parameter is only visible if complete status feedback is enabled.</p>

<p>Time delay for feedback telegram after bus voltage return ?</p> <p style="text-align: right;">no yes</p>	<p>If used as an active message object, the complete status feedback state is transmitted to the bus after bus or mains voltage return or after programming with the ETS, should an error be present. In these cases, the feedback telegram can be time-delayed with the delay being preset globally for all device feedback together. If a time delay is required, this parameter must be set to "yes". Otherwise ("no" setting), transmission of the active message telegram takes place immediately after a device reset and if there is an error. This parameter is only visible if complete status feedback is enabled and the message object is actively transmitting.</p>
<p>Cyclical transmission of the feedback ?</p> <p style="text-align: right;">no yes</p>	<p>Optionally, the complete status feedback, in its function as an active signalling object, can also be transmitted cyclically, in addition to transmission on an update. This parameter specifies whether cyclical transmission is enabled or not. If enabled, the parameter "Time for cyclical transmission" on the same parameter page will define the cycle time. This parameter is only visible if complete status feedback is enabled and the message object is actively transmitting.</p>
<p>Time for cyclical transmission</p> <p style="text-align: right;">00:00...15:00...59:59 [mm:ss]</p>	<p>This parameter defines the time for the cyclical transmission of the complete status feedback. It is only visible if overall feedback is enabled and the message object is actively transmitting.</p>
<p><input type="checkbox"/> Emergency lights -> Centrally-supplied</p> <p>Scope of emergency operation</p> <p style="text-align: right;">Emergency lights</p>	<p>In centrally-supplied emergency lighting systems, a distinction is made as to which parts of the electrical building installation are supplied by the emergency power supply. The parameter defines the version of the emergency lighting system.</p> <p>In this application, either all or just individual DALI operating devices are connected to the emergency power supply. The KNX system and DALI Gateway are not supplied with emergency power, which means that if the mains voltage fails, these subsystems will no longer function. If there is a fault, there is no DALI voltage</p>

Emergency lights & KNX system

because the power supply of the Gateway is no longer working.

In this application, all or individual DALI operating devices as well as the power supply of the KNX system are connected to the emergency power supply. The DALI Gateway is not supplied with emergency power, which means that it will no longer function if the mains voltage fails. If there is a fault, there is no DALI voltage because the power supply of the Gateway is no longer working. Since the KNX system continues working without interruption if the mains power fails, mains failure messages that the Gateway can produce before switch-off (feedback of supply voltage failure) can be evaluated and processed.

Emergency lights & KNX system & DALI Gateway

In this application, all or individual DALI operating devices, the power supply of the KNX system and the mains voltage connection of the DALI Gateway are connected to the emergency power supply. If there is a fault, DALI voltage will remain since the power supply of the Gateway continues working. This application offers the greatest flexibility, since the DALI Gateway can continue to control the operating devices. In this application, the DALI operating devices do not switch automatically to the "System Failure Level". Instead, the Gateway controls selected operating devices at a special brightness value for emergency operation. This brightness can be configured in the ETS plug-in within the limits of minimum and maximum brightness if necessary. Alternatively, it is possible to define no special behaviour at the beginning of emergency operation. In this case, the operating devices assigned to emergency operation remain at the last set brightness value.

Emergency lights -> Centrally-supplied -> Emergency lights & KNX system & DALI Gateway

Monitoring for the failure of the general power supply ?

Failure message DALI (internal)

If the scope of emergency operation also allows for the integration of the DALI Gateway, the Gateway will activate emergency operation. It instigates all the appropriate actions on the KNX and the DALI page. Identification of a mains failure as the cause of emergency operation can take place in different ways. Either the Gateway automatically identifies whether mains voltage is present (internal failure messages) or not using the diagnosis of the DALI

Failure message KNX (external)

Failure message DALI OR KNX (internal OR external)

Failure message DALI AND KNX (intern AND extern)

		<p>operating devices. This is possible through contacting and reading out all commissioned DALI devices. If a number of these devices specified by the programmer do not respond, the Gateway will assume that the mains voltage has failed.</p> <p>In addition, or alternatively, a KNX telegram can inform the Gateway that emergency operation is to be activated (external failure message). This is useful, for example, when a KNX binary input is monitoring the mains voltage and transmits a message telegram if there is a mains failure.</p> <p>This parameter defines whether the detection of a mains voltage failure will take place using an internal DALI failure message or, alternatively, using an external KNX failure message. Both options can be combined and linked logically (AND, OR), which means that a higher guarantee of detection or redundancy can be implemented during failure detection.</p>
<p>Minimum number of failed devices</p>	<p>1...64</p>	<p>With the internal DALI failure message, all the planned and commissioned DALI operating devices are polled cyclically (same interval in seconds as for determining the error status). Should one of the devices no longer respond to the Gateway, the operating device concerned will be saved internally as "failed". As a result, the DALI Gateway will assume that the mains voltage supply of the DALI operating device has failed.</p> <p>This parameter can be used to define how many devices must be identified as "failed" for the Gateway to activate emergency operation. If the number of failed devices reaches or exceeds the configured limit value, then failure of the general mains power supply is assumed. If the limit value was not reached, the Gateway will remain in normal operation.</p> <p>This parameter is only visible if an internal DALI failure message is intended.</p>
<p>Message: Failure, general supply</p>	<p>no yes</p>	<p>A 1-bit failure telegram can be transmitted to the KNX as feedback either through the internal failure message, or alternatively, through the external failure message, provided that the Gateway has activated emergency operation. This allows other bus devices</p>

		<p>evaluating this feedback (e.g. other KNX DALI Gateways) to react and also activate emergency operation. Automatic identification of a mains voltage failure is usually not necessary with these devices, which means that only one DALI Gateway in the KNX system needs to be integrated actively into mains failure detection.</p>
Reaction to external message" enable "Emergency operation" ?	<p>no</p> <p>yes</p>	<p>The DALI Gateway does not need to monitor its own DALI system or external failure messages itself in order to identify the failure of the general mains voltage supply and thus to activate emergency operation. Optionally, it can be switched to emergency operation by an external message. When using the external message, only one DALI Gateway (Master) in the KNX system needs to be integrated actively into mains failure detection. All other Gateways - if available - will then evaluate the external feedback of this Master. Alternatively, a Gateway can be controlled using the external message from any KNX device.</p>
Behaviour of the brightness at the end of emergency operation	<p>OFF</p> <p>Brightness value</p> <p>no change</p> <p>Brightness before emergency operation</p> <p>tracked brightness value</p>	<p>If the Gateway deactivates emergency operation (due to internal or external failure monitoring of the mains voltage or an external message telegram), all the DALI groups or single devices integrated in the centrally-supplied emergency operation are switched to defined brightness states. This parameter defines the behaviour at the end of emergency operation. This means that the switching off or the activation of a defined brightness value can be configured. Alternatively, the brightness value active before emergency operation or the brightness value tracked internally during emergency operation can be set. As a final alternative, it is possible to retain the current state of all operating devices.</p>
Behaviour of the colour temperature at the end of emergency operation	<p>no change</p> <p>tracked colour temperature value</p> <p>Colour temperature value</p>	<p>The colour temperature can be influenced at the end of emergency operation so that either a colour temperature value is specified or the internally tracked colour temperature is set during emergency operation. As a further option, the effective colour temperature during active emergency operation can remain unchanged at the end of emergency operation.</p>

Delay time at the end of emergency operation [mm:ss]	00:00... 01:00 ...59:59 [mm:ss]	This parameter is only available if the integration of tunable white lights is provided for and at least one device (individually addressed and group-controlled) is configured to the device type "Control gear for colour control (Tunable White)" or "Multitype".
<input type="checkbox"/> Emergency lights -> Centrally-supplied -> Emergency lights & KNX system & DALI Gateway -> Feedback, emergency operation	no yes	Deactivation of emergency operation and thus the execution of the behaviour at the end of emergency operation can take place after a delay. A time delay is advisable in order to give DALI operating devices without an emergency current supply sufficient time after the return of mains voltage to switch on at the operating brightness. The delay time means that DALI emergency lights are only switched off or switched to normal operation when the standard lighting is ready for operation. The parameter "Delay time at the end of emergency operation" defines the period of time from the identification of the return of mains voltage until the actual deactivation of emergency operation. In the "00:00" setting, emergency operation is deactivated without a delay.
Feedback "Emergency operation status" ?	no yes	The DALI Gateway is able to make the state of emergency operation available on the KNX in the form of 1-bit feedback via the object "Feedback, emergency operation status". This allows other KNX bus devices to be informed about emergency operation in order to control displays for users (e.g. in a visualisation) or to carry out further actions (e.g. remote forwarding via the telephone or IP data network through suitable KNX components). If emergency operation is activated, the Gateway sets the object value to "1". Otherwise (emergency operation deactivated), the object value is set to "0". In the "yes" setting, this parameter enables the feedback "Emergency operation status".
Type of feedback	active signalling object passive status object	The "Emergency operation status" feedback can be used as an active message object or as a passive status object. As an active message object, the feedback information is also directly transmitted to the bus whenever there is

		<p>an update. As a passive status object, there is no telegram transmission after an update. In this case, the object value must be read out. The ETS automatically sets the object communication flags required for proper functioning.</p> <p>This parameter is only visible if the feedback "Emergency operation status" is enabled.</p>
Time delay for feedback telegram after bus voltage return ?	no yes	<p>If used as an active message object, the status feedback state is transmitted to the bus after bus or mains voltage return or after programming with the ETS, provided that emergency operation is activated. In these cases, the feedback telegram can be time-delayed with the delay being preset globally for all device feedback together. If a time delay is required, this parameter must be set to "yes". Otherwise ("no" setting), transmission of the active message telegram takes place immediately after a device reset and if there is an error.</p> <p>This parameter is only visible if the feedback "Emergency operation status" is enabled and the message object is actively transmitting.</p>
Cyclical transmission of the feedback ?	no yes	<p>Optionally, the "Emergency operation status" feedback in its function as an active signalling object can also be transmitted cyclically, in addition to transmission on an update. This parameter specifies whether cyclical transmission is enabled or not. If enabled, the parameter "Time for cyclical transmission" on the same parameter page will define the cycle time.</p> <p>This parameter is only visible if the feedback "Emergency operation status" is enabled and the message object is actively transmitting.</p>
Time for cyclical transmission	00:00... 15:00 ...59:59 [mm:ss]	<p>This parameter defines the time for the cyclical transmission of the "Emergency operation status" feedback. It is only visible if feedback is enabled and the message object is actively transmitting.</p>

5 Appendix

5.1 Index

Icons

"partial DALI commissioning"..... 167-168

A

Activating switch-off delay..... 119
 Addressing types..... 40
 Automatic switch-off..... 117

B

brightness range..... 80
 broadcast manual operation..... 15
 bus voltage failure..... 99,102
 bus voltage return..... 100,102

C

Central function..... 79
 Collective feedback..... 68
 commissioning adjustment..... 178
 Compatibility mode..... 175
 continuous lighting..... 126
 Controls and indicators..... 14

D

DALI device replacement..... 77
 DALI device type..... 47
 DALI emergency lighting systems..... 48
 DALI groups..... 53
 DALI short-circuit..... 67
 DALI system..... 39
 DALI test..... 188
 Delay time..... 60
 Delivery state..... 195
 Dimming characteristic..... 81,83
 dimming speeds..... 81,92

E

effect run-throughs..... 145
 effect steps..... 54
 effects..... 54
 emergency lighting systems..... 48
 Emergency lights overall status..... 153
 Emergency lights system..... 153
 error status..... 62
 ETS programming operation..... 98,101
 ETS search paths..... 21
 export..... 55

G

group assignment..... 168

I

Import..... 55

K

KNX numbers..... 55

M

mains voltage return..... 60
 manual operation..... 74
 maximum brightness..... 81
 maximum colour temperature..... 91
 minimum brightness..... 80
 minimum colour temperature..... 90

O

Offline commissioning..... 181
 operating hours counter..... 131

P

Performing a DALI device replacement 19
 Power-On Level..... 100
 Print function..... 58
 Priorities..... 15

S

Safe-state mode..... 25
 scene brightness values and colour temperature values 137
 Scenes..... 54
 Setting a KNX effect number..... 144
 Setting a KNX scene number..... 136
 Setting disabling function..... 104
 Setting forced position function..... 105
 Setting the effect priority..... 145
 Setting the pre-warning function..... 125
 Setting the scene priority..... 139
 single device assignment..... 174
 single devices..... 53
 Soft ON/OFF..... 119
 Staircase function..... 122
 Supplementary function..... 104
 switch-off brightness..... 118
 switch-on brightness..... 81

switch-on colour temperature.....	91
switch-on delay.....	119
System Failure Level.....	48,99

T

telegram rate limit.....	60
temperature range.....	90
thermal radiator.....	94
time	149
Time delay.....	60
Time delays.....	119
Timer.....	149

W

weekday.....	149
--------------	-----

ALBRECHT JUNG GMBH & CO. KG

Volmestraße 1
58579 Schalksmühle
GERMANY

Telefon: +49 2355 806-0
Telefax: +49 2355 806-204
kundencenter@jung.de
www.jung.de