

Smart Visu Server



Ref. no.: SV-SERVER-01
SV-SERVER-INT



Product Documentation



Product Documentation

Smart Visu Server

SV-SERVER-01
SV-SERVER-INT



ALBRECHT JUNG GMBH & CO. KG

Volmestraße 1
D-58579 Schalksmühle

Tel: +49 (0) 23 55/80 60
Fax: +49 (0) 23 55/80 61 89
kundencenter@jung.de
<https://www.jung.de/en/>

Service Centre

Kupferstr. 17-19
44532 Lünen
Germany

1	COMMISSIONING THE SMART VISU SERVER	4
1.1	Correct use	4
1.2	Product characteristics	5
1.3	Scope of delivery	6
1.4	Technical data	6
1.5	Structure of the device, function	7
1.6	System information.....	8
1.7	Installation, commissioning.....	9
	1.7.1 SV-Home – User interface	10
	1.7.2 SV-Control – Project Design interface	11
1.8	Warranty.....	12
2	SV-CONTROL	13
2.1	Project tab.....	13
	2.1.1 Manage language	13
	2.1.2 Start.....	13
	2.1.3 Backing up a project	13
	2.1.4 Restoring a project.....	14
	2.1.5 Password protection	14
	2.1.6 SV-Home.....	17
	2.1.7 Product Documentation	17
2.2	KNX.....	18
	2.2.1 Defining the KNX-IP Gateway.....	18
	2.2.2 Importing the KNX-OPC project file	19
2.3	Hue.....	20
	2.3.1 Defining the Hue-IP Gateway	20
	2.3.2 Importing Hue lamps.....	21
2.4	SONOS	26
	2.4.1 Inserting SONOS devices	26
2.5	Area & Functions	29
	2.5.1 Creating a new area.....	30
	2.5.2 Editing or deleting areas	31
	2.5.3 Creating a new function	32
	2.5.4 Configuring KNX functions.....	34
	2.5.5 SONOS	110
	2.5.6 Weather.....	111
	2.5.7 Configuring Philips Hue functions	118
	2.5.8 Configuring websites / IP functions	120
	2.5.9 Configuring status logic functions	130
	2.5.10 Configure virtual functions	131
	2.5.11 Email	132
	2.5.12 Editing or deleting a function.....	133
2.6	Action	134
	2.6.1 Creating action groups.....	134
	2.6.2 Creating an action	136
	2.6.3 Editing or deleting an action.....	140
	2.6.4 Point in time overview of the actions	141
	2.6.5 SV-Home Options	141
2.7	Configuration management	142
	2.7.1 Network settings	143
	2.7.2 Setting the system time and date	144
	2.7.3 MyJUNG Konto	145
	2.7.4 Remote access	145
	2.7.5 Amazon Alexa	152
	2.7.6 Email message	153
	2.7.7 Server update	154
3	SV-HOME	155
3.1	SV-Home settings	156
	3.1.1 Language	157
	3.1.2 Columns setting	157

3.1.3	Design	158
3.1.4	Start page.....	158
3.1.5	Font size.....	159
3.1.6	Presentation labels	159
3.2	SV-Server app for Android.....	160
3.3	SV-Server app for iOS	161
4	UPDATE OF THE SMART VISU SERVER.....	162
4.1	Reading out the software version	162
4.2	Performing a system update.....	162
5	APPLICATION EXAMPLES	163
6	MAINTAINING THE SMART VISU SERVER	164
7	APPENDIX.....	164
7.1	Accessories	164
8	COPYRIGHT	165
8.1	Open Source Licences	166
8.1.1	GNU GENERAL PUBLIC LICENCE Version 2 (GPL v2)	166
8.1.2	GNU GENERAL PUBLIC LICENCE Version 3 (GPL v3)	172
8.1.3	GNU LESSER GENERAL PUBLIC LICENCE Version 3 (LGPL).....	183
8.1.4	Eclipse Public Licence - v 2.0	186

1 Commissioning the Smart Visu Server

Safety instructions



WARNING

Failure to comply with these instructions may result in damage to the device, fire or other hazards. These instructions are a component part of the product and must remain with the end customer. Electrical equipment must only be installed and mounted by qualified electricians. This product is only intended for use in dry rooms.

1.1 Correct use

- Visualisation and operation of KNX systems via terminals with HTML5-compatible browsers (Firefox, Chrome, Safari, Opera) or app (iOS, Android), e.g. smartphone, tablet, laptop, PC etc.
- Visualisation and operation of Philips Hue systems
- Operation in local IP networks, which support DHCP (Dynamic Host Configuration Protocol), or with fixed IP address (IPv4)
- Interior operation

1.2 Product characteristics

- Web visualisation of the KNX system for status display and operation (SV-Home)
- Access to the SV-Home web visualisation with max. 10 different clients (recommended)
- Integrated web-based start-up tool (SV-Control)
- Simple creation of a preconfigured operating desktop, optimised for applications at home and in small commercial buildings
- Graphical operating elements, selection of icons from supplied libraries
- Import of group addresses (three-level) via OPC import (ETS3, ETS4, ETS5)
- Manual input of group addresses possible
- 24 areas
- 240 dynamic functions (max. 1200 data points)
 - o Switch
 - o Dimming
 - o Tunable White
 - o Coloured light
 - o Stairway function
 - o Threshold
 - o Value transmitter
 - o Multimedia
 - o Motor
 - o Climate
 - o Status / Value
 - o Website
 - o Webcam
 - o State logic
 - o Email notification
 - o Weather
- 25 actions groups
- 250 configurable actions (max. 16 functions per action)
 - o User-defined
 - o Point in time
 - o Event
 - o Astro
- Connection to the KNX-BUS via KNX-IP router or KNX-IP interface
- Integration of Philips Hue systems in the KNX system
- Connection to Philips Hue via the Philips Hue Bridge
- Integration of SONOS speakers in the KNX installation
- Integration of the Amazon Alexa language service via a MyJUNG account
- Paid remote access via a MyJUNG account
- Updateable and upgradeable

1.3 Scope of delivery

- Smart Visu Server including software
- Retaining bracket for wall or support rail mounting
- Operating instructions
- Power supply unit with plug
 - o SV-SERVER: EU power supply unit (Euro plug)
 - o SV-SERVER-01: Power supply unit, including adapter for BS (United Kingdom), EU (Euro plug) and CN (China)
 - o SV-SERVER-INT: Power supply unit, including adapter for BS (United Kingdom), EU (Euro plug) and CN (China)

Legal information

Philips and Hue are registered trademarks of Koninklijke Philips Electronics NV.

This product contains Open Source software components, which are subject to the conditions of Copyright and/or the licence agreements of third parties. The licence information is located on the Smart Visu Server.

1.4 Technical data

Rated voltage:	DC 12 V SELV
Power consumption:	Typ. 3 W, max. 7 W
Ambient temperature:	-5 ... +45 °C
Storage/transport temperature:	-25 ... +70 °C
LAN:	RJ45 socket (10/100 Mbit/s Fast Ethernet) CAT5
USB:	USB 2.0 Host
Dimensions:	124 x 72 x 31 mm (without retaining unit) 124 x 92 x 40 mm (with retaining unit)
Power supply unit with plug:	
Primary voltage:	AC 100 ... 240 V ~
Mains frequency:	50 / 60 Hz
Rated current:	Max. 1 A
Secondary voltage:	DC 12 V SELV
Protection class:	II
Length of connecting cable:	1.5 m
Plug contact:	SV-SERVER: EU SV-SERVER-INT: BS,EU,CN



CAUTION

This device contains a battery (CR1632, 0.4 Wh) to back up the saved data. Do not dispose of discharged batteries with domestic waste. During transport, comply with the special regulations of the ADR and IATA.

1.5 Structure of the device, function

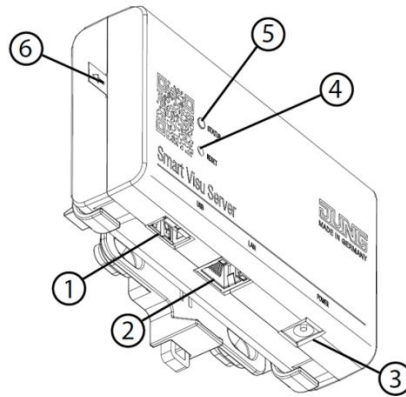


Figure 1: Structure of the Smart Visu Server

(1) USB interface	For software updates and data backup
(2) Ethernet interface	For connection to the local network
(3) Power supply	Only the power supply unit from the scope of delivery
(4) Reset button	Reset and update
(5) Status LED	Displays the current status of the server
(6) Discharge protection	Remove for operation

The status LED (5) displays the various operating states.

Colour of the status LED	Function
Flashing yellow	Server booting
Flashing red	Error pending, server stopping
Continuous dim yellow	Server and network booting
Continuous bright yellow	Server gets IP address
Continuous blue	Server ready, DHCP active
Continuous green	Server ready, static network address
Flashing blue/magenta	Update operation, DHCP active
Flashing green/magenta	Update operation, static network address

The reset button (4) triggers a reset or an update.

Reset network settings, DHCP operation active	Press the button ≥ 5 seconds, LED flashes yellow, press the button again briefly
Factory reset	Press the button for 20 seconds, LED flashes red, press the button again briefly
Initialise update operation	Press the button briefly 5x - LED turns magenta: No update available - LED flashes magenta: Update operation
Set rescue IP setting	Press the button for 10 seconds, LED flashes yellow with fast frequency, press the button again briefly

1.6 System information

The Smart Visu Server is used to visualise and operate a KNX system connected to the same network via a smartphone, tablet, laptop or PC and to control SONOS and Philips Hue systems (SV-Home). A local network is required for it to function.

The connection to the KNX is made via the KNX IP interface. The connection to the Philips Hue system is made via the Philips Hue Bridge. The connection to the SONOS system is carried out via the local network.

Start-up takes place via the web-based interface (SV-Control). The technical documentation is also available here.

The server organises KNX functions, SONOS and Philips Hue operation into areas, functions and actions.

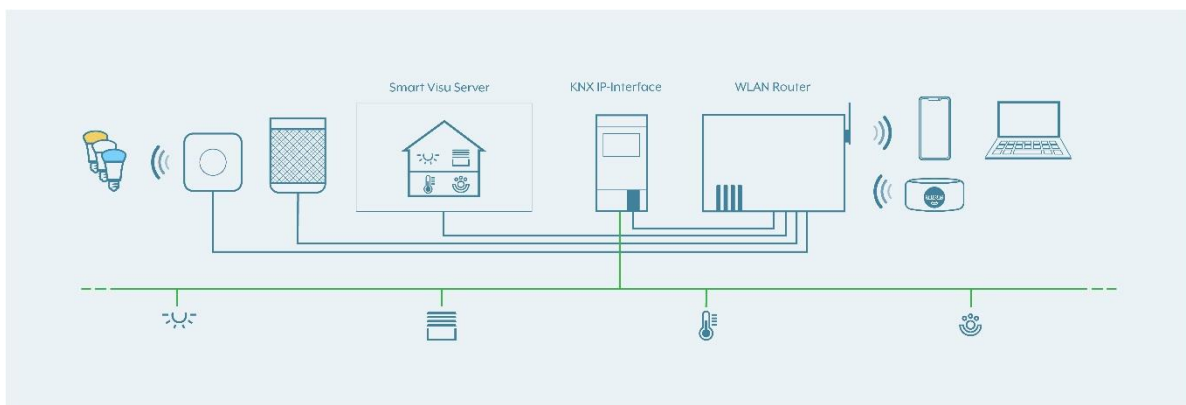
Areas: An area indicates an assignment, e.g. to a room. Up to 24 areas are possible.

Function: A function corresponds to, for example, a KNX function, thus possibly comprising multiple group addresses, e.g. switching channel with feedback. A function could also be the link to a Philips Hue lamp. Up to 240 functions can be created with up to 1200 data points. Each function can be assigned to one or more areas.

Action: An action is a grouping of one or more functions. Actions can be triggered by events, by time or via user-defined controls. Up to 250 actions are possible.

Action group: An action group is used to group individual actions. Up to 25 action groups can be activated or deactivated as required.

KNX projects can be imported from the OPC export (3-level group address) of ETS3, ETS4 or ETS5 or be created manually (see chapter 2.2.2)



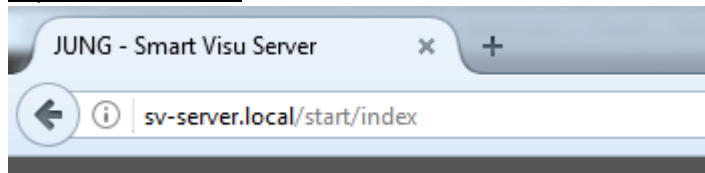
1.7 Installation, commissioning

Mounting takes place using the supplied retaining unit on the wall or on a support rail according to DIN EN 60715. The server is snapped onto the retaining unit.

A current HTML5-capable browser (input device) or the corresponding iOS / Android app is required for access to SV-Home and SV-Control. The Smart Visu Server, KNX-IP Gateway, network router (DHCP active) and input device must all be a part of the same network. During start-up, the Smart Visu Server expects the assignment of an IP address via DHCP.

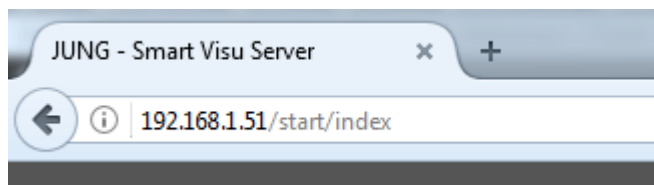
Remove the discharge protection from the server. Connect the server to the network and the power supply unit to the server. After the mains plug has been connected, the server will boot. As soon as the status LED turns blue, the server is ready for operation. In the address line of the Internet browser, enter:

<http://sv-server.local>



This opens the homepage of the server.

If your network doesn't support it, then determine the IP address of the server in the router manually. Enter the determined address, e.g. 192.168.1.51, in the address line of your Internet browser, e.g.:



This opens the homepage of the server. On the homepage, for further actions, the web-based software tool "SV-Home" (1) can be used for the visualisation and operation of the Smart Visu Server, as can "SV-Control" (2) for the configuration and commissioning of the same.

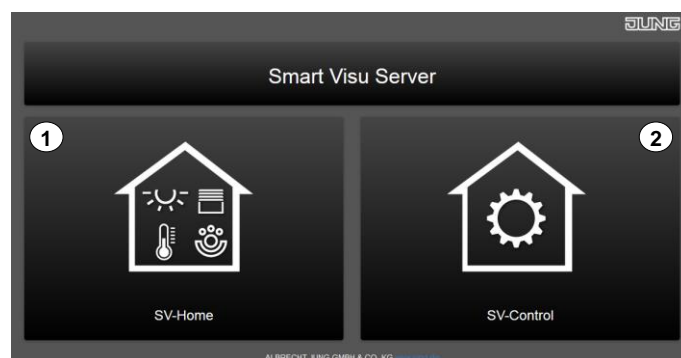


Figure 2: Homepage of the Smart Visu Server

1.7.1 SV-Home – User interface

The SV-Home is the integrated web interface of the Smart Visu Server for the visualisation, status display and operation of the KNX system, SONOS and the Philips Hue system. The SV-Home is generated automatically from the configuration set up in SV-Control.

A current HTML5-compatible (Firefox, Chrome, Safari, Opera) browser (input device) is required for access to SV-Home. The access of max. 10 different clients on the SV-Home web interface is recommended. When the server is opened, the SV-Home visualisation can be started by selecting the left button or <http://IP-address/SV-Home/> (1).

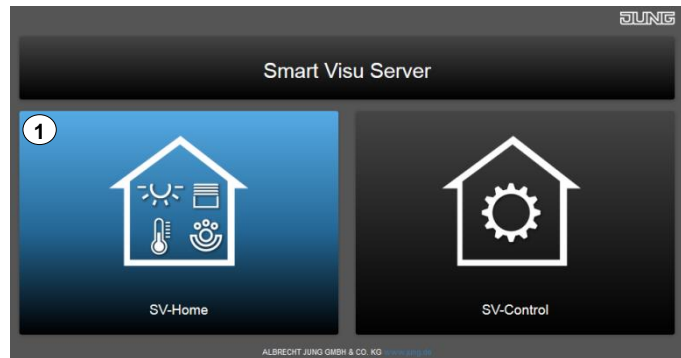


Figure 3: Opening SV-Home

The top pane (1) displays the areas created in SV-Control with the selected icon and name. It is also possible to display the defined area of the actions. Selecting an area displays the assigned functions and actions (2) beneath.



Figure 4: Structure of the SV-Home visualisation

Depending on the created function type, these functions visualise their status (e.g. the current room temperature) or offer a chance to influence it (e.g. move a venetian blind or dim a Philips Hue lamp).

1.7.2 SV-Control – Project Design interface

This subchapter is intended to help you get to know the structure of the project design interface. The following chapter describes the functions and exact procedure for project design in more detail.

SV-Control is the integrated web-based commissioning tool of the Smart Visu Server. In addition, the system configuration can be performed here.

A current HTML5-compatible browser (input device) or the corresponding iOS / Android app is required for access to SV-Control.

After calling up the SV start page, SV-Control can be started by selecting the right-hand button (1).

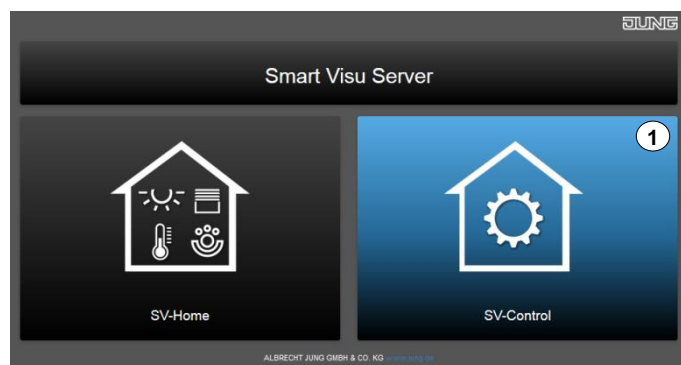


Figure 5: Opening SV-Control

The homepage of SV-Control then opens.

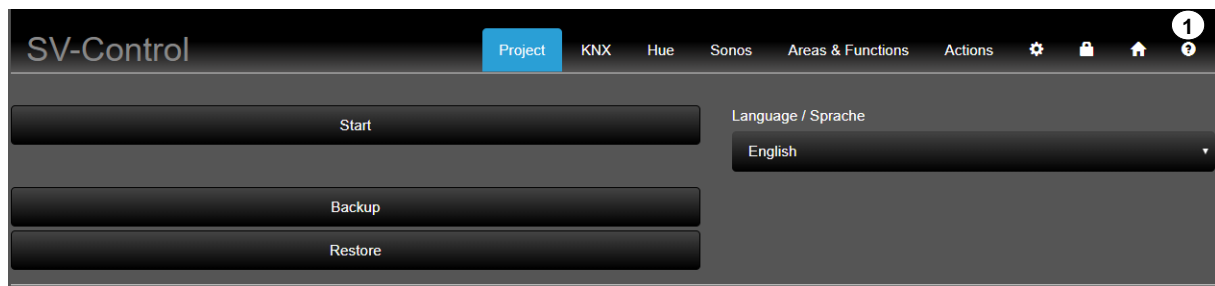


Figure 6: Start page of SV-Control

The product documentation can be opened using the "📄" (1) button.

1.8 Warranty

- Warranty is offered according to the statutory provisions via specialist dealers.



- The CE symbol is a free trade symbol, intended solely for the authorities and does not carry any guarantee of properties.

2 SV-Control

This chapter describes the configuration and commissioning of the Smart Visu Server using SV-Control in detail.

2.1 Project tab

The "Project" tab serves as the homepage of SV-Control. Here, it is possible to set the required language (1), start project design (2), back up the overall project (3) or restore a previously backed up project (4).

After project design has been completed, access to the project design functions can be protected by assigning a password (5).

In addition, the product documentation (6) is stored in SV-Control in German and English.

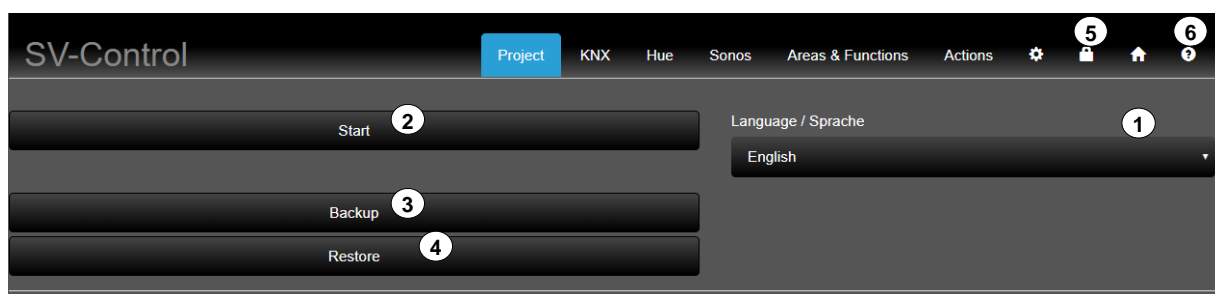


Figure 7: SV-Control, Project tab

2.1.1 Manage language

The desired project design language at SV-Control (1) can be specified in the "Project" tab. It is possible to change over the language settings during commissioning or at a later time. This setting only applies in SV-Control and is identical for each client.

The following languages are available in the selection menu (1):

- German
- Italian
- Estonia
- Ukrainian
- English
- Spanish
- Lithuanian
- Korean
- French
- Portuguese
- Latvian
- Chinese
- Dutch
- Russian
- Polish

2.1.2 Start

Begin project design of the Smart Visu Server using the "Start" button (2).

2.1.3 Backing up a project

The backup of the current project design can be triggered using the "Backup" button (3). This operation can take a moment to complete. The project design can then be downloaded using the "Download" button (3).

2.1.4 Restoring a project

A previous project state can be restored using the "Restore" button (4). This operation can take a couple of minutes to complete.



INFORMATION

The Smart Visu Server can only manage **one** project. If a project is downloaded using the "Restore" button, any existing project will be deleted.

2.1.5 Password protection

After project design has been completed, access to the elementary project design functions can be protected with a password (1).

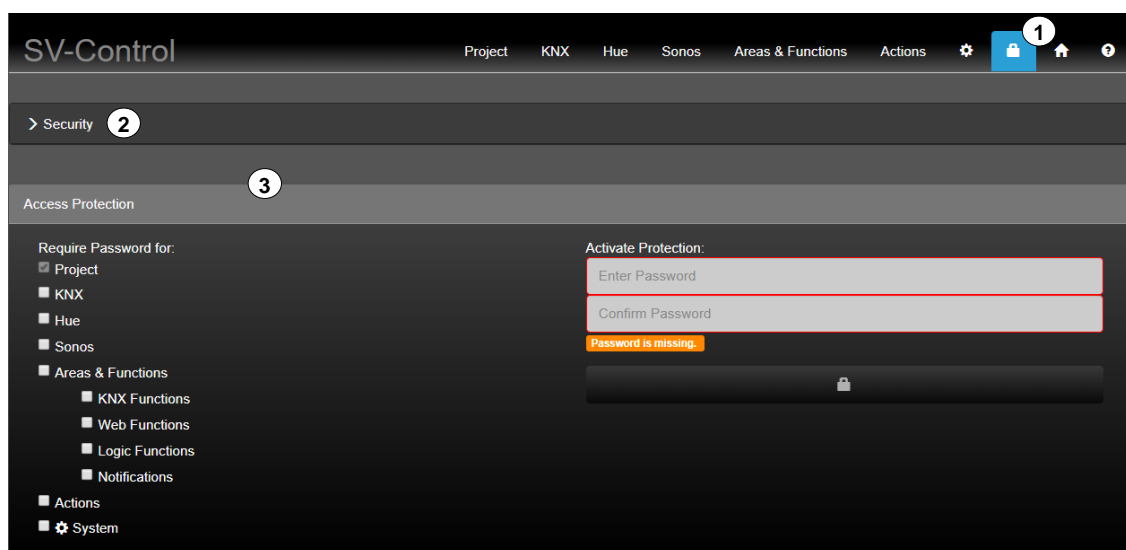


Figure 8: SV-Control, User administration tab

The SV-Control differentiates between complete / restricted access with "Administrator" and "User".

Administrator rights:

- Complete access to all tabs

User rights:

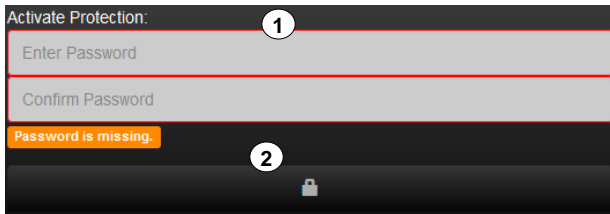
User access rights are determined by the check boxes of the respective tab / category. When a password is set, the user has no access within the "Project" tab.

Additional check boxes:

KNX	- No access within "KNX" tab
Hue	- No access within "Hue" tab
SONOS	- No access within the "SONOS" tab
Areas & Functions	- No access within "Areas & Functions" tab
Exclusively KNX functions	<ul style="list-style-type: none"> - Right to create, change and delete areas - Right to add or delete "Hue functions" from areas - No right to delete "KNX functions" or to edit group addresses of KNX functions. - Only names and icons of KNX functions can be edited and they can be assigned to additional areas or deleted from assigned areas.
Web functions	<ul style="list-style-type: none"> - Right to create, change and delete areas - Right to add or delete "Hue functions" from areas - No right to delete "Web functions" or to edit the URL of Web functions - Only names and icons of web functions can be edited and they can be assigned to additional areas or deleted from assigned areas.
Logic functions	<ul style="list-style-type: none"> - Right to create, change and delete areas - Right to add or delete "Hue functions" from areas - No right to delete or edit "Logic functions" - Only names and icons of logic functions can be edited and they can be assigned to additional areas or deleted from assigned areas
Notifications	<ul style="list-style-type: none"> - Right to create, change and delete areas - Right to add or delete "Hue functions" from areas - No right to delete or edit "Email functions" - Only names and icons of email functions can only be edited and they can be assigned to additional areas or deleted from assigned areas
Actions	- No access within "Actions" tab
System	- No access within "System" tab
Additional tabs	<ul style="list-style-type: none"> - Limited access within "Access protection" tab - Full access within "SV-Home" tab - Full access within "Help" tab

Activating the "User" profile

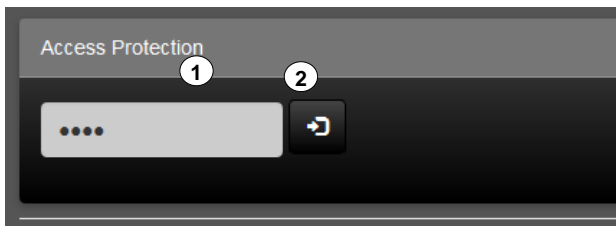
It is possible to specify an Administrator password using the optional assignment of a password in the input fields (1). To activate the "User" profile and apply the password, press the "🔒" button (2).



Administrator active: 🔒
The "User" profile is activated after optional assignment of a password.

Activating the "Administrator" profile

To activate the "Administrator" profile, enter the administrator password in the input field (1) and press the "🔑" button (2).



User active: 🔑
The "Administrator" profile is activated after any set password is entered.

Security:

Encrypted communication can be created in the local network under the "Security" tab (2). On activation (3), a message (4) appears in the browser with further information. The certificate is already stored within the app (iOS / Android).

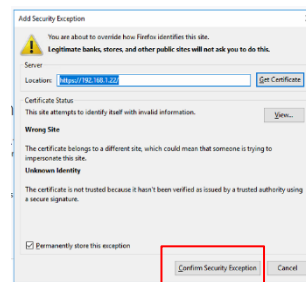
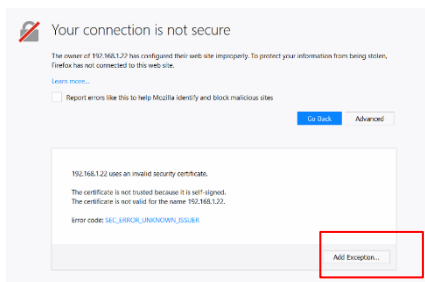
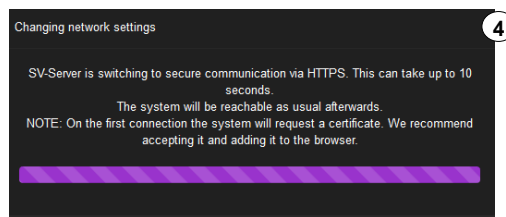


Figure 9: SV-Control – User administration tab – HTTPS configuration

2.1.6 SV-Home

SV Home can be called up using the " ? " button (1) in Figure 10.

2.1.7 Product Documentation

The product documentation can be called up using the " ? " button (2) in Figure 10.

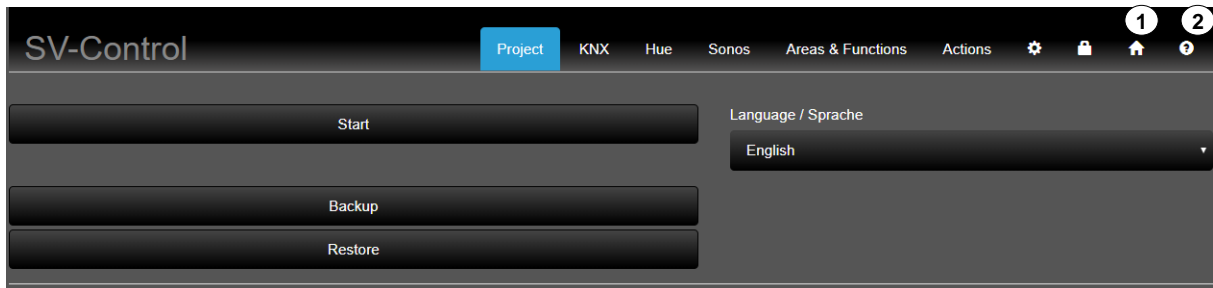


Figure 10: SV-Control Access Protection

2.2 KNX

The "KNX" tab is used to define the KNX-IP Gateway and to import the KNX group addresses using the OPC project file.

2.2.1 Defining the KNX-IP Gateway

To be able to use the KNX functionality of the Smart Visu Server, a connection to the KNX system via a KNX-IP data interface is required, which can be reached from the Smart Visu Server via the IP network.

We recommend using one of the following KNX-IP data interfaces:

- Jung: KNX-IP interface ref. no.: IPS 300 SREG
- Jung: KNX-IP router ref. no.: IPR 300 SREG

The Smart Visu Server must be informed of the current IP address of the KNX-IP data interface. The simplest way to do this is to determine them from the ETS configuration of the device (static IP address active) or from the network router (DHCP active). Enter the determined IP address of the KNX-IP data interface in the "KNX-IP Gateway" field (2).

Immediately on entry, the connection to the KNX-IP data interface is checked. If the connection is successful, the test is visualised by a green tick (✔) or, if it is unsuccessful, by an orange triangle (⚠) at the end of the input line (3).

The button (ⓘ) provides more information about your KNX-IP data interface and the connection (4).

The "KNX" tab can be operated fully for both profiles (Administrator/User).

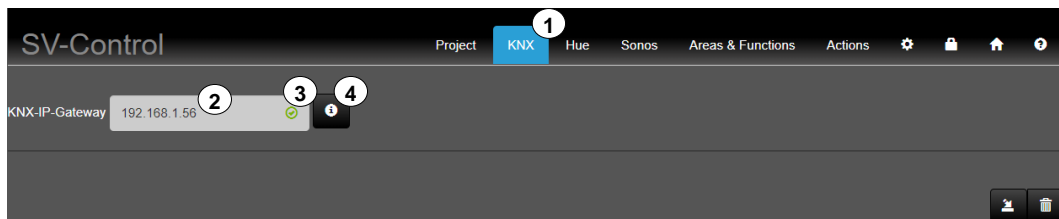


Figure 11: Defining the KNX-IP Gateway

If the connection is faulty, please check the following settings:

- The KNX-IP data interface is switched on and connected to the IP network
- The KNX-IP data interface has a valid IP address assignment for your system
 - o IP address
 - o Subnet mask
 - o Routing Multicast address
- The KNX-IP data interface is set to Port 3671
- The KNX-IP data interface has at least one free physical tunnel connection
- The KNX-IP data interface communicates according to KNXnet-IP tunnelling

2.2.2 Importing the KNX-OPC project file

SV-Control only offers the possibility of importing ETS projects with a 3-level group address structure in the form of OPC project files. OPC project files can be generated from the ETS3 (File → Data Exchange), ETS4 (Tools → Export OPC) and ETS5 (Export project → file type - OPC) and contain all the group addresses, group names, group descriptions and data types created in your project.

The OPC project file helps you to connect the KNX functions of your Smart Visu Server to the appropriate group addresses of the ETS project quickly and simply.

To import the OPC project file, click the "📁" button (1). You will then be asked to select the file and upload it to the Smart Visu Server. After uploading, all the imported group addresses are listed below the Import function, together with the group name, the group description and the data type length.

You can delete the entire OPC project file using the "🗑️" button (2).

You now have the option of actively filtering in the input field (3) (e.g. by name or group addresses) or to display the sorted list by clicking the appropriate column header (group address, status, etc.).

Individual group addresses which are not required can be deleted from the list by clicking the "🗑️" (4) button in the appropriate line.

The screenshot shows the SV-Control interface for a KNX project. At the top, there is a navigation bar with 'Project', 'KNX', 'Hue', 'Sonos', 'Areas & Functions', and 'Actions'. Below this, the 'KNX-IP-Gateway' is shown with the IP address '192.168.1.56' and a status indicator 'ONLINE'. A 'Status' dropdown menu is open, showing 'ONLINE'. To the right of the status, there are two buttons: a folder icon (1) and a trash icon (2). Below the status, there is a table of imported group addresses. The table has columns for 'Group address', 'Status', 'Group name', 'Description', 'Length', and 'Import date'. A search bar (3) is located above the table. The table contains five rows of data, each with a trash icon (4) in the rightmost column.

Group address	Status	Group name	Description	Length	Import date
0/0/1		Zentral.Szene	Szenennummer	1 Byte	10/8/2018, 2:56:02 PM GMT+2
0/1/0		Zentral.Beuchtung	Schalten	1 Bit	10/8/2018, 2:56:02 PM GMT+2
0/1/1		Zentral.Beuchtung	Schalten RM	1 Bit	10/8/2018, 2:56:02 PM GMT+2
0/1/3		Zentral.Beuchtung	Schalten RM	1 Bit	11/22/2018, 7:45:12 AM GMT+1
0/2/0		Zentral.Jalousie	Zentral fahren	1 Bit	10/8/2018, 2:56:02 PM GMT+2

Figure 12: Importing KNX group addresses

2.3 Hue

The "Hue" tab is used for the definition of the [Philips Hue Bridge](#) / [Phoscon Gateways](#) (hereafter gateway) and to import previously integrated Hue devices and other ZigBee Light Link components.

The "Hue" tab can be operated fully for both profiles (Administrator/User).

2.3.1 Defining the Hue-IP Gateway

The Smart Visu Server supports the integration, visualisation and operation of the [Philips Hue Systems](#) / [Phoscon Gateways](#).

To be able to use the hue functionality of the Smart Visu Server, a Philips Hue Bridge is required, which can be reached from the Smart Visu Server via the IP network. In addition, the gateway must have been commissioned. Please refer to the manufacturer's documentation for the appropriate steps.

The IP address of the gateway is automatically detected by the Smart Visu Server and displayed in the "Hue-IP-Gateway" (1) text box.

To couple the bridge with the Smart Visu Server, press the Pairing button of the bridge for authentication (2).

Successful pairing is visualised by a green tick (✔) at the end of the input line (3). A faulty connection or unsuccessful pairing is visualised by an orange triangle (⚠) in the same location.

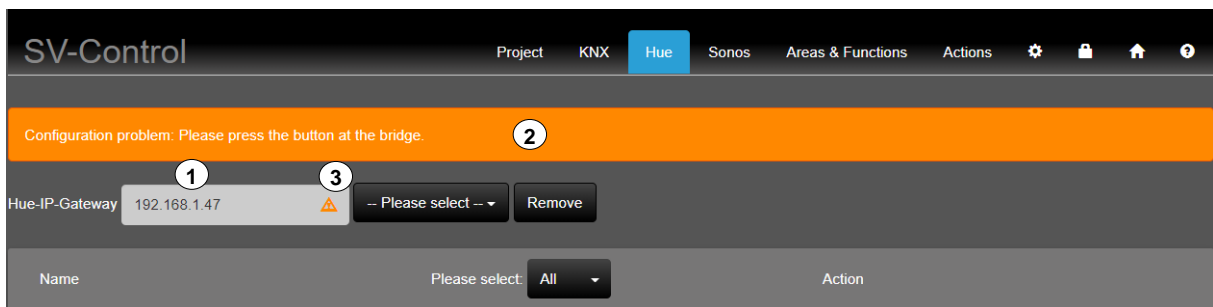


Figure 13: Defining the Philips Hue Bridge

2.3.2 Importing Hue lamps

The lamps and scenes configured in the gateway are then listed below with their name and current status. Only lamps and scenes which are configured in the bridge are listed.

By pressing the “+” button (1), selected lamps and scenes can be added as a hue function. Lamps or scenes that have already been added can be removed again with the same “-” button (2). If you would like to add further lamps that are not listed, they must first be configured in the gateway.

In the dropdown menu, all the lamps and scenes can be displayed with “All” or you can choose between “Lights” and “Scenes” (3).

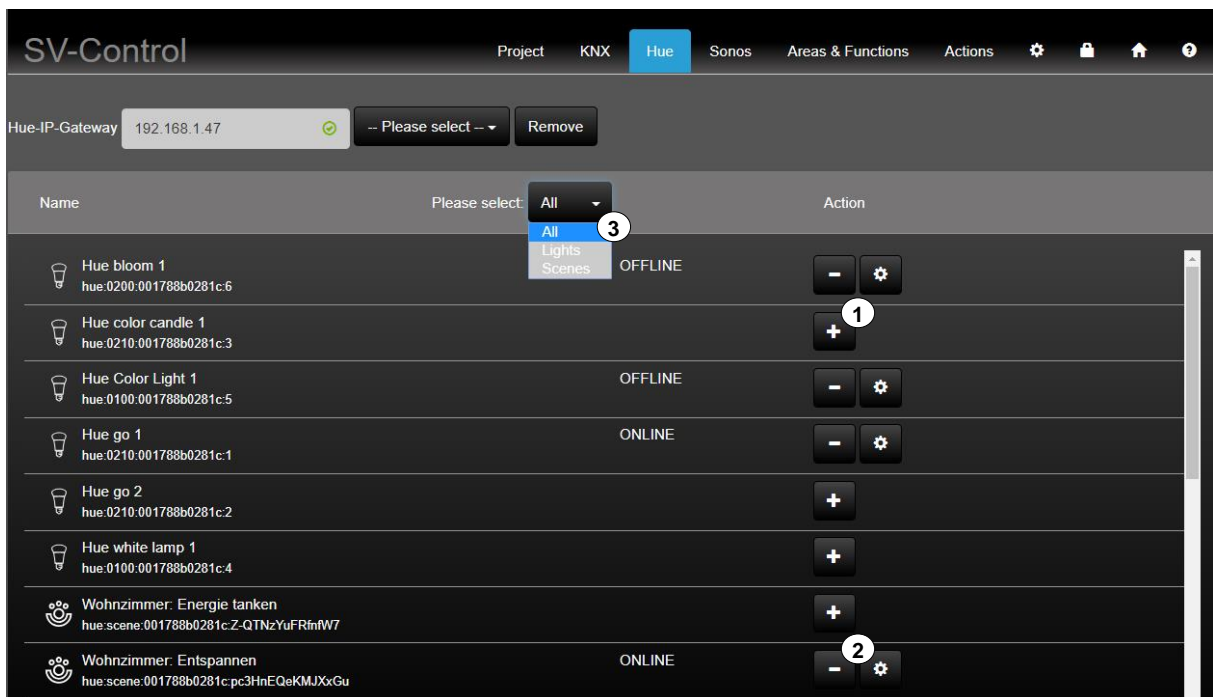


















Figure 14: Integrating Philips Hue lamps

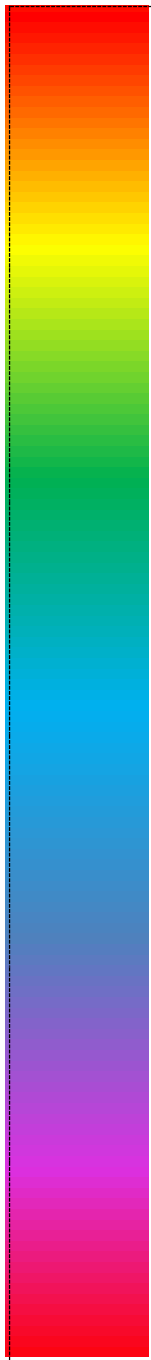
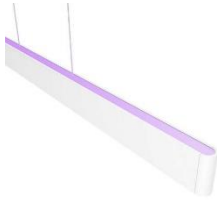





2.3.2.1 ZigBee – tested devices



Group	Figure	Name	Compatibility
WHITE		Hue White WW	✓
		Truar	
TUNEABLE WHITE		Hue GU10 TW Adore	✓
		Hue White Ambience E14 TW	✓
		Hue White Ambience E27 TW	✓
		Hue White Ambience Flexstrip TW	✓
		Hue White Ambience Being TW	✓
		Hue White Ambience Flexstrip TW	✓
		Hue White Ambience Cher	✓
		Hue White Ambience Wellness TW	✓

TUNEABLE WHITE		Hue White Ambience Wellness TW	✓
		Hue White Ambience Flexstrip TW	✓
		Hue White Ambience Spot Pillar TW	✓
		Hue White Ambience – Spot Runner GU10 TW	✓
		Hue Beyond TW	✓
		Adore bathroom mirror	✓
		Adore mirror light	✓
		Hue Phoenix TW	✓

RGBW		Hue E27 RGBW	✓
		Hue GU10 RGBW	✓
		Hue White and Colour Ambience RGBW	✓
		Hue LightStrip RGBW	✓
RGBW		Hue LightStrip Plus RGBW	✓
		Hue Go RGBW	✓
		Hue Play	✓
		Hue Outdoor Stripe	✓
		Hue Signe	✓

		<p>Hue Ensis</p>	<p>✓</p>
	<p>Hue Calla</p>	<p>✓</p>	
	<p>Turaco</p>	<p>✓</p>	
	<p>Lily</p>	<p>✓</p>	
	<p>Hue Iris RGBW</p>	<p>(✓) Attention! Must be Friends of Hue certified!</p>	
	<p>Hue Bloom RGBW</p>	<p>(✓) Attention! Must be Friends of Hue certified!</p>	


2.4 SONOS



The “SONOS” tab is used for the native import of SONOS speakers in the Smart Visu Server. They must be configured beforehand in a SONOS account.

2.4.1 Inserting SONOS devices

The Smart Visu Server supports the integration, visualisation and operation of the SONOS system.

To be able to use the SONOS functionality of the Smart Visu Server, it is first necessary to set up the SONOS speakers which can be carried out by the Smart Visu Server via the IP network. The SONOS speakers must be fully set up beforehand in a SONOS account. This includes the storing of playlists, radio stations and local music so that they can be selected in the Smart Visu Server. Parallel operation via UPnP is not possible.

The SONOS speakers are automatically detected (1) and displayed directly (2) by the Smart Visu Server by pressing the “” button.

By pressing the “” button (3), selected speakers can be added as a SONOS function. Speakers that have already been added can be removed again with the same “” button (4). If you would like to add further speakers which are not listed, they must first be configured in the identical SONOS account.

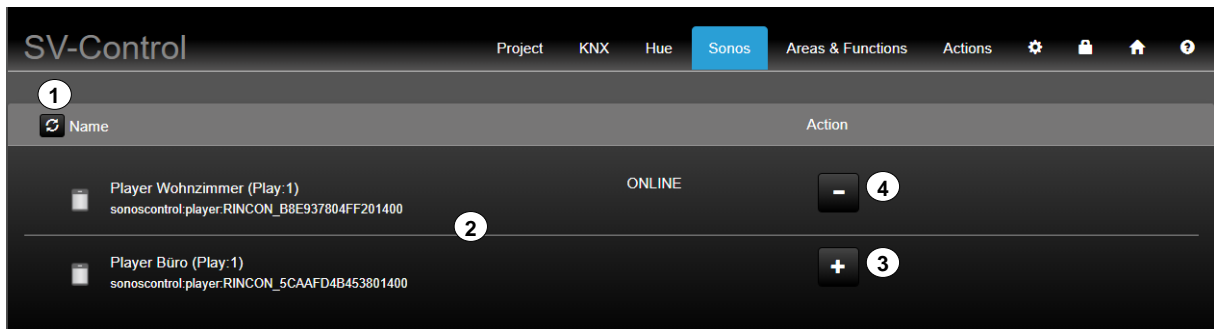


Figure 15: Integrating the SONOS speakers

2.4.1.1 SONOS – supported devices

Figure	Name	Compatible
	SONOS One	✓*
	SONOS Play:1	✓*
	SONOS Play:3	✓
	SONOS Play:5	✓*
	SONOS BEAM	✓
	SONOS Playbar	✓*

	<p>SONOS Amp</p>	<p>✓</p>
	<p>SONOS Outdoor-Speaker</p>	<p>✓</p>
	<p>SONOS In-Wall Speaker</p>	<p>✓</p>

* tested speakers between SONOS API and Smart Visu Server

Date: 04/2019

2.5 Area & Functions

An area is a group of functions and actions for visualisation in SV-Home under an individual area name. To improve recognition, an icon can be added to each of the up to 24 areas.

Areas allow you to group a maximum of 240 functions and 250 actions as you require, e.g. spatially and/or by unit. Functions can be assigned to multiple areas simultaneously.

The access rights within the “Area & Functions” tab are limited for the “User” profile. Overview of the access rights with activated check boxes:

Access	User					Admin
	Areas & Functions	KNX	Web	Logic	Notification	
Create new areas	-				✓	
Edit the names of the areas						
Edit the icons of the areas						
Edit the sequence of functions within the areas						
Delete existing areas						
Create new KNX functions	-	-	✓	✓	✓	✓
Create new web functions	-	✓	-	✓	✓	✓
Create new logic function	-	✓	✓	-	✓	✓
Create new notification	-	✓	✓	✓	-	✓
Edit the names of the KNX functions	-				✓	
Edit the names of the web functions						
Edit the names of the logic functions						
Edit the names of the notifications						
Edit the icons of the KNX functions	-				✓	
Edit the icons of the web functions						
Edit the icons of the logic functions						
Edit the icons of the notifications						
Edit the group address of the KNX functions	-	-	✓	✓	✓	✓
Edit the URL of the web functions		✓	-	✓	✓	✓
Edit the update rate of the web functions		✓	-	✓	✓	✓
Edit the resolution of the web functions		✓	-	✓	✓	✓
Edit the inputs of the logic functions		✓	✓	-	✓	✓
Edit limit values (logic)		✓	✓	-	✓	✓
Edit email recipients and content		✓	✓	✓	-	✓
Assign new existing KNX functions to new areas		-				✓
Remove existing KNX functions from new areas	-				✓	
Permanently delete existing KNX functions	-	-	✓	✓	✓	✓
Permanently delete existing web KNX functions		✓	-	✓	✓	✓
Permanently delete existing logic functions		✓	✓	-	✓	✓
Permanently delete existing notifications		✓	✓	✓	-	✓

Table 1: Access rights of Administrator and User

2.5.1 Creating a new area

The maximum of 24 areas must be provided individual names. In addition icons from the SV-Server library or additional descriptions can be added. The "User" and the "Administrator" have identical access rights within the "Areas" column.

To create a new area, enter the name of the new area in the "Areas" column (1) and then press the "+" button (2). The new area is added to the area list with its name and is selected automatically.

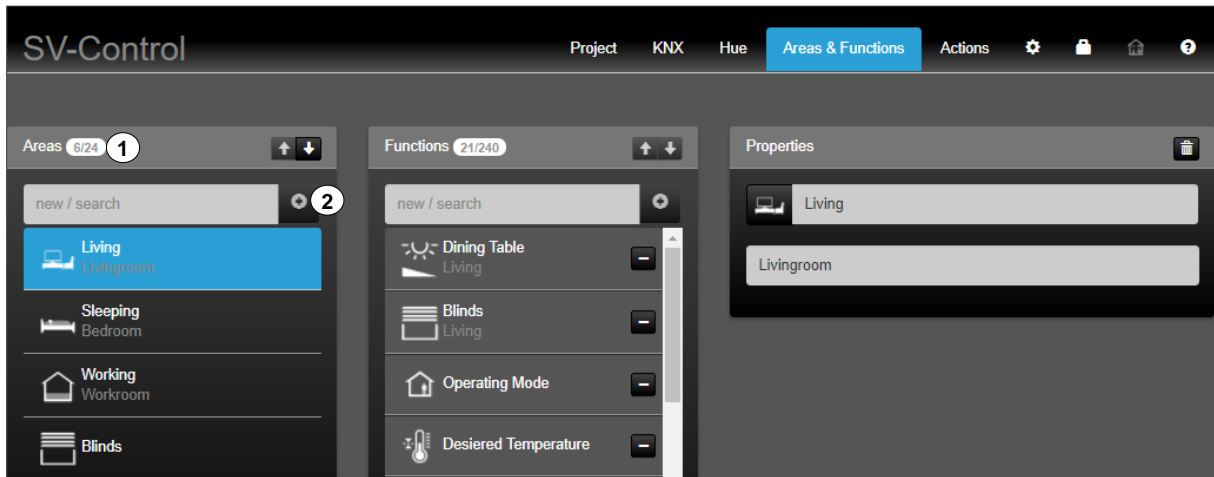


Figure 16: Creating new areas

The arrow buttons "↑ ↓" (3) allow you to change the order of an area, after selecting it, and thus to move the position in SV-Home. The top area in the SV-Control (from top to bottom) is displayed as the first area in SV-Home (from left to right).

In the "Properties" column, it is possible to assign an icon to the selected area by pressing the currently selected icon "🏠" (4), edit the name of the area (5) and, beneath that, add a description (6).

The changes are saved automatically and briefly displayed by a green display (7) "Save successful". The most recently saved properties can be restored with the "🔄" button (8).

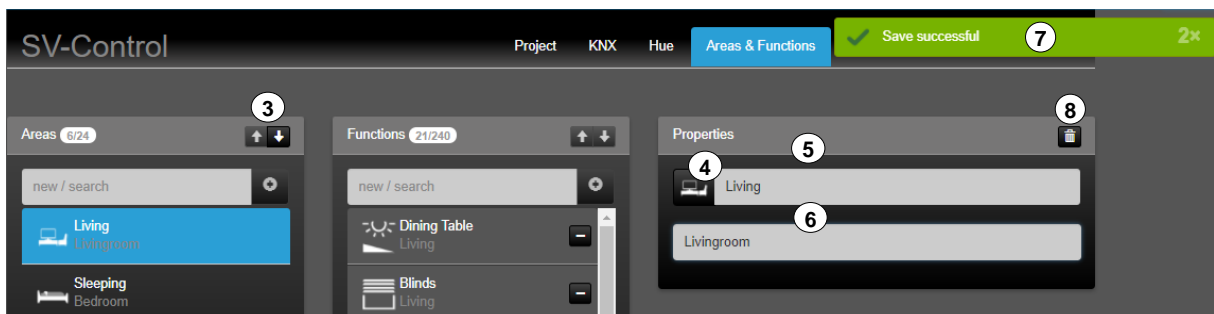


Figure 17: Individualisation of created areas

2.5.2 Editing or deleting areas

Select an area to edit or delete it. The "Areas" column lists all the existing areas.

In the "Properties" column, it is possible to assign an alternative icon to the selected area by pressing the currently selected icon "🏠" (3), edit the name of the area (4) and, beneath that, add a description (5).

The changes are saved automatically and briefly displayed by a green display "Save successful".

To fully delete the selected area, press the "🗑️" button (7).

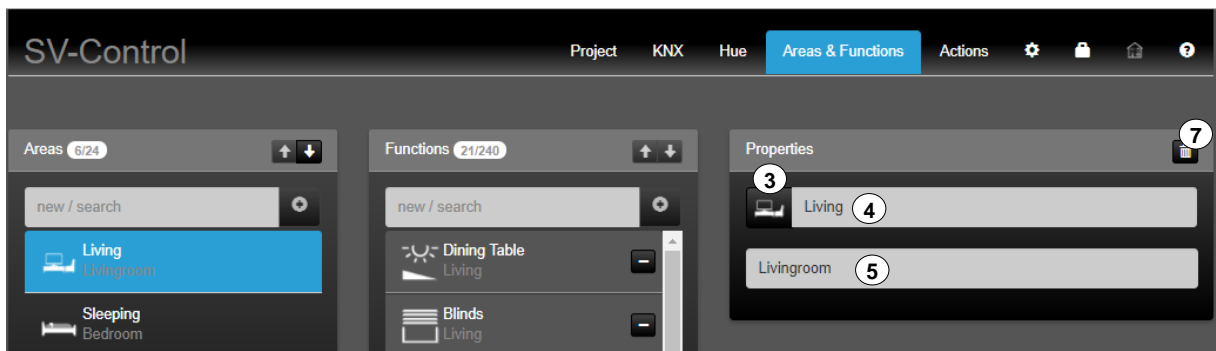


Figure 18: Editing or deleting areas

The area has favourites within the symbol library (5). Additional icons are available via the "▼" button.

Area	Selection of the icon library in SV-Control	Operating and display element in SV-Home
Area		

Table 1: individualisation of areas

2.5.3 Creating a new function

A function corresponds to, for example, a KNX function, which possibly comprises multiple group addresses. Up to 240 functions can be given individual names, icons from the SV-Server library or additional descriptions. Each function can be assigned to one or more areas or to none.

Access as Administrator

To create a new function, enter the name of the new function in the “Functions” column (1) and then press the “+” button (2).

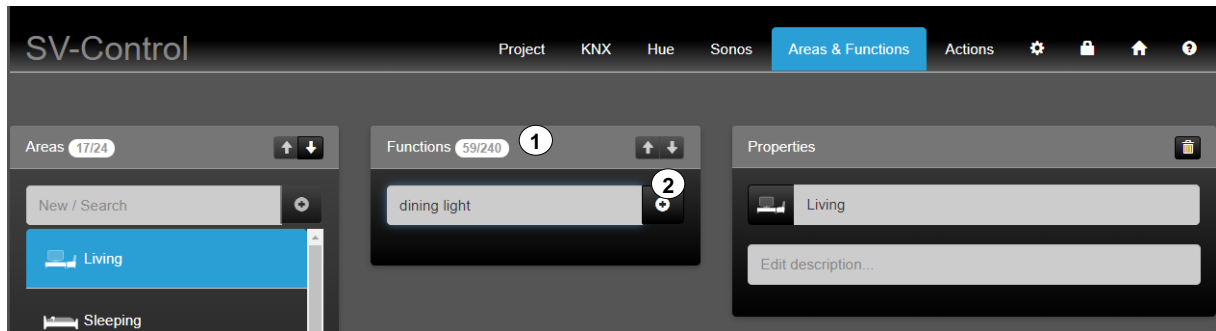


Figure 19: Create new function

A suitable function must be selected in the pop-up window from the available types (3).

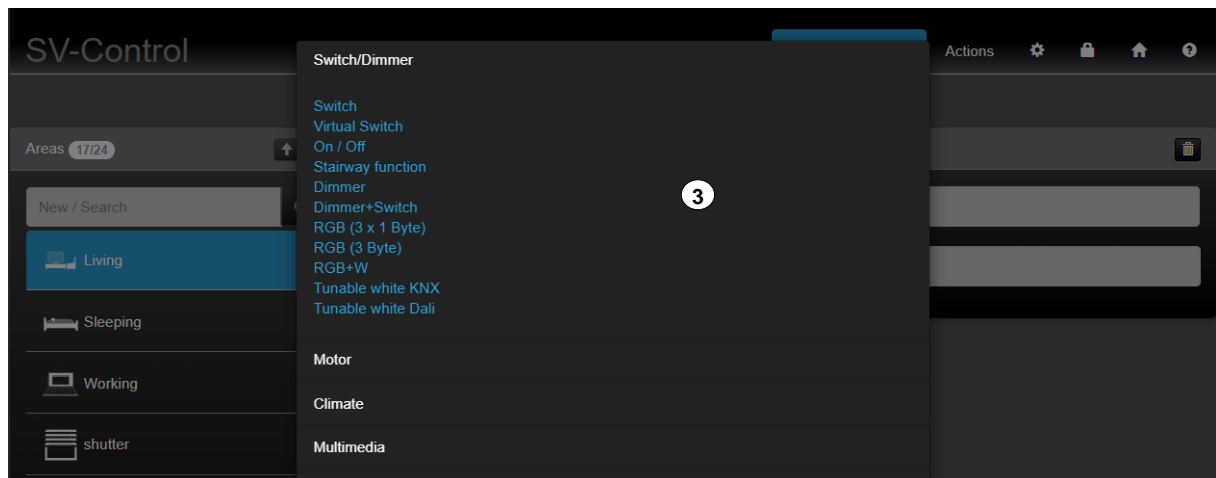


Figure 20: Selection of the appropriate function from the function type

The new function is added in the list of functions with its name, automatically selected and assigned to a selected area if required (4).

A symbol can be assigned to the selected function by pressing the current symbol (5). The name of the function can be edited (6) and a description (7) can be added.

The changes are stored automatically and represented by a green display.

In addition, the button “+” (8) indicates whether the entries of the group addresses are stored.

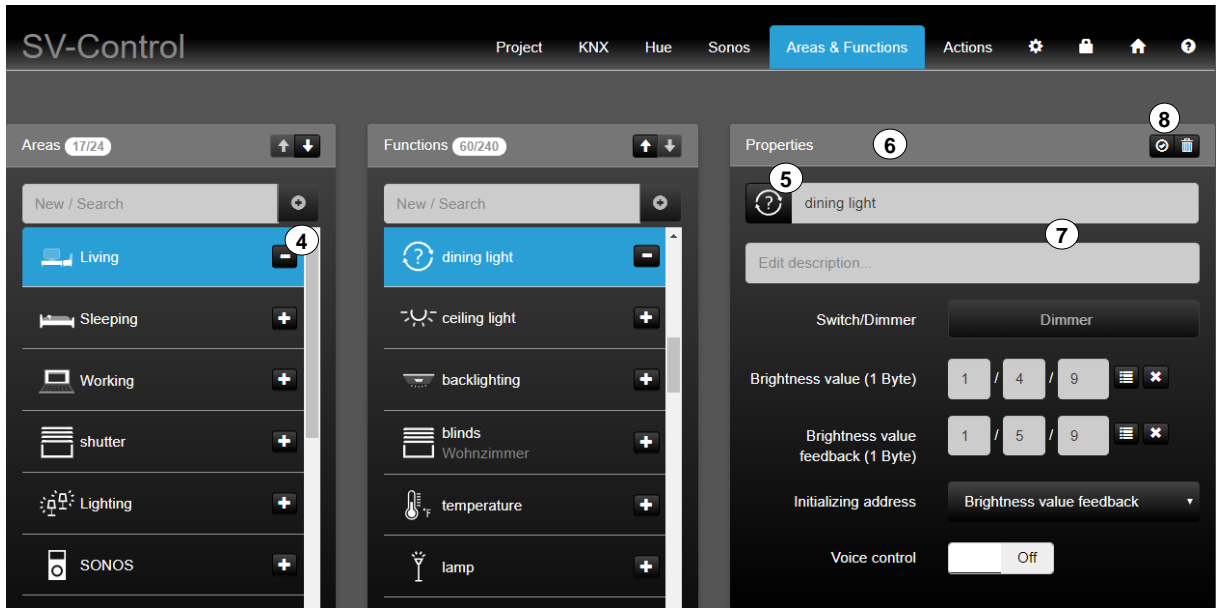


Figure 21: Structure of the "Areas and Functions" tab

Access as User

You require Administrator rights to be able to create new KNX functions (see chapter 2.1.5).

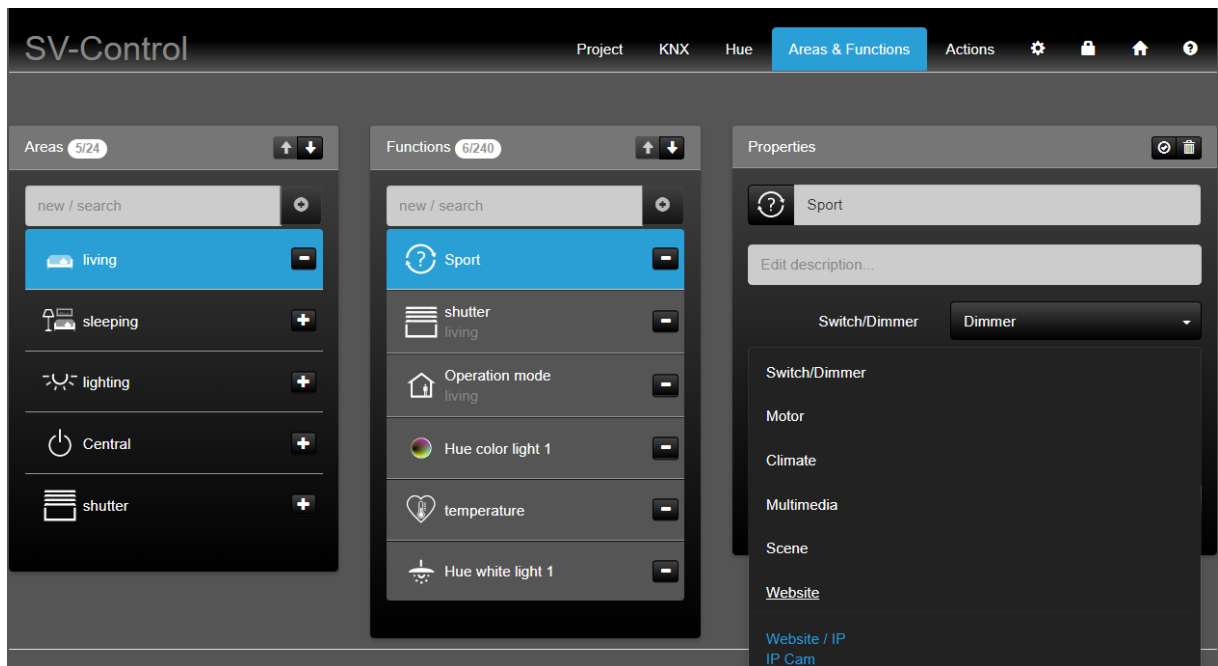


Figure 22: Access rights of the user with access to web functions

2.5.4 Configuring KNX functions

Successful commissioning of the KNX system and definition of the KNX-IP Gateway in SV-Control are required to be able to use KNX functions.

Access as Administrator or User

The "User" and the "Administrator" can have different access rights to KNX functions within the "Functions" column. The different access rights can be taken from Table 1: Access rights of Administrator and User

Each KNX function can be described by a specific function type and summarises suitable ETS group addresses.

The following function types are available to the Administrator:

Function type	KNX function	KNX group addresses				Depiction in SV-Control
		Write addresses	Size DPT	Read addresses	Size [DPT]	
Switch / Dimmer	Switch	Switch (1 Bit)	1 Bit 1.001	Switch feedback	1 Bit 1.001	
	On / Off	On / Off (1 Bit)	1 Bit 1.001	---	---	
	Stairway function	Switch [0 or 1] 1 = ON delay 0 = OFF delay	1 Bit 1.001	---	---	
	Dimmer	Brightness value	8 Bit 5.001	Brightness value feedback	8 Bit 5.001	
	Dimmer/Switch	Brightness value	Brightness value	8 Bit 5.001	Brightness value feedback	8 Bit 5.001
Switch						

	RGB (3 x 1 Byte)	Send value red	8 Bit 5.001	Value red feedback	8 Bit 5.001		
		Send value green	8 Bit 5.001	Value green feedback	8 Bit 5.001		
		Send value blue	8 Bit 5.001	Value blue feedback	8 Bit 5.001		
		Switch	1 Bit 1.001	Switch feedback	1 Bit 1.001		
	RGB (3 Byte)	Send value RGB	24 Bit 232.600	Value RGB feedback	24 Bit 232.600		
		Switch	1 Bit 1.001	Switch feedback	1 Bit 1.001		
	RGB+W KNX	Send value RGB	24 Bit 232.600	Value RGB feedback	24 Bit 232.600		
		Send value white	8 Bit 5.001	Value white feedback	8 Bit 5.001		
		Switch	1 Bit 1.001	Switch feedback	1 Bit 1.001		

	Tunable white KNX	Send value	8 Bit 5.001	Value feedback	8 Bit 5.001	
		Absolute color temperature	16 Bit 7.600	Absolute color temperature feedback	16 Bit 7.600	
		Switch	1 Bit 1.001	Switch feedback	1 Bit 1.001	
	Tunable white Dali	Send value	8 Bit 5.001	Value feedback	8 Bit 5.001	
		Absolute color temperature	16 Bit 7.600	Absolute color temperature feedback	16 Bit 7.600	
		Value range	0 - 65535	---	---	
Switch		1 Bit 1.001	Switch feedback	1 Bit 1.001		
Motor	UP / DOWN / STOP	Long time	1 Bit 1.008	---	---	
		Short time	1 Bit 1.008	---	---	
	UP / DOWN / STOP (State)	Long time	1 Bit 1.008	---	---	
		Short time	1 Bit 1.008	---	---	
		---	---	Curtain position feedback	8 Bit 5.001	
	Rollershutter/ Awning	Curtain position	8 Bit 5.001	Curtain position feedback	8 Bit 5.001	









	Venetian Blinds (Slider)	Curtain position	8 Bit 5.001	Curtain position feedback	8 Bit 5.001	
		Slat position	8 Bit 5.001	Slat position feedback	8 Bit 5.001	
	Venetian Blinds (Button)	Long time	1 Bit 1.008	---	---	
		Short time	1 Bit 1.008	---	---	
		Curtain position	8 Bit 5.001	Curtain position feedback	8 Bit 5.001	
		Slat position	8 Bit 5.001	Slat position feedback	8 Bit 5.001	

Climate	Ventilate	Fan Mode	1 Bit 1.001	Fan level feedback	8 Bit 5.010	
	Operation mode	Switch operation mode	8 Bit 20.102	Switch operation mode feedback	8 Bit 20.102	
	HVAC Control Mode	Switch operation mode	8 Bit 20.102	Switch operation mode feedback	8 Bit 20.102	
	Base Setpoint	Setpoint	16 Bit 9.001	Display temperature	16 Bit 9.001	
---		---	Actual temperature	16 Bit 9.001		

	Setpoint shift	Setpoint shift	8 Bit 6.010	Setpoint shift feedback	8 Bit 6.010	<div style="background-color: #333; color: #eee; padding: 5px;"> <p>Climate Setpoint Shift</p> <p>Setpoint shift (1 Byte) <input type="text"/> / <input type="text"/> / <input type="text"/> <input type="button" value="⋮"/> <input type="button" value="✕"/></p> <p>Setpoint shift feedback (1 Byte) <input type="text"/> / <input type="text"/> / <input type="text"/> <input type="button" value="⋮"/> <input type="button" value="✕"/></p> <p>Initializing address <input type="text" value="-- no initializing address --"/></p> <p>Display temperature (2 Byte) <input type="text"/> / <input type="text"/> / <input type="text"/> <input type="button" value="⋮"/> <input type="button" value="✕"/></p> <p>Initializing address <input type="text" value="-- no initializing address --"/></p> <p>Actual Temperature (2 Byte) <input type="text"/> / <input type="text"/> / <input type="text"/> <input type="button" value="⋮"/> <input type="button" value="✕"/></p> <p>Initializing address <input type="text" value="-- no initializing address --"/></p> </div>
		---	---	Display temperature	16 Bit 9.001	
		---	---	Actual temperature	16 Bit 9.001	
	HVAC Group	---	---	Display temperature	16 Bit 9.001	<div style="background-color: #333; color: #eee; padding: 5px;"> <p>Climate HVAC Group</p> <p>Display temperature (2 Byte) <input type="text"/> / <input type="text"/> / <input type="text"/> <input type="button" value="⋮"/> <input type="button" value="✕"/></p> <p>Initializing address <input type="text" value="-- no initializing address --"/></p> <p>Actual Temperature (2 Byte) <input type="text"/> / <input type="text"/> / <input type="text"/> <input type="button" value="⋮"/> <input type="button" value="✕"/></p> <p>Initializing address <input type="text" value="-- no initializing address --"/></p> <p>Setpoint shift (1 Byte) <input type="text"/> / <input type="text"/> / <input type="text"/> <input type="button" value="⋮"/> <input type="button" value="✕"/></p> <p>Setpoint shift feedback (1 Byte) <input type="text"/> / <input type="text"/> / <input type="text"/> <input type="button" value="⋮"/> <input type="button" value="✕"/></p> <p>Initializing address <input type="text" value="-- no initializing address --"/></p> <p>Switch operation mode (1 Byte) <input type="text"/> / <input type="text"/> / <input type="text"/> <input type="button" value="⋮"/> <input type="button" value="✕"/></p> <p>Switch operation mode feedback (1 Byte) <input type="text"/> / <input type="text"/> / <input type="text"/> <input type="button" value="⋮"/> <input type="button" value="✕"/></p> <p>Initializing address <input type="text" value="-- no initializing address --"/></p> <p>OP Mode 1 <input type="text" value="Comfort"/> <input type="text" value="1"/></p> <p>OP Mode 2 <input type="text" value="Standby"/> <input type="text" value="2"/></p> </div>
		---	---	Actual temperature	16 Bit 9.001	
		Setpoint shift	8 Bit 6.010	Setpoint shift feedback	8 Bit 6.010	
		Switch operation mode	8 Bit 5.010	Switch operation mode feedback	8 Bit 5.010	

Multi-media	Playlist Various	Volume	8 Bit 5.001	Volume feedback	8 Bit 5.001	
		Text 1/2/3	14 Byte 16.001	---	---	
		Play/Pause	1 Bit 1.010	Play/Pause feedback	1 Bit 1.010	
		Playlist	1 Bit 1.007	---	---	
		Track	1 Bit 1.007	---	---	
		Playlist selection	8 Bit 5.010	---	---	
		Multi-media	Playlist Mode	Volume	8 Bit 5.001	
Text 1/2/3	14 Byte 16.001			---	---	
Play/Pause	1 Bit 1.010			Play/Pause feedback	1 Bit 1.010	
Track	1 Bit 1.007			---	---	
Playlist	1 Bit 1.007			---	---	
Repeat	1 Bit			Repeat feedback	1 Bit	
Shuffle	1 Bit 1.003			Shuffle feedback	1 Bit 1.003	
Playlist selection	8 Bit 5.010			---	---	

Multi-media	Playlist Mode	Volume	8 Bit 5.001	Volume feedback	8 Bit 5.001	
		Text 1/2/3	14 Byte 16.001			
		Play/Pause	1 Bit 1.010	Play/Pause feedback	1 Bit 1.010	
		Track	1 Bit 1.007	---	---	
		Playlist	1 Bit 1.007	---	---	
		Repeat	1 Bit 1.003	Repeat feedback	1 Bit 1.003	
		Shuffle	1 Bit 1.003	Shuffle feedback	1 Bit 1.003	
		Playlist selection	8 Bit 5.010			
		Connect	1 Bit 1.017	Connect feedback	1 Bit 1.017	
Scene	Activate scene	Scene group address	8 Bit 18.001	---	---	
	Activate & learn scene	Scene group address	8 Bit 18.001	---	---	
Value / State	Display 1 Bit (boolean)	----	---	Status	1 Bit e.g. 1.001	

Display 1 Byte (0...100%)	----	---	Value	8 Bit e.g. 5.010	
Display 1 Byte (0...255%)	----	---	Value	8 Bit e.g. 5.004	
Display 1 Byte (0...360°)	----	---	Value	8 Bit e.g. 14.007	
Display 2 Byte (float)	----	---	Value	16 Bit e.g. 9.001	
Display 2 Byte (lux)	----	---	Value	16 Bit e.g. 7.013	
Display 2 Byte (time)	----	---	Value	16 Bit e.g. 7.005	
Display 4 Byte (GPS)	----	---	Value	32 Bit e.g. 14.007	
Display 4 Byte value (float)	----	---	Value	32 Bit e.g. 14.056	

	Display 4 Byte value (unsigned integer)	----	---	Value	32 Bit e.g. 12.001	
	Display 4 Byte value (signed integer)	----	---	Value	32 Bit e.g. 13.013	
	Display 14 Byte ASCII	----	---	Value	112 Bit e.g. 16.001	
Weather	Weather Universal	----	---	Temperature	16 Bit 9.001	
		---	---	Rainfall	1 Bit 1.011	
		----	---	Wind speed	16 Bit 9.005	
		----	---	Wind alert 1	1 Bit 1.005	
		----	---	Wind alert 2	1 Bit 1.005	
		---	---	Pressure	16 Bit 9.006	
		----	---	Humidity	16 Bit 9.007	
		----	---	Brightness	16 Bit 7.013	
	----	---	Twilight	16 Bit 7.013		
	Weather Home	Weather Home	----	---	Temperature	16 Bit 9.001
---			---	Rainfall	1 Bit 1.011	
----			---	Wind speed	16 Bit 9.005	
----			---	Wind alert 1	1 Bit 1.005	
----			---	Wind alert 2	1 Bit 1.005	
----			---	Brightness	16 Bit 7.013	
----			---	Twilight	16 Bit 7.013	

	Threshold	---	---	Operation mode Base setpoint Setpoint adjustment Function group HVAC Display 1 Byte Display 2 Byte Display 4 Byte	5.010 9.001 9.001 9.001 5.001 9.001 14.056	
Value transmitter	Send 1 Byte (0...255%)	Value	8 Bit 5.004	----	---	
		Value	0 -255	----	---	
		Range of values	0 - 255	----	---	
	Send 2 Byte (lux)	Value	16 Bit 7.013	----	---	
		Value send	0 - 99999	----	---	
		Range of values	0 - 99999	----	---	
	Value transmitter 2 Byte (time)	Value	2 Byte 7.005	---	---	
		Value send	99999 - 99999	---	---	
		Range of values	99999 - 99999	---	---	
	Date / Time (2 x 3 Byte)	Time	3 Byte 10.001	---	---	
		Date	3 Byte 11.001	---	---	
	Date + time (1 x 8 Byte)	Date and time	8 Byte 19.001	---	---	

2.5.4.1 Switch / Dimmer

If required, the function type "Switch / Dimmer" can be depicted by four KNX functions.

Switch:

The "Switch" function (1) is the standard KNX function for the simple switching on and off of switch actuators. In the "Switch" function, a group address can be defined for writing "Switch" status changes (2) as can a group address for reading "Switch feedback" feedback (3).

In addition, the current status of a group address can be polled by defining an initialisation address (4) on starting the system.

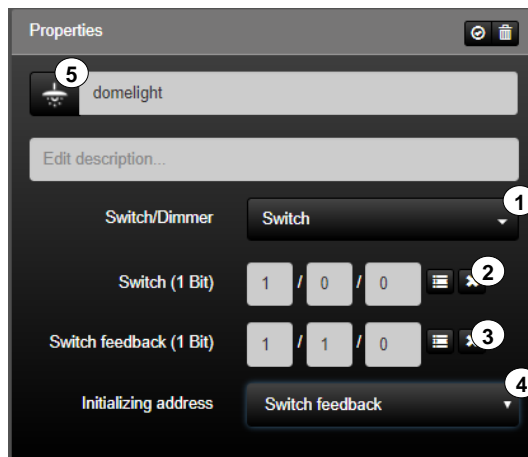


Figure 23: Parameters of the "Switch" function

The function has favourites within the symbol library (5). Additional icons are available via the "▼" button.

KNX function	Selection of the icon library in SV-Control	Operating and display element in SV-Home
Switch		

Table 2: Display of the "Switch" function

On / Off:

The "On / Off" (1) function is stateless (without feedback) for targeted triggering of a switching signal (e.g. only switch-off). A group address "On / Off" (2) can be configured for writing the value specified in the input field "Value" (3).

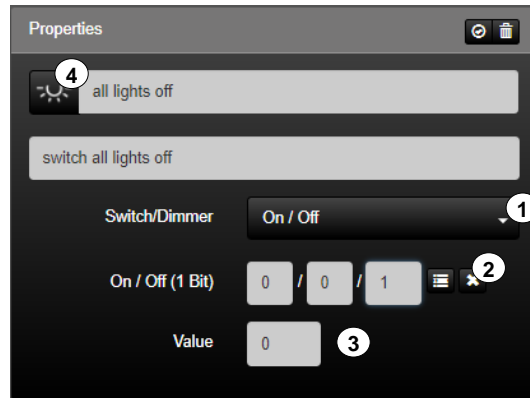


Figure 24: Parameters of the "On / Off" function

The function has favourites within the symbol library (4). Additional icons are available via the "▼" button.

KNX function	Selection of the icon library in SV-Control	Operating and display element in SV-Home
On / Off		

Table 3: Display of the "On / Off" function

Stairway function:

The “Stairway function” (1) can be used for switching on/off loads with a time delay. A restart of the stairway function fully retriggers the stairway time. A group address “On / Off” (2) can be configured to write the value defined in the “Value” input field (ON delay = 0, OFF delay = 1). Once the period has elapsed, the value entered under (3) is inverted and sent. The following staircase times (4) are available:

- | | | |
|------------|-------------|--------------|
| • 1 second | • 5 seconds | • 30 seconds |
| • 1 minute | • 5 minutes | • 30 minutes |
| • 1 hour | • 2 hours | • 3 hours |
| | | • 4 hours |

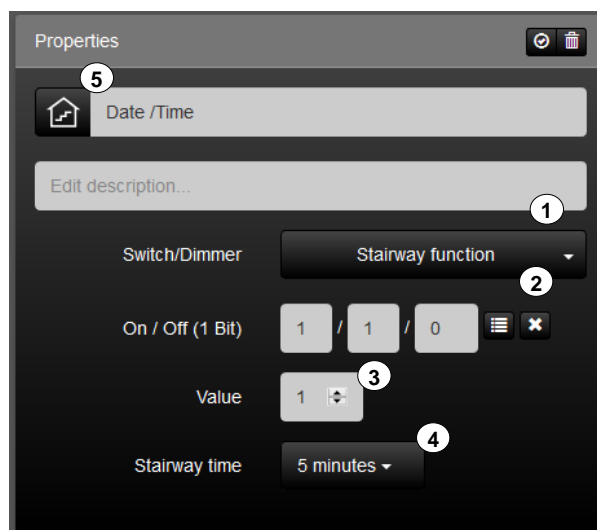


Figure 25: Parameters of the function “Stairway function”

The function has favourites within the symbol library (5). Further icons are available via the “▼” button.


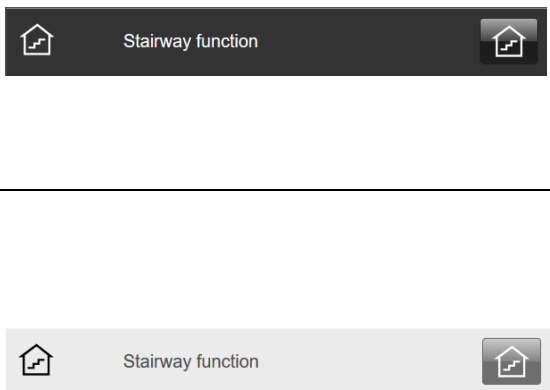
KNX function	Selection of the symbol library in SV-Control	Operating and display element in SV-Home
Stairway function		

Table 4: Display of the “Stairway function”

Dimmer/Switch:

The "Dimmer + Switch" function (1) is used for the simple dimming of dimmer actuators. A "Switching" (2) and / or "Brightness value" (4) group address can be configured for switching or writing a new brightness value. In the same way, it is possible to configure the group addresses "Switch feedback" (3) and "Brightness value feedback" (5) in order to read the feedback.

In addition, the current status of a selectable group address can be polled by defining an initialisation address (6) on starting the system.

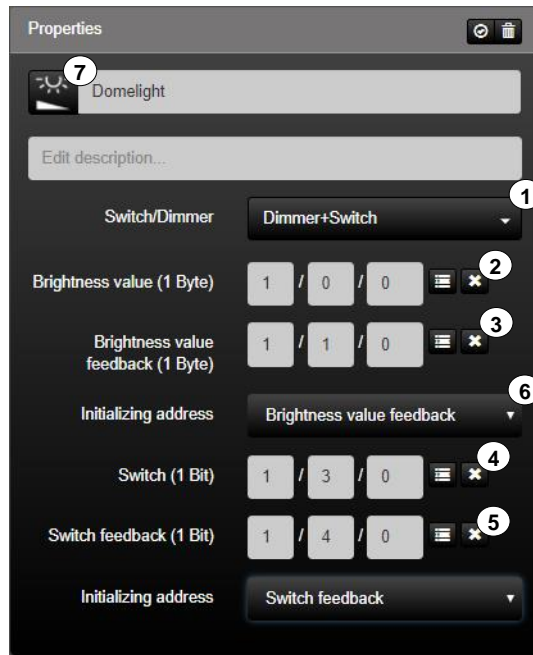


Figure 26: Parameters of the "Dimmer/Switch" function

The function has favourites within the symbol library (7). Additional icons are available via the "▼" button.

KNX function	Selection of the icon library in SV-Control	Operating and display element in SV-Home
Dimmer + Switch		

Table 5: Display of the "Dimmer" function

Dimmer:

The "Dimmer" function (1) is used for the simple dimming of dimmer actuators. A "Brightness value" (2) group address can be configured for switching or writing a new brightness value. In the same way, it is possible to configure the group addresses "Brightness value feedback" (3) in order to read the feedback.

In addition, the current status of a selectable group address can be polled by defining an initialisation address (5) on starting the system.

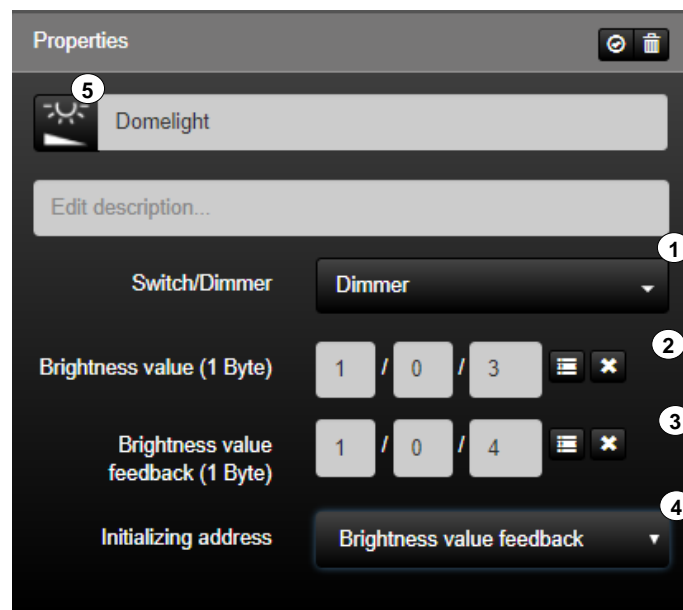


Figure 27: Parameters of the "Dimmer" function

The function has favourites within the symbol library (5). Additional icons are available via the "▼" button.

KNX function	Selection of the icon library in SV-Control	Operating and display element in SV-Home
Dimmer		

Table 6: Display of the "Dimmer" function

RGB (3 x 1 Byte):

The function “RGB (3 x 1 Byte)” (1) is the KNX function for controlling RGB dimming actuators. With the group address e.g. “Send value red” (2), the current brightness value of the red colour channel can be written on the bus. The group address “Value red feedback” (3) can be defined to read the current brightness of the red colour channel.

In addition, it is possible to query the current status of the selected group address of the colour channel by declaring one of the group addresses “Initializing address red” (4) at system start. The same applies to the green (5 - 7) and blue (8 - 10) colour channels. The “Switch” group address (11) can be defined for central switching of the function. The switching state of the function can also be read via the group address “Switch feedback” (12).

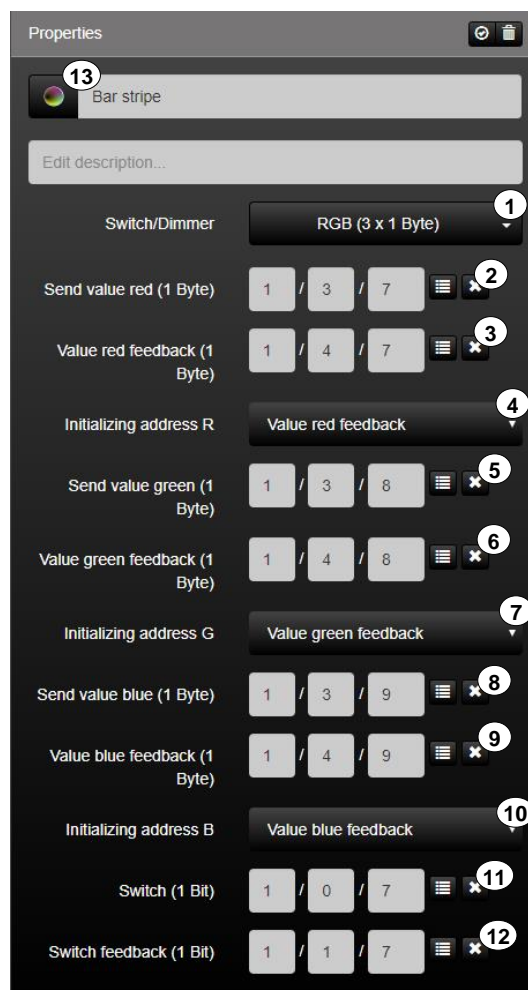


Figure 28: Parameters of the function “RGB (3 x 1 Byte)”

The function has favourites within the symbol library (5). Additional icons are available via the "▼" button.



KNX function	Selection of the icon library in SV-Control	Operating and display element in SV-Home
<p>RGB (3 x 1 Byte)</p>		

Table 7: Display of the "Dimmer" function

RGB (3 Byte):

The function “RGB (3 Byte)” (1) is the KNX function for controlling RGB dimming actuators. With the group address “Send value RGB” (2), all the brightness values of the red, green and blue colour channels can be written on the bus. The group address “Value RGB feedback” (3) can be defined for reading the current brightness of the colour channels.

In addition, the current status of the selected group address of the colour channel can be queried by declaring one of the group addresses “Initializing RGB feedback” (4) on system start. The group address “Switch” (5) can be defined for the central switching of the function. The switching state of the function can likewise be read via the group address “Switch feedback” (6).

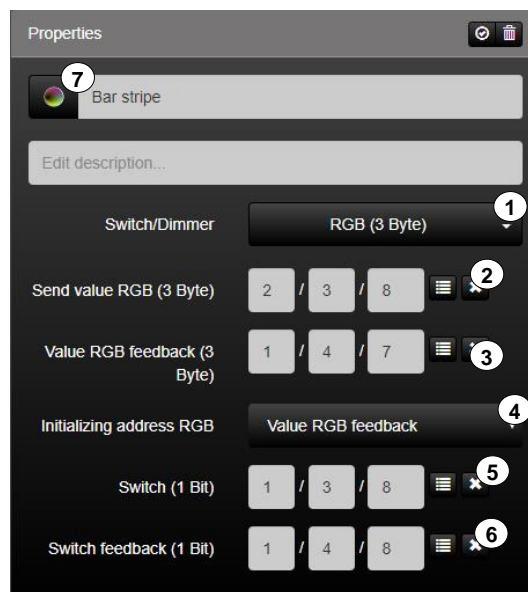


Figure 29: Parameters of the “RGB (3 Byte)” function

The function has favourites within the symbol library (5). Additional icons are available via the "▼" button.


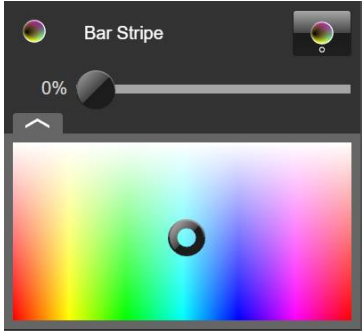
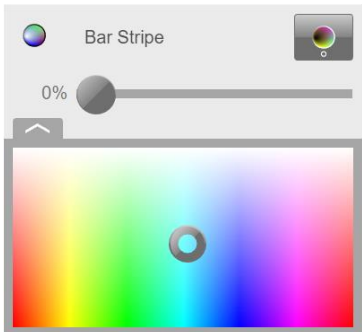
KNX function	Selection of the icon library in SV-Control	Operating and display element in SV-Home
RGB (3 Byte)		
		

Table 8: Display of the “RGB (3 Byte)” function

RGB+W KNX:

The function “RGB+W KNX” (1) is the KNX function for controlling RGBW dimming actuators.

With the group address “Send value RGB” (2), all the brightness values of the red, green and blue colour channels can be written on the bus. The group address “Value RGB feedback” (3) can be defined for reading the current brightness of the colour channel. The “Send value white” (5) is defined separately and has its own feedback address (6).

In addition, the current status of the selected group address of the colour channel can be queried by declaring the “Initializing address RGB” (4), “Initializing address white” (7) and “Initializing address switch” (10) on system start. The group address “Switch” (8) can be defined for the central switching of the function. The switching state of the function can also be read via the “Switch feedback” (9) group address.

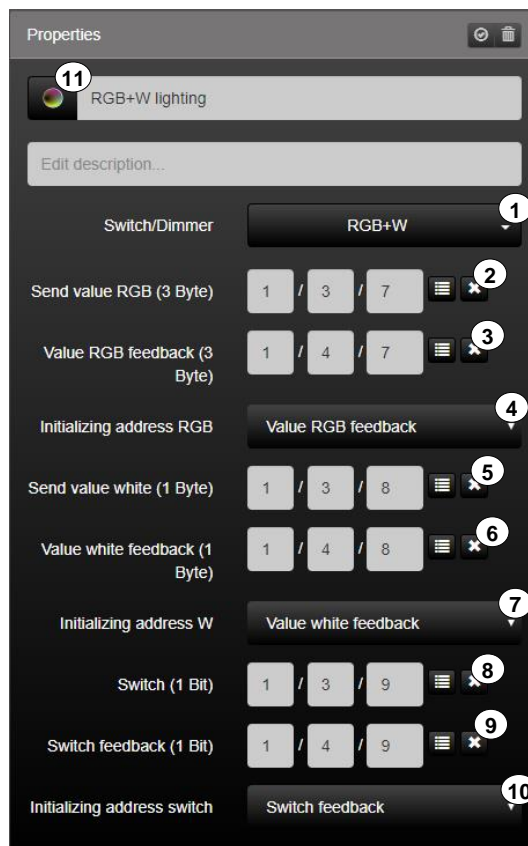


Figure 30: Parameters of the “RGB+W KNX” function

The function has favourites within the symbol library (11). Additional icons are available via the "▼" button.


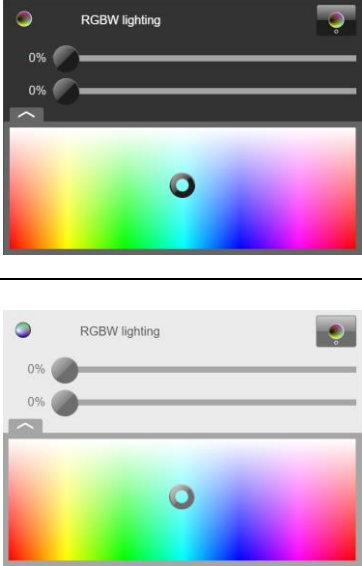
KNX function	Selection of the icon library in SV-Control	Operating and display element in SV-Home
RGBW KNX		

Table 9: Display of the “RGB+W KNX” function

Tunable white KNX:

The function “Tunable white KNX” (1) is the KNX function for controlling Tunable white luminaires. With the group address “Brightness value” (2), the brightness value can be written on the bus. The group address “Brightness value feedback” (3) can be defined for reading the current brightness. The group address “Send value cold white” (5) is used for setting the colour temperature and has its own feedback address (6).

In addition, the current status of the selected group address of the respective channel can be queried by declaring the “Initializing address” (4) and “Initializing address cold white” (7) on system start. The group address “Switch” (8) can be defined for central switching of the function. The switching state of the function can be likewise be read via the group address “Switch feedback” (9).

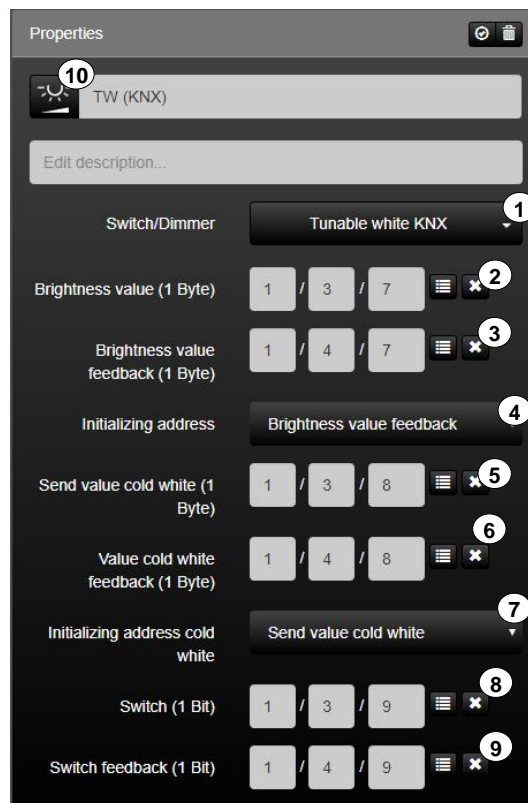


Figure 31: Parameters of the “Tunable white KNX” function

The function has favourites within the symbol library (5). Additional icons are available via the "▼" button.


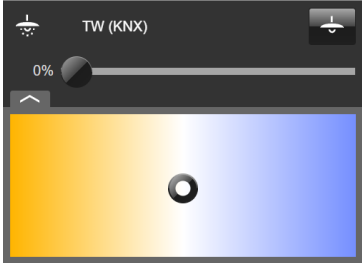
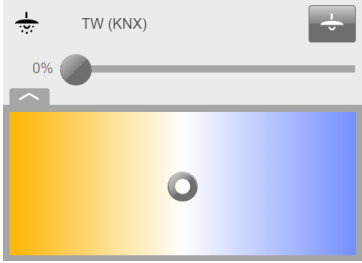
KNX function	Selection of the icon library in SV-Control	Operating and display element in SV-Home
Tunable white KNX		
		

Table 10: Display of the “Tunable white KNX” function

Tunable white Dali:

The function “Tunable white Dali” (1) is the KNX function for controlling Tunable white luminaires. With the group address “Brightness value” (2), the brightness value can be written on the bus. The group address “Brightness value feedback” (3) can be defined for reading the current brightness. The group address “Send value color temperature” (5) is used to set the colour temperature and has its own feedback address (6).

In addition, the current status of the selected group address of the respective channel can be queried by declaring the “Initializing address” (4) and “Initializing address color temperature” (7) on system start. The colour range can further be selected between 0 and 65535 K. The range is set by default between 2500 and 6500 K. The group address “Switch” (8) can be defined for central switching of the function. The switching state of the function can likewise be read via the group address “Switch feedback” (9).

The screenshot shows the 'Properties' window for the 'Tunable white Dali' function. The window is titled 'Properties' and has a close button in the top right corner. The main content area is dark grey with white text. At the top, there is a header bar with a sun icon and the text 'TW (DALI)'. Below this is a text input field for 'Edit description...'. The main configuration area is divided into several sections, each with a label on the left and a control on the right. The controls are: a dropdown menu for 'Switch/Dimmer' (set to 'Tunable white Dali'), three input fields for 'Brightness value (1 Byte)' (1, 3, 7), three input fields for 'Brightness value feedback (1 Byte)' (1, 4, 7), a dropdown menu for 'Initializing address' (set to 'Brightness value feedback'), three input fields for 'Send value color temperature (2 Byte)' (1, 3, 8), three input fields for 'Value color temperature feedback (2 Byte)' (1, 4, 8), a dropdown menu for 'Initializing address color temperature' (set to 'Send value color temperature'), two input fields for 'Range of values' (2500, 6500), three input fields for 'Switch (1 Bit)' (1, 3, 9), and three input fields for 'Switch feedback (1 Bit)' (1, 4, 9). Each control has a small icon to its right, and some have a small 'x' icon. The numbers 1 through 11 are circled in white and point to the following elements: 1: Tunable white Dali dropdown; 2: Brightness value input fields; 3: Brightness value feedback input fields; 4: Brightness value feedback dropdown; 5: Send value color temperature input fields; 6: Value color temperature feedback input fields; 7: Send value color temperature dropdown; 8: Range of values input fields; 9: Switch input fields; 10: Switch feedback input fields; 11: TW (DALI) header.

Figure 32: Parameters of the “Tunable white Dali” function

The function has favourites within the symbol library (5). Additional icons are available via the "▼" button.


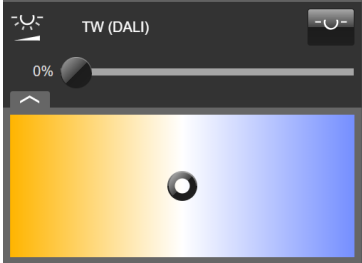
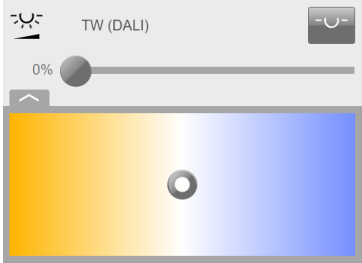
KNX function	Selection of the icon library in SV-Control	Operating and display element in SV-Home
Tunable white Dali		
		

Table 11: Display of the "Tunable white Dali" function

2.5.4.2 Motor

If required, the function type "Motor" can be depicted by one of three KNX functions.

Up/Down/Stop:

The "UP/DOWN/STOP" function (1) is the KNX function for the simple control of motorised drives without feedback objects. The motorised drive can be activated by the group addresses "Long time" (2) and "Short time" (3).

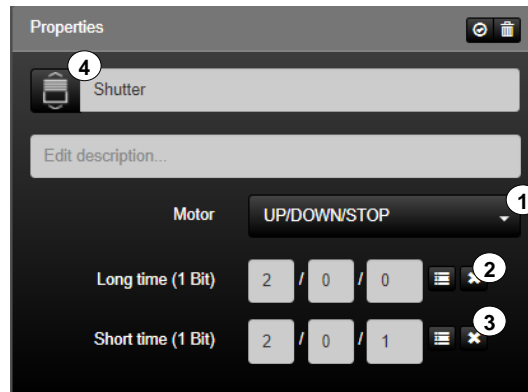


Figure 33: Parameters of the "Up/Down/Stop" function

The function has favourites within the symbol library (4). Additional icons are available via the "▼" button.

KNX function	Selection of the icon library in SV-Control	Operating and display element in SV-Home
Up / Down / Stop		

Table 12: Display of the "Up/Down/Stop" function

Up / Down / Stop (State):

The "UP / DOWN / STOP (State)" function (1) is the KNX function for the simple control of motorised drives with feedback objects. The motorised drive can be activated by the group addresses "Long time" (2) and "Short time" (3).

The "Curtain position feedback" (4) group address must be configured for reading the position. In addition, the current status of a selectable group address can be polled by defining an initialisation address (5) on starting the system.

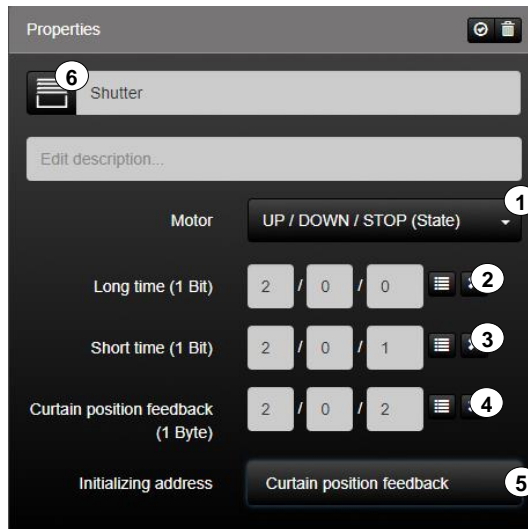


Figure 34: Parameters of the "Up / Down / Stop (State)" function

The function has favourites within the symbol library (6). Additional icons are available via the "▼" button.

KNX function	Selection of the icon library in SV-Control	Operating and display element in SV-Home
Up / Down / Stop (State)		

Table 13: Display of the "Up / Down / Stop (State)" function

Rollershutter/Awning:

The "Rollershutter/Awning" function (1) is the KNX function for the control of motorised roller shutters/awnings with position specification. The motorised drive can be activated by the group address "Curtain position" (2).

The "Curtain position feedback" (3) group address must be configured for reading the position. In addition, the current status of a selectable group address can be polled by defining an initialisation address (4) on starting the system.

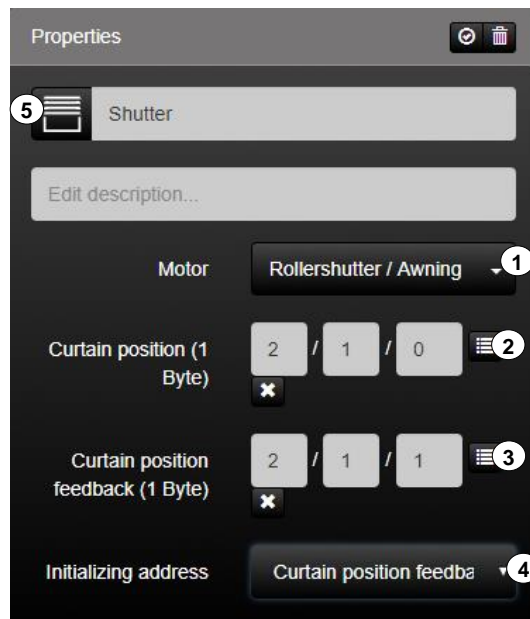


Figure 35: Parameters of the "Rollershutter/Awning" function

The function has favourites within the symbol library (5). Additional icons are available via the "▼" button.


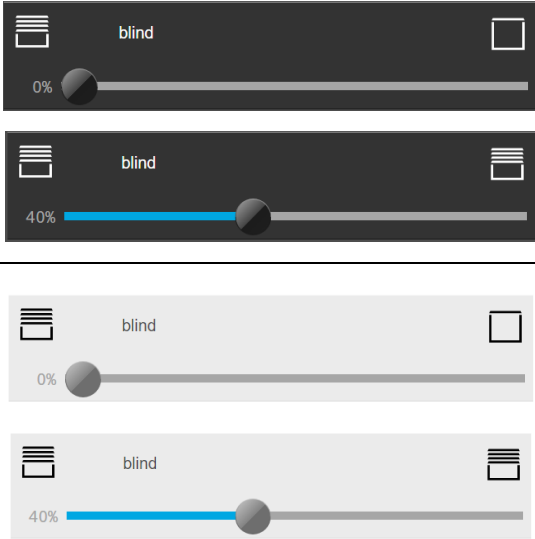
KNX function	Selection of the icon library in SV-Control	Operating and display element in SV-Home
Rollershutter/Awning		

Table 14: Display of the "Rollershutter/Awning" function

Venetian Blinds (Slider):

The "Venetian Blinds (Slider)" function (1) is the KNX function for controlling motorised venetian blinds with position and slat specification. The motorised drive can be activated by the group addresses "Curtain position" (2) and "Slat position" (4).

To read the positions, it is possible to configure the group addresses "Curtain position feedback" (3) and "Slat position feedback" (5).

In addition, the current status of the function can be polled by defining two initialisation addresses (6 - 7) on starting the system.



Figure 36: Parameters of the "Venetian Blinds (Slider)" function

The function has favourites within the symbol library (8). Additional icons are available via the "▼" button.


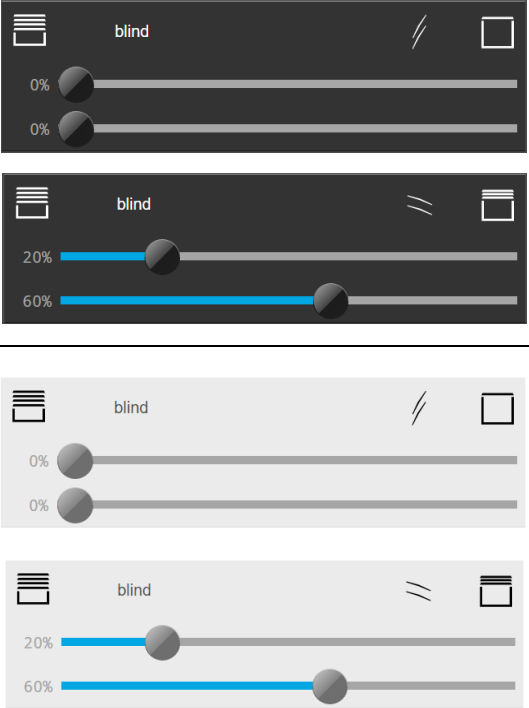
KNX function	Selection of the icon library in SV-Control	Operating and display element in SV-Home
<p>Venetian Blinds (Slider)</p>		

Table 15: Display of the "Venetian Blinds (Slider)" function

Venetian Blinds (Button):

The "Venetian Blinds (Button)" function (1) is the KNX function for controlling motorised venetian blinds with position and slat specification. The motorised drive can be activated by the group addresses "Long time" (2), "Short time" (3), "Position specification" (4) and "Slat specification" (5).

To read the positions, it is possible to configure the group addresses "Curtain position feedback" (6) and "Slat position feedback" (7).

In addition, the current status of the function can be polled by defining two initialisation addresses (8 - 9) on starting the system.

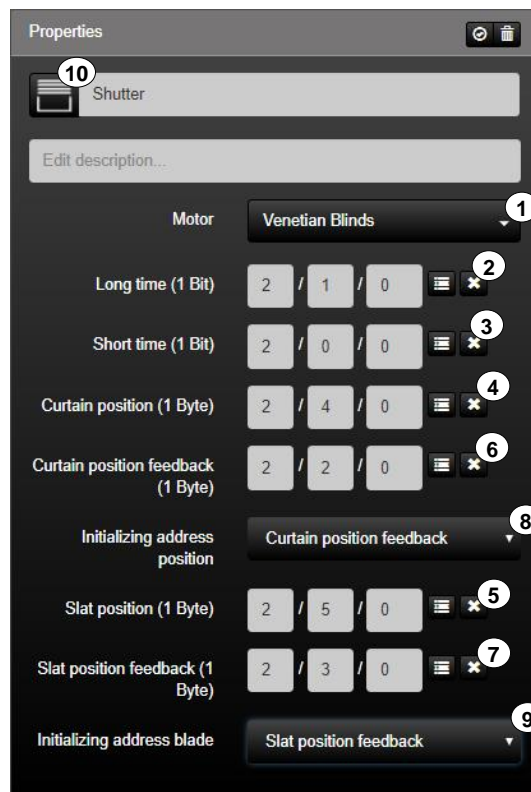


Figure 37: Parameters of the "Venetian Blinds (Button)" function

The function has favourites within the symbol library (10). Additional icons are available via the "▼" button.


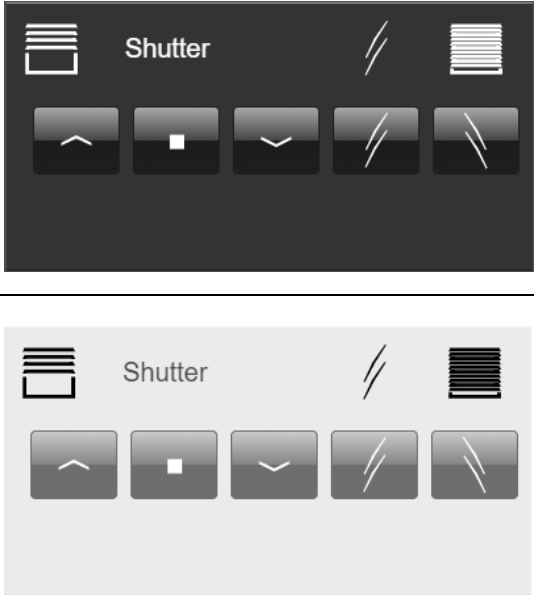
KNX function	Selection of the icon library in SV-Control	Operating and display element in SV-Home
Venetian Blinds (Button)		

Table 16: Display of the "Venetian Blinds (Button)" function

2.5.4.3 Climate

If required, the function group "Climate" can be depicted by various KNX functions.

Ventilate:

The "Ventilate" function (1) allows the display and control of the status of a KNX ventilation controller.

In the input field (2), it is possible to specify the group address for controlling the fan and, in the input field (3), it is possible to enter the group address for the feedback of the currently set fan level.

One of the two group addresses can be selected for the initialisation (4) of the Smart Visu Server on its system start.

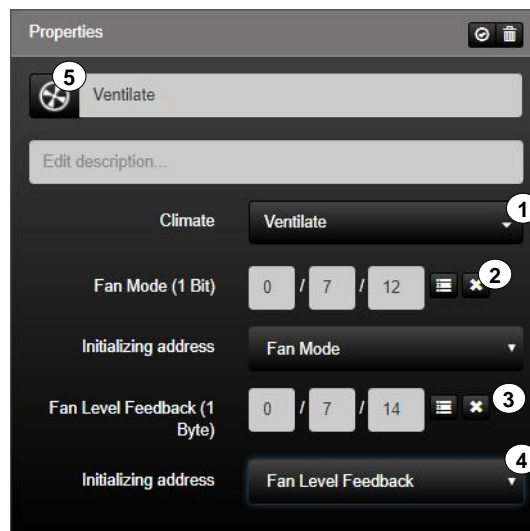


Figure 38: Parameters of the "Ventilate" function

The function has favourites within the symbol library (5). Additional icons are available via the "▼" button.










KNX function	Selection of the icon library in SV-Control	Operating and display element in SV-Home
Ventilate		 Ventilate M 
		 Ventilate A 
		 Ventilate M 
		 Ventilate A 

Table 17: Display of the "Ventilate" function

Operation Mode:

The function "Operation Mode" (1) is the function for switching the different operating modes in accordance with KNX. This can be initiated by the group address "Switch operation mode" (2).

The current operating mode can be read by the group address "Switch operation mode feedback" (3).

In addition, by declaring an initialisation address (4) at system start-up, the current status of the function can be queried.

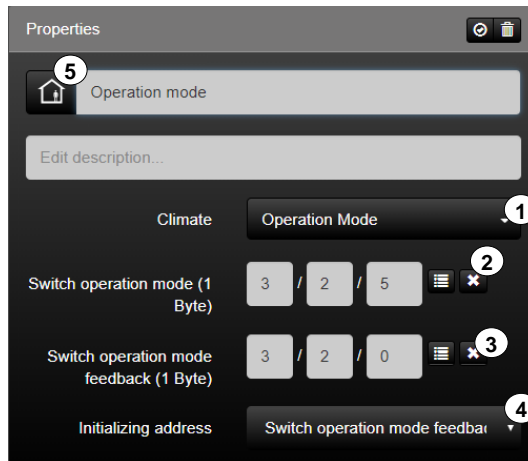


Figure 39: Parameters of the "Operation Mode" function

The function has favourites within the symbol library (5). Additional icons are available via the "▼" button.

KNX function	Selection of the icon library in SV-Control	Operating and display element in SV-Home
Operation Mode		

Table 18: Display of the "Operation Mode" function

HVAC Control Mode:

With the function "HVAC Control Mode" (1), you can switch between heating / cooling and ventilation manual / auto. Switched by the group address "HVAC mode" (2).

The current operating mode can be read by the group address "HVAC mode feedback" (3).

In addition, by defining two initialisation addresses (4) during system start-up, the current status of the function can be queried.

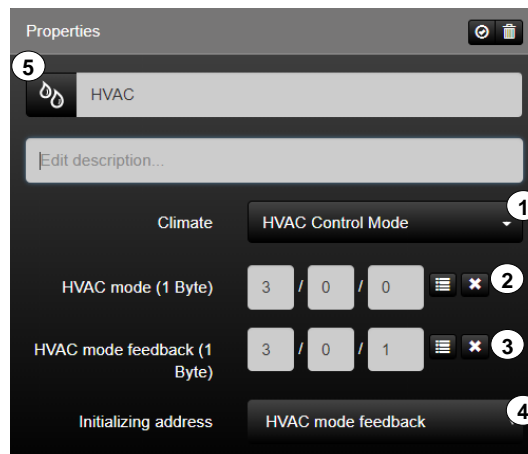


Figure 40: Parameters of the "HVAC Control Mode" function

The function has favourites within the symbol library (5). Additional icons are available via the "▼" button.

KNX function	Selection of the icon library in SV-Control	Operating and display element in SV-Home
HVAC Control Mode		

Table 19: Display of the "HVAC Control Mode" function

Base Setpoint:

The Smart Visu Server supports KNX climate control by specifying a base setpoint (1). The temperature control can be influenced by the group address "Setpoint" (2).

The reading of the current setpoint and the current actual value can be configured by the group addresses "Display temperature" (3) and "Actual temperature" (4).

In addition, by defining three initialisation addresses (5 - 7) at system start-up, the current status of the function can be queried.

Moreover, the "Range of values" (8) can be set individually.

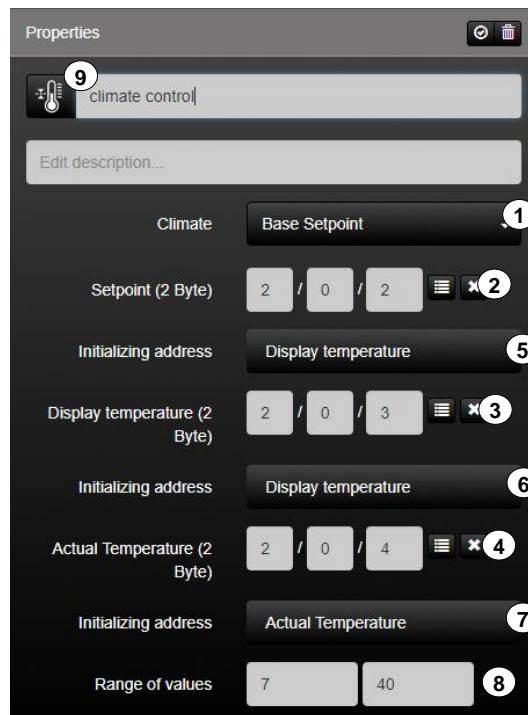


Figure 41: Parameters of the "Base Setpoint" function

The function has favourites within the symbol library (9). Additional icons are available via the "▼" button.

KNX function	Selection of the icon library in SV-Control	Operating and display element in SV-Home
Base Setpoint		

Table 20: Display of the "Base Setpoint" function

Setpoint Shift:

With the function "Setpoint Shift" (1), a KNX climate control can be influenced via the setpoint adjustment. The group address "Setpoint shift" (2) can be used to influence the temperature control.

Reading the current setpoint shift can be configured by the corresponding feedback addresses (3).

Furthermore, the current values can be displayed via the setpoint temperature display (4) and the actual temperature display (8).

In addition, by declaring two initialisation addresses (5-7) at system start-up, the current status of the function can be queried.

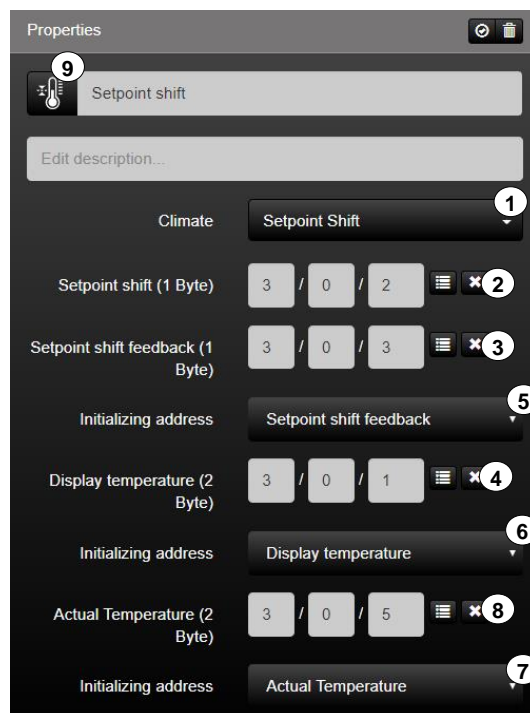


Figure 42: Parameters of the "Setpoint Shift" function

The function has favourites within the symbol library (9). Additional icons are available via the "▼" button.

KNX function	Selection of the icon library in SV-Control	Operating and display element in SV-Home
Setpoint Shift		

Table 21: Display of the "Setpoint Shift" function

HVAC Group:

With the function "HVAC Group" (1), an all-embracing KNX climate control can be initiated. The current setpoint temperature is indicated by the group address "Display temperature" (2) depending on the set operating mode. The group address "Actual temperature" (3) shows the values rounded to one decimal place. The sending and reading of the current setpoint shift (4) can be configured by the corresponding addresses. The current operating mode can be changed and read out by the group addresses "Switch operation mode" or "Switch operation mode feedback" (5).

In addition, by declaring four initialisation addresses (6) during system start-up, the current status of the function can be queried.

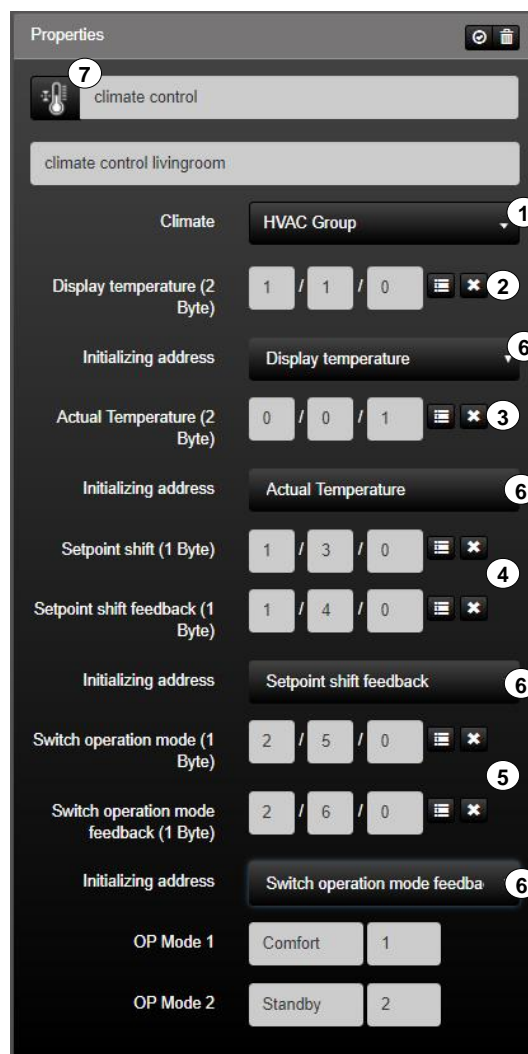


Figure 43: Display of the "HVAC Group" function

The function has favourites within the symbol library (7). Additional icons are available via the "▼" button.

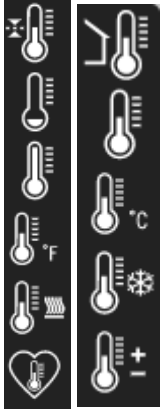
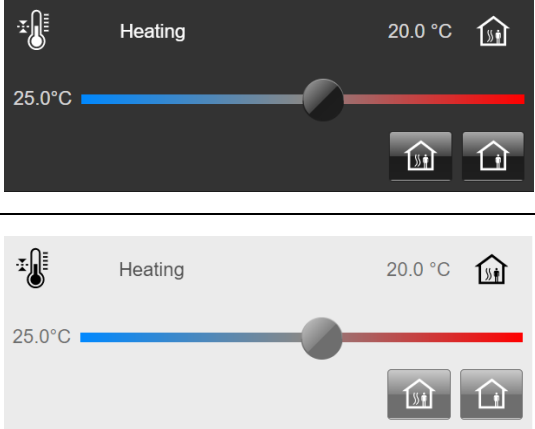
KNX function	Selection of the icon library in SV-Control	Operating and display element in SV-Home
HVAC Group		

Table 22: Display of the “HVAC Group” function

2.5.4.4 Multimedia

Playlist Various:

The "Playlist Various (1)" function is the KNX function for controlling simple multimedia applications.

The volume can be influenced and confirmed by the group addresses "Volume" or "Volume Feedback" (2).

In the input fields (3), the function can read ASCII characters of the registered group addresses (for example, playlist, artist, title). If a text is written to these group addresses, these are visible in the SV-Home.

Furthermore, another playlist (5) or title (6) can be jumped to and another playlist (7) can be selected.

In addition, by declaring two initialisation addresses (8-9) during system start-up, the current status of the function can be queried.

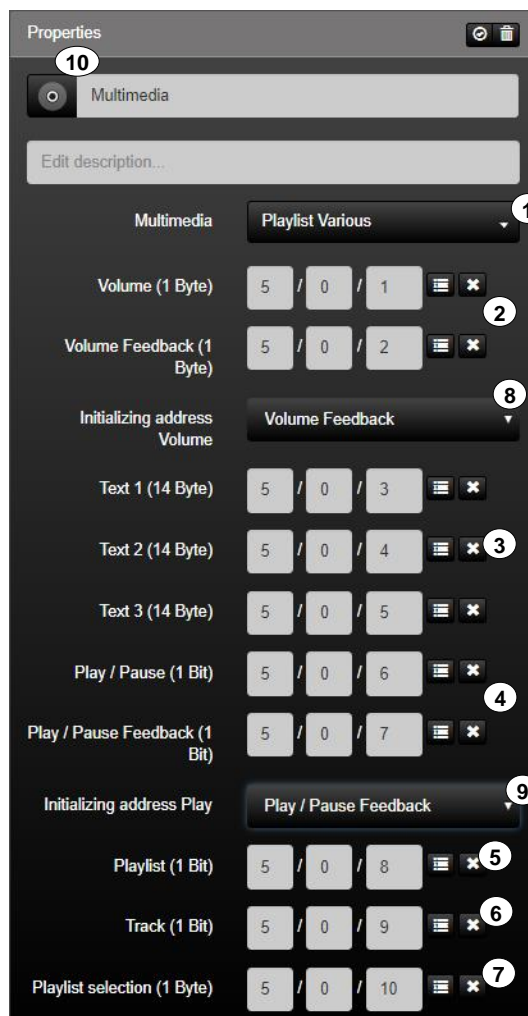


Figure 44: Function "Playlist Various"

The function has favourites within the symbol library (8). Additional icons are available via the "▼" button.


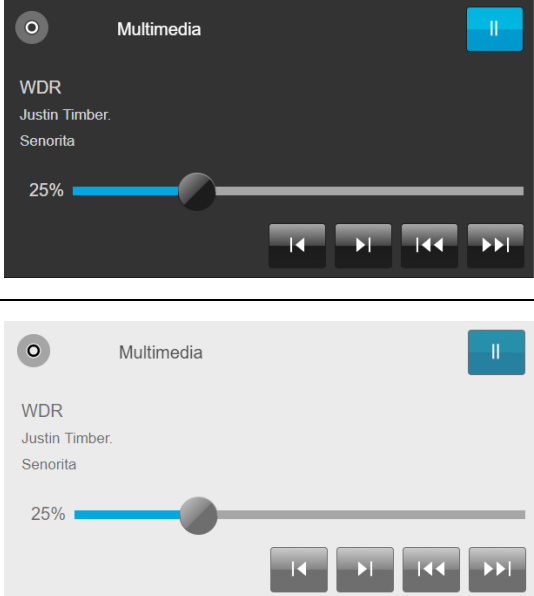
KNX function	Selection of the icon library in SV-Control	Operating and display element in SV-Home
Playlist Various		

Table 23: Display of the “Playlist Various” function

Playlist Mode:

The "Playlist Mode (1)" function is the KNX function for the comprehensive control of multimedia applications.

The volume can be influenced and confirmed by the group addresses "Volume" or "Volume Feedback" (2).

In the input fields (3), the function can read ASCII characters of the registered group addresses (for example, playlist, artist, title). If a text is written to these group addresses in the KNX system, these are visible in the SV-Home.

Playback can be influenced and confirmed by the group addresses "Play / Pause" or "Play / Pause Feedback" (4). Furthermore, a further playlist (5) or title (6) can be started.

The function has the possibility to play the current playlist in a loop (7) or randomly (8).

The function "Playlist selection" (10) can be used to select another playlist.

In addition, by declaring two initialisation addresses (9) during system start-up, the current status of the function can be queried.

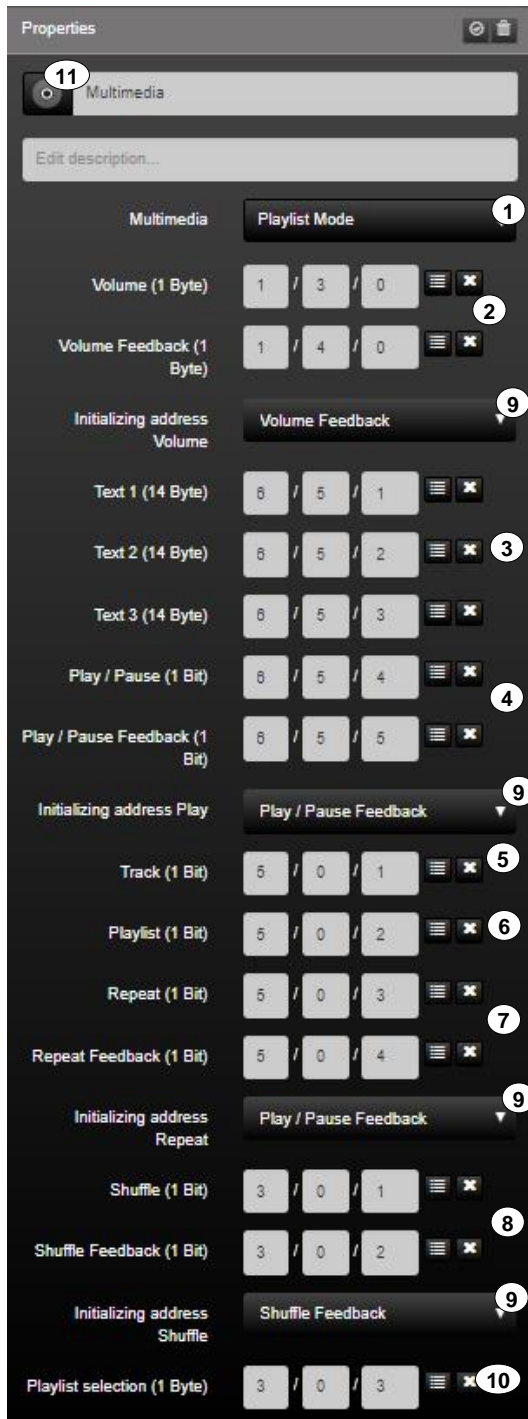


Figure 45: Function “Playlist Mode”

The function has favourites within the symbol library (11). Additional icons are available via the "▼" button.


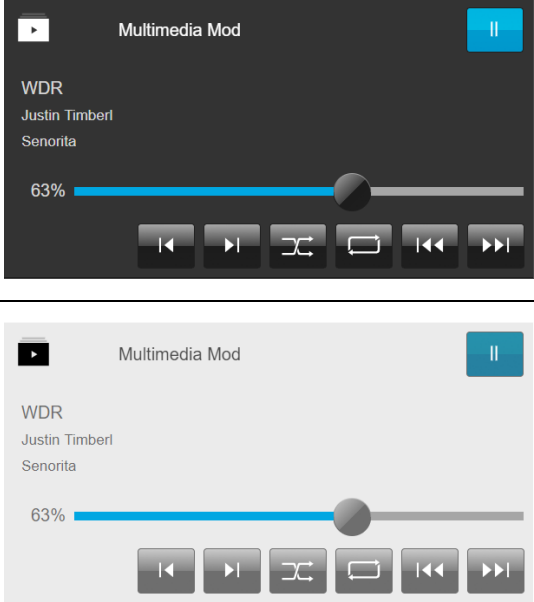
KNX function	Selection of the icon library in SV-Control	Operating and display element in SV-Home
<p>Playlist Mode</p>		

Table 24: Display of the "Playlist Mode" function

Multimedia Sonos:

The "Multimedia Sonos (1)" function is the KNX function for the comprehensive control of multimedia applications.

The volume can be influenced and confirmed by the group addresses "Volume" or "Volume Feedback" (2).

In the input fields (3), the function can read ASCII characters of the registered group addresses (for example, playlist, artist, title). If a text is written to these group addresses in the KNX system, these are visible in the SV-Home.

Playback can be influenced and confirmed by the group addresses "Play / Pause" or "Play / Pause Feedback" (4). Furthermore, a further playlist (5) or title (6) can be started.

The function has the possibility to play the current playlist in a loop (7) or randomly (8). In addition, by declaring two initialisation addresses (9) during system start-up, the current status of the function can be queried.

You can play different playlists via the "Playlist" group address (9). For this purpose, sonos loudspeakers can be connected and decoupled by means of the group addresses "Connect" or "Connect Feedback" (10).

In addition, by declaring two initialisation addresses (12) during system start-up, the current status of the function can be queried.

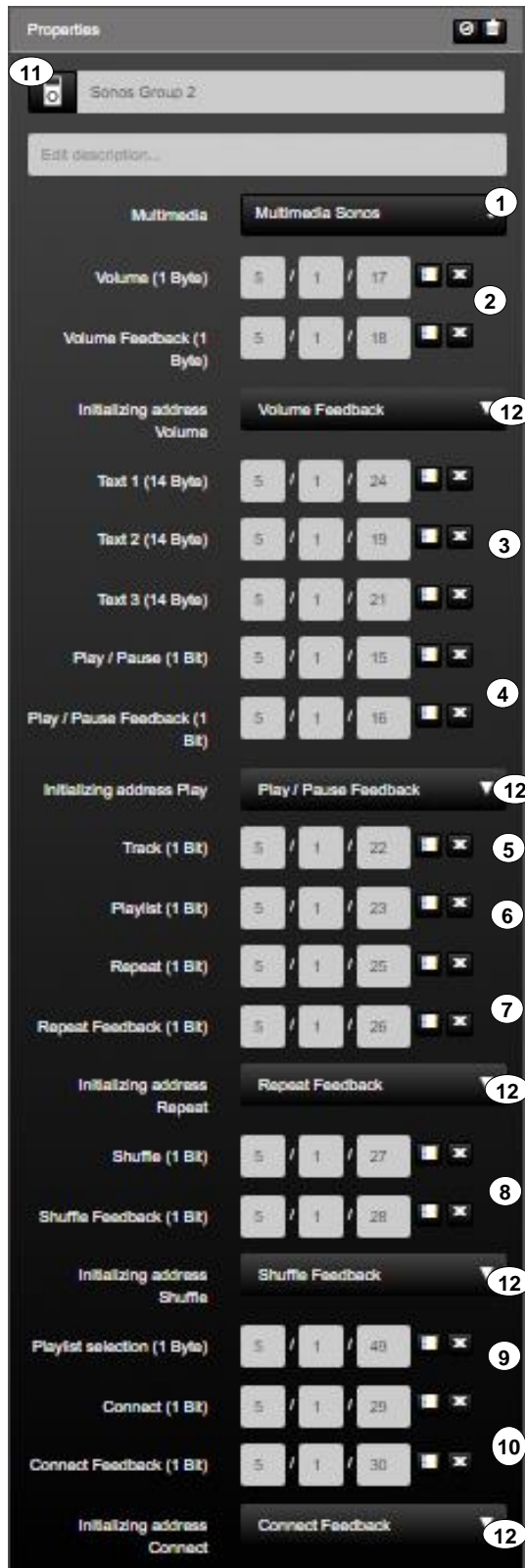


Figure 46: Function "Multimedia Sonos"

The function has favourites within the symbol library (11). Additional icons are available via the "▼" button.


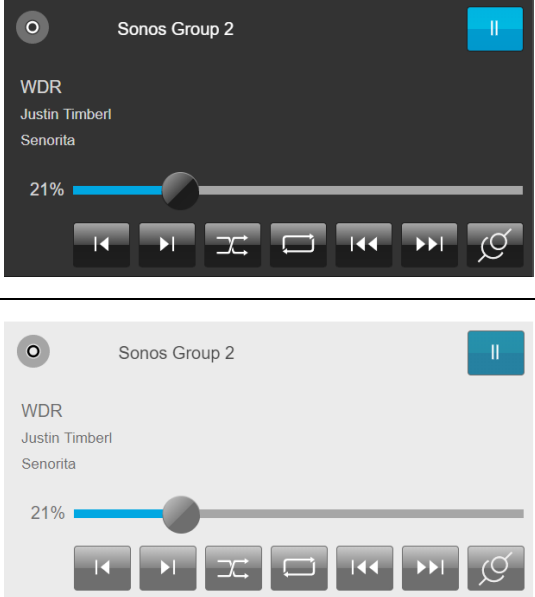
KNX function	Selection of the icon library in SV-Control	Operating and display element in SV-Home
<p>Multimedia Sonos</p>		

Table 25: Display of the "Multimedia Sonos" function

2.5.4.5 Scene

The Smart Visu Server supports the execution and learning of KNX function values. If required, the function type "Scene" can be depicted by two differentiated KNX functions.

Activate Scene:

The "Activate Scene" function (1) is a Smart Visu Server function for executing KNX scenes.

The function transmits a scene value (2) to the KNX group address entered in the input field "Scene group address (1 Byte)" (3). With each KNX scene group address, up to 64 scene values (or scene numbers) (2) can be recalled. The scene value (2) which the Smart Visu Server should transmit when a scene is triggered can be set in the input field (2).

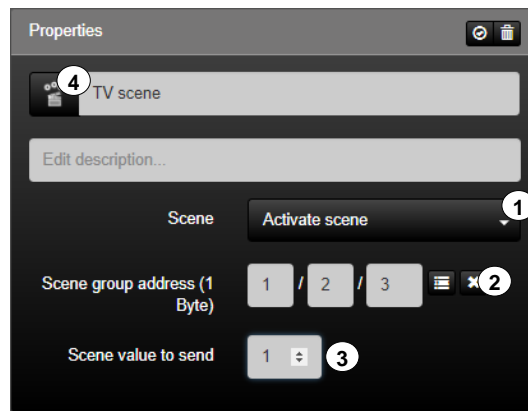


Figure 47: Parameters of the "Activate Scene" function

The function has favourites within the symbol library (4). Additional icons are available via the "▼" button.

KNX function	Selection of the icon library in SV-Control	Operating and display element in SV-Home
Activate Scene		

Table 26: Display of the "Activate Scene" function

Activate & Learn scene (KNX):

The "Activate and Learn scene (KNX)" function (1) is a Smart Visu Server function for executing KNX scenes. This is currently only with a terminal (PC or similar) including mouse usable.

The function transmits a scene value (2) to the KNX group address entered in the input field "Scene group address (1 Byte)" (3). With each KNX scene group address, up to 64 scene values (or scene numbers) (2) can be recalled. The scene value (2) which the Smart Visu Server should transmit when a scene is triggered can be set in the input field (2).

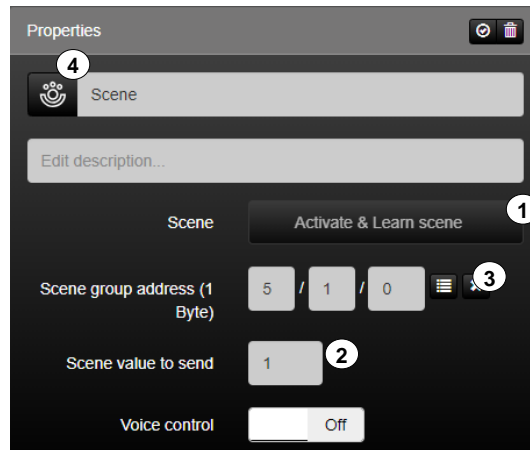


Figure 48: Parameters of the "Activate & Learn scene" function

The function has favourites within the symbol library (4). Additional icons are available via the "▼" button.

KNX function	Selection of the icon library in SV-Control	Operating and display element in SV-Home
Activate & Learn scene		

Table 27: Display of the "Activate & Learn scene" function

2.5.4.6 Value / State

The function type "Value / State" can optionally be mapped by 12 differentiated KNX functions.

Display 1-bit (boolean):

The function "Display 1-bit (Boolean)" (1) is the KNX function for displaying 1-bit status values of the KNX system.

The function reads the KNX group address entered in the input field "Status (1 Bit)" (2). In addition, the current status of the function can be polled by defining two initialisation addresses (3) on starting the system.

The value conversion (4) can be used to invert the result by ticking the box.



Figure 49: Parameters of the "Display 1-bit (boolean)" function

The function has favourites within the symbol library (5). Additional icons are available via the "▼" button.


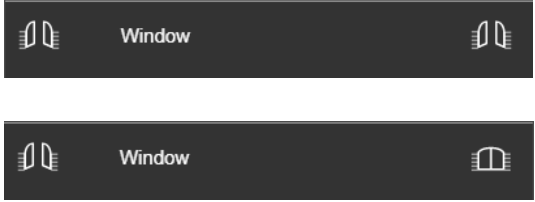
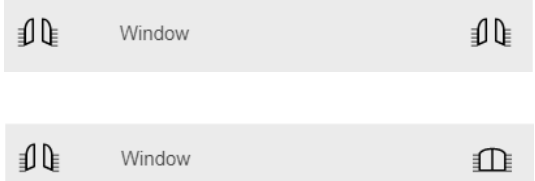
KNX function	Selection of the icon library in SV-Control	Operating and display element in SV-Home
Display 1-bit (boolean)		
		

Table 28: Display of the "Display 1-bit (boolean)" function

Display 1-Byte (0..100%):

The function "Display 1-Byte (0...100%)" (1) is the KNX function for displaying 1-byte integer values (0...100%) in SV-Home.

The function reads the KNX group address entered in the input field "Value (1 Byte)" (2). As values can be sent without a unit in the KNX system, the input field "Unit" (3) can be used to enter an individual unit, which is added to the numerical value in the visualisation.

In addition, the current status of the function can be polled by defining two initialisation addresses (4) on starting the system.

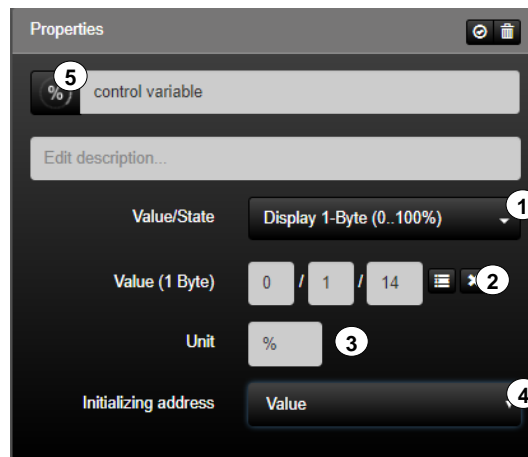


Figure 50: Parameters of the "Display 1-Byte (0...100%)" function

The function has favourites within the symbol library (5). Additional icons are available via the "▼" button.


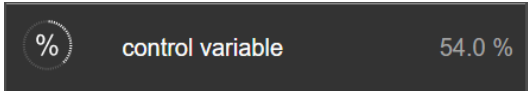
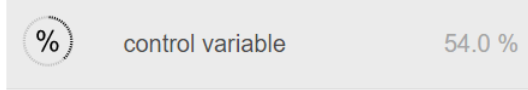
KNX function	Selection of the icon library in SV-Control	Operating and display element in SV-Home
Display 1-Byte (0..100%)		
		

Table 29: Display of the "Display 1-Byte (0...100%)" function

Display 1-Byte (0..255%):

The function "Display 1-Byte (0...255%)" (1) is the KNX function for displaying 1-byte integer values (0...255%) in SV-Home.

The function reads the KNX group address entered in the input field "Value (1 Byte)" (2). As values can be sent without a unit in the KNX system, the input field "Unit" (3) can be used to enter an individual unit, which is added to the numerical value in the visualisation.

In addition, the current status of the function can be polled by defining two initialisation addresses (4) on starting the system.

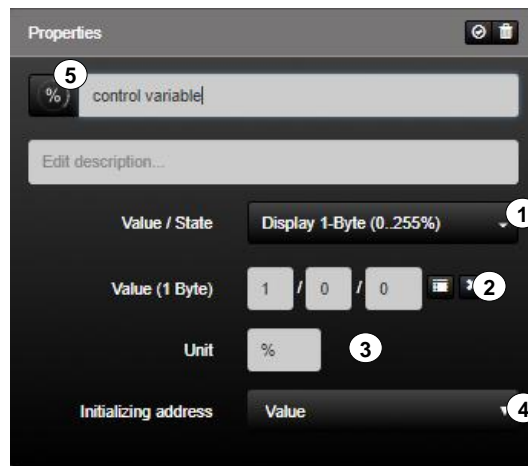


Figure 51: Parameters of the "Display 1-Byte (0..255%)" function

The function has favourites within the symbol library (5). Additional icons are available via the "▼" button.

KNX function	Selection of the icon library in SV-Control	Operating and display element in SV-Home
Display 1-Byte (0..255%)		

Table 30: Display of the "Display 1-Byte (0..255%)" function

Display 1-Byte (0...360°):

The function "Display 1-Byte (0...360°)" (1) is the KNX function for displaying 1-byte integer values (0...306°) in SV-Home.

The function reads the KNX group address entered in the input field "Value (1 Byte)" (2). As values can be sent without a unit in the KNX system, the input field "Unit" (3) can be used to enter an individual unit, which is added to the numerical value in the visualisation.

In addition, the current status of the function can be polled by defining two initialisation addresses (4) on starting the system.



Figure 52: Parameters of the "Display 1-Byte (0...360°)" function

The function has favourites within the symbol library (5). Additional icons are available via the "▼" button.

KNX function	Selection of the icon library in SV-Control	Operating and display element in SV-Home
Display 1-Byte (0 ...360°)		

Table 31: Display of the "Display 1-Byte (0...360°)" function

Display 2-Byte (float):

The function "Display 2-Byte (float)" (1) is the KNX function for displaying KNX 2-byte floating point values in SV-Home. The displayed values are rounded down to the first decimal place.

The function reads the KNX group address entered in the input field "Value (2 Byte)" (2). As only values can be sent without a unit in the KNX system, the input field "Unit" (3) can be used to enter an individual unit, which is added to the numerical value in the visualisation.

In addition, the current status of the function can be polled by defining two initialisation addresses (4) on starting the system.

With the value conversion (5), predefined units can be internally converted to another unit.

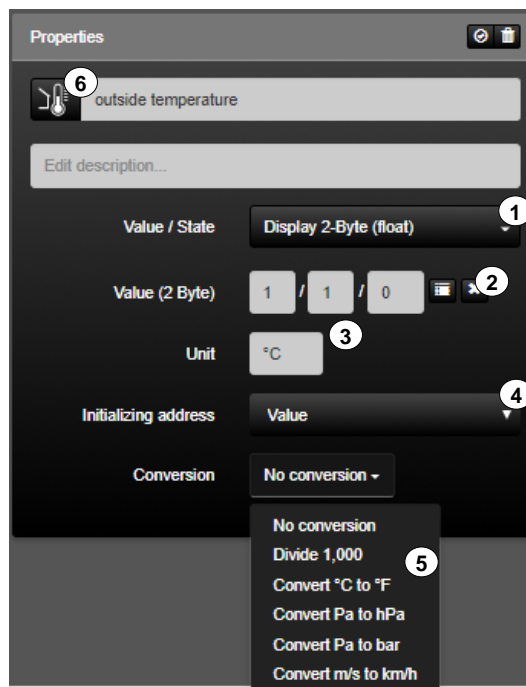


Figure 53: Parameters of the "Display 2-Byte (float)" function

The function has favourites within the symbol library (6). Additional icons are available via the "▼" button.




KNX function	Selection of the icon library in SV-Control	Operating and display element in SV-Home
Display 2-Byte (float)		<div data-bbox="831 443 1361 533" style="background-color: #333; color: white; padding: 5px;">  Outside temperature 21.0 °C </div> <hr/> <div data-bbox="831 752 1361 842" style="background-color: #eee; padding: 5px;">  Outside temperature 21.0 °C </div>

Table 32: Display of the "Display 2-Byte (float)" function

Display 2-Byte (lux):

The function "Display 2-Byte (lux)" (1) is the KNX function for displaying KNX 2-byte lux values in SV-Home. The displayed values are rounded down to the first decimal place.

The function reads the KNX group address entered in the input field "Value (2 Byte)" (2). As only values can be sent without a unit in the KNX system, the input field "Unit" (3) can be used to enter an individual unit, which is added to the numerical value in the visualisation.

In addition, the current status of the function can be polled by defining two initialisation addresses (4) on starting the system.

The value conversion (5) can be used to invert the result by ticking the box.

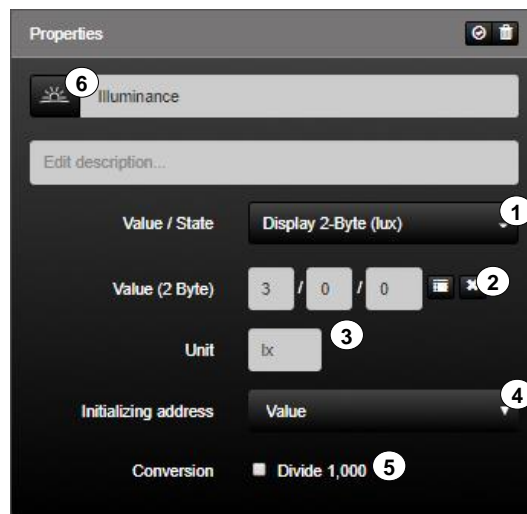


Figure 54: Parameters of the "Display 2-Byte (lux)" function

The function has favourites within the symbol library (6). Additional icons are available via the "▼" button.

KNX function	Selection of the icon library in SV-Control	Operating and display element in SV-Home
Display 2-Byte (lux)		

Table 33: Display of the "Display 2-Byte (lux)" function

Display 2-Byte (time):

The function "Display 2-Byte (time)" (1) is the KNX function for displaying KNX 2-byte time values in SV-Home. The displayed values are rounded down to the first decimal place.

The function reads the KNX group address entered in the input field "Value (2 Byte)" (2). As only values can be sent without a unit in the KNX system, the input field "Unit" (3) can be used to enter an individual unit, which is added to the numerical value in the visualisation.

In addition, the current status of the function can be polled by defining two initialisation addresses (4) on starting the system.

The value conversion (5) can be used to convert the time of seconds into minutes or hours.



Figure 55: Parameters of the "Display 2-Byte (time)" function

The function has favourites within the symbol library (6). Additional icons are available via the "▼" button.



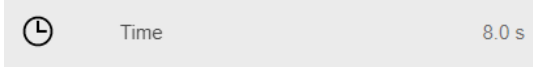
KNX function	Selection of the icon library in SV-Control	Operating and display element in SV-Home
Display 2-Byte (time)		
		

Table 34: Display of the "Display 2-Byte (time)" function

Display 4-Byte (GPS):

The function "Display 4-Byte (GPS)" (1) is the KNX function for displaying KNX 4-byte values (GPS) in SV-Home. The displayed values are rounded down to the first decimal place.

The function reads the KNX group address entered in the input field "Value (4 Byte)" (2). As only values can be sent without a unit in the KNX system, the input field "Unit" (3) can be used to enter an individual unit, which is added to the numerical value in the visualisation.

In addition, the current status of the function can be polled by defining two initialisation addresses (4) on starting the system.

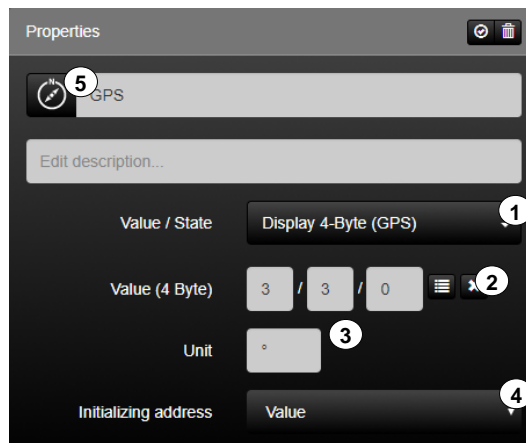


Figure 56: Parameters of the "Display 4-Byte (GPS)" function

The function has favourites within the symbol library (5). Additional icons are available via the "▼" button.



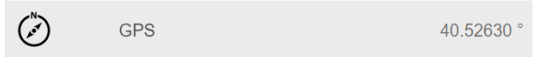
KNX function	Selection of the icon library in SV-Control	Operating and display element in SV-Home
Display 4-Byte (GPS)		
		

Table 35: Display of the "Display 4-Byte (GPS)" function

Display 4-Byte (float):

The function "Display 4-Byte (float)" (1) is the KNX function for displaying positive or negative floating point values of the KNX system in SV-Home. The displayed values are rounded down to the first decimal place.

The function reads the KNX group address entered in the input field "Value (4 Byte)" (2). As values can be sent without a unit in the KNX system, the input field "Unit" (3) can be used to enter an individual unit, which is added to the numerical value in the visualisation.

In addition, the current status of the function can be polled by defining two initialisation addresses (4) on starting the system.

The value conversion (5) can be used to invert the result by ticking the box.

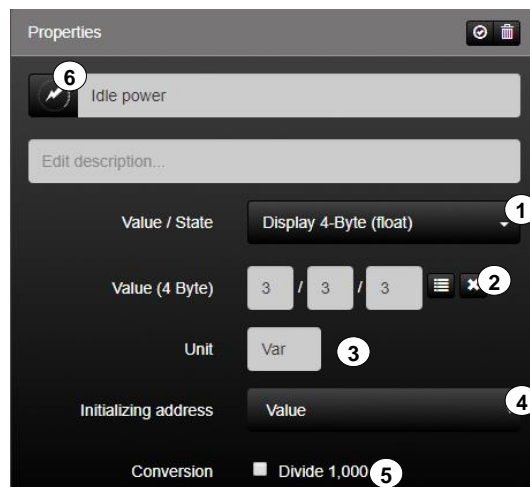


Figure 57: Parameters of the "Display 4-Byte (float)" function

The function has favourites within the symbol library (6). Additional icons are available via the "▼" button.

KNX function	Selection of the icon library in SV-Control	Operating and display element in SV-Home
Display 4-Byte (float)		

Table 36: Display of the "Display 4-Byte (float)" function

Display 4-Byte (unsigned integer):

The function "Display 4-Byte (unsigned integer)" (1) is the KNX function for displaying positive or negative integer values of the KNX system in SV-Home.

The function reads the KNX group address entered in the input field "Value (4 Byte)" (2). As values can be sent without a unit in the KNX system, the input field "Unit" (3) can be used to enter an individual unit, which is added to the numerical value in the visualisation.

In addition, the current status of the function can be polled by defining two initialisation addresses (4) on starting the system.

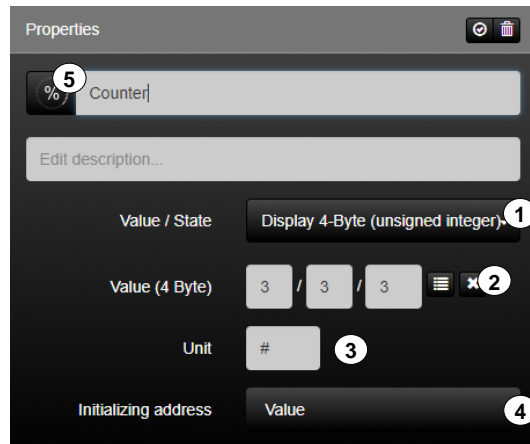


Figure 58: Parameters of the "Display 4-Byte (unsigned integer)" function

The function has favourites within the symbol library (5). Additional icons are available via the "▼" button.

KNX function	Selection of the icon library in SV-Control	Operating and display element in SV-Home
Display 4-Byte (unsigned integer)		

Table 37: Display of the "Display 4-Byte (unsigned integer)" function

Display 4-Byte (integer):

The function "Display 4-Byte (integer)" (1) is the KNX function for displaying positive or negative integer values of the KNX system in SV-Home.

The function reads the KNX group address entered in the input field "Value (4 Byte)" (2). As values can be sent without a unit in the KNX system, the input field "Unit" (3) can be used to enter an individual unit, which is added to the numerical value in the visualisation.

In addition, the current status of the function can be polled by defining two initialisation addresses (4) on starting the system.

The value conversion (5) can be used to invert the result by ticking the box.

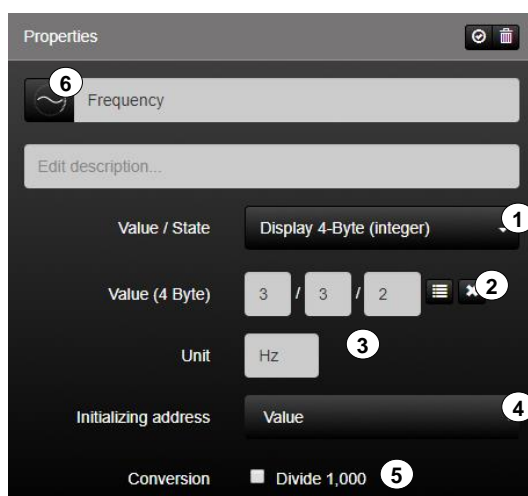


Figure 59: Parameters of the "Display 4-Byte (integer)" function

The function has favourites within the symbol library (6). Additional icons are available via the "▼" button.


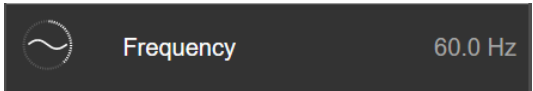
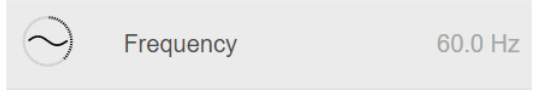
KNX function	Selection of the icon library in SV-Control	Operating and display element in SV-Home
Display 4-Byte (integer)		
		

Table 38: Display of the "Display 4-Byte (integer)" function

Display 14 Byte (ASCII):

The function "Display 14 Byte (ASCII)" (1) is the KNX function for displaying texts of a maximum of 14 characters of the KNX system in SV-Home.

The function can read the ASCII characters in the group address entered in the input field "Value (14 Byte)" (2). If a text is written to this group address in the KNX system, then this can be displayed in SV-Home with this function.

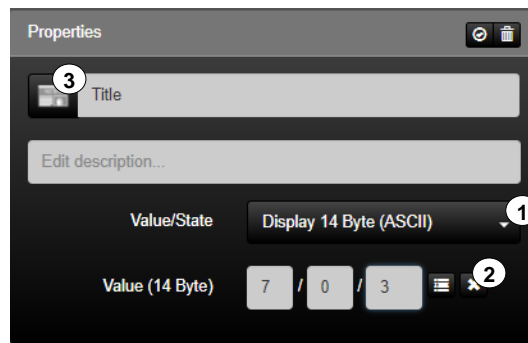


Figure 60: Parameters of the "Display 14 Byte (ASCII)" function

The function has favourites within the symbol library (3). Additional icons are available via the "▼" button.

KNX function	Selection of the icon library in SV-Control	Operating and display element in SV-Home
Display 14 Byte (ASCII)		

Table 39: Display of the "Display 14 Byte (ASCII)" function

Threshold:

The “Threshold” function (1) is the KNX function for converting analogue values into binary values.

The function references existing functions (3) and compares them continuously to an upper/lower limit (2). If the lower limit (2) is exceeded, this corresponds to a result = 0. If the upper limit (2) is exceeded, the result changes to 1. The result can be used to trigger further actions.

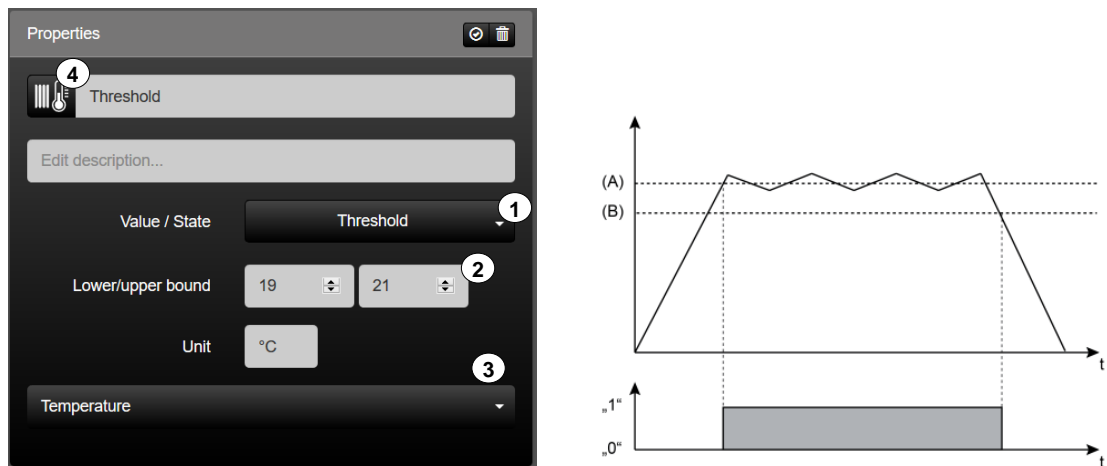


Figure 61: Parameters of the “Threshold” function

The function has favourites within the symbol library (3). Additional icons are available via the "▼" button.

KNX function	Selection of the icon library in SV-Control	Operating and display element in SV-Home
Threshold		

Table 40: Display of the “Threshold” function

IoT controller:

The function “IoT controller” (1) can be used to control IoT devices such as Philips Hue lamps or SONOS speakers.

The function can control different functionalities of IoT devices with an identical data type such as the brightness value / volume or the switching on/off of lamps or speakers. It is possible to search for appropriate functions (2).

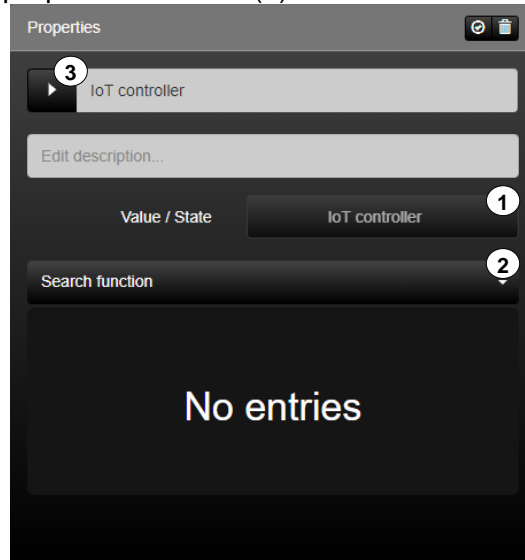



Figure 62: Parameters of the “IoT controller” function

The function has favourites within the icon library (3). Further icons are available via the “” button.


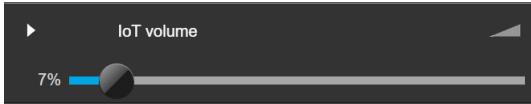
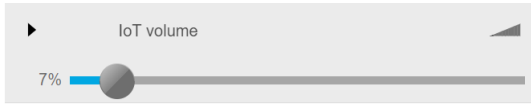
KNX function	Selection of the icon library in SV-Control	Operating and display element in SV-Home
IoT controller		
		

Table 41: Display of the “IoT controller” function

Application example: Controlling SONOS speakers with KNX rotary sensor

The function “IoT controller” uses KNX devices to control IoT devices. In this application example, the volume and the play/pause of a SONOS speaker are controlled via two IoT controller functions using a KNX rotary sensor.

- 1) Create “Switching + Dimming” function for the KNX rotary sensor
 - a. Create “SONOS” function for the SONOS loudspeaker
- 2) Function “Create IoT controller” (1)
 - a. The following functions are selected under “Search function”:
 - Rotary sensor – Switch (1 bit value) (3)
 - SONOS – Play/Pause (4)

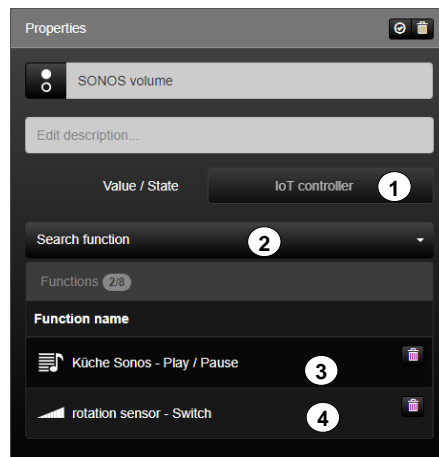


Figure 63: IoT controller function for play/pause via the SONOS speaker

- 3) Create further “IoT controller” functions (5)
 - a. Select the following functions under “Search function” (6):
 - Rotary sensor – Brightness value (1 byte value) (7)
 - SONOS – Volume (8)

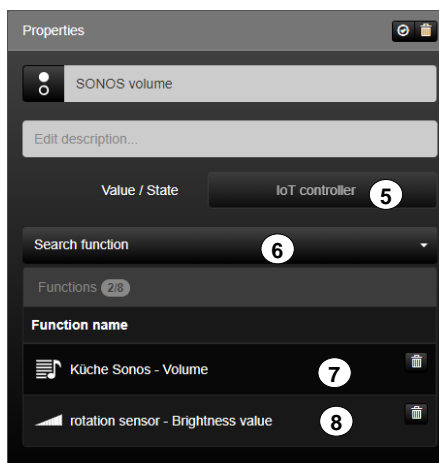


Figure 64: IoT controller function to control the volume of the SONOS speaker

The play/pause and the volume of the SONOS speaker can thus be controlled via the KNX rotary sensor.

Philips Hue:

To regulate the brightness of Philips Hue via the KNX rotary sensor, the “Switch” function of the Hue lamps must be selected instead of SONOS play/pause (4). The same applies to the SONOS volume (8). The brightness value function of the Hue lamps must be selected in this case.

2.5.4.7 Value transmitter

The function type "Value transmitter" can optionally be represented by three differentiated KNX functions.

Send 1-Byte (0...255%):

The function "Send 1-Byte" (1) is the KNX function with which 1-byte percentage values can be set. This is passed on via the group address "Value" (2). In addition, a predefined value can be set via "Value" and the range can be defined via "Range of values" (3).

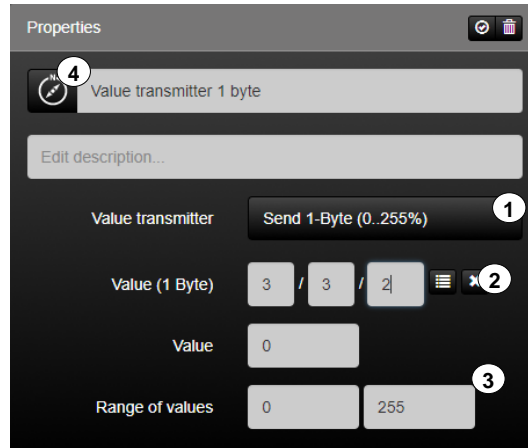


Figure 65: Parameters of the "Send 1-Byte (0...255%)" function

The function has favourites within the symbol library (4). Additional icons are available via the "▼" button.



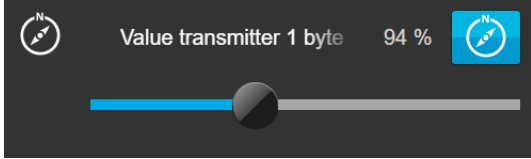
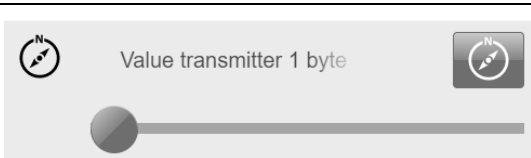
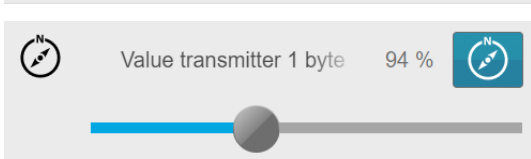
KNX function	Selection of the icon library in SV-Control	Operating and display element in SV-Home
Send 1-Byte (0...255%)		
		
		
		

Table 42: Display of the "Send 1-Byte (0...255%)" function

Send 2-Byte (lux):

The function "Send 2-Byte (lux)" (1) is the KNX function with which 2-byte lux values can be set. This is passed on via the group address "Value" (2). In addition, a predefined value can be set via "Value" and the range can be defined via "Range of values" (3).

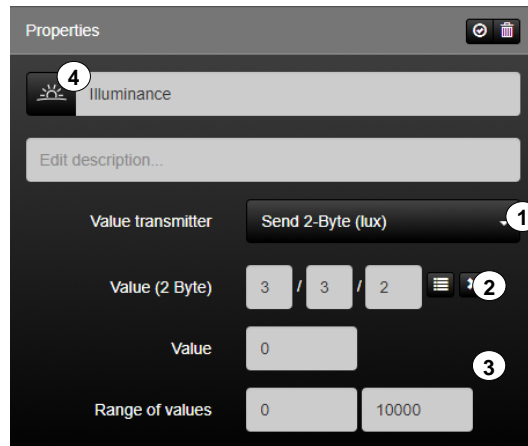


Figure 66: Parameters of the "Send 2-Byte (lux)" function

The function has favourites within the symbol library (4). Additional icons are available via the "▼" button.


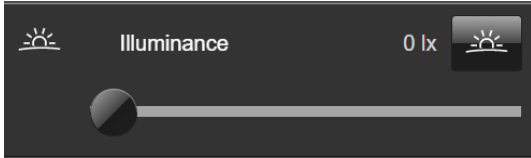
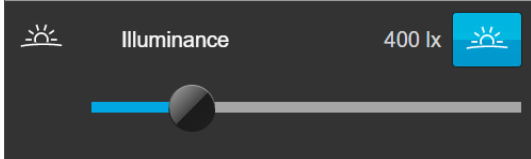
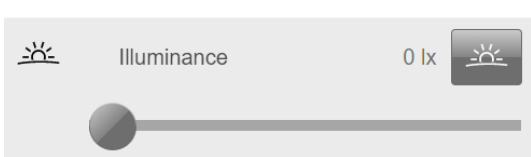
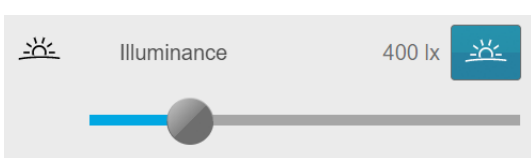
KNX function	Selection of the icon library in SV-Control	Operating and display element in SV-Home
Send 2-Byte (lux)		   

Table 43: Display of the "Send 2-Byte (lux)" function

Send 2-Byte (time):

The function "Send 2-Byte (time)" (1) is the KNX function with which 2-byte time values can be set. This is passed on via the group address "Value" (2). In addition, a predefined value can be set via "Value" and the range can be defined via "Range of values" (3).

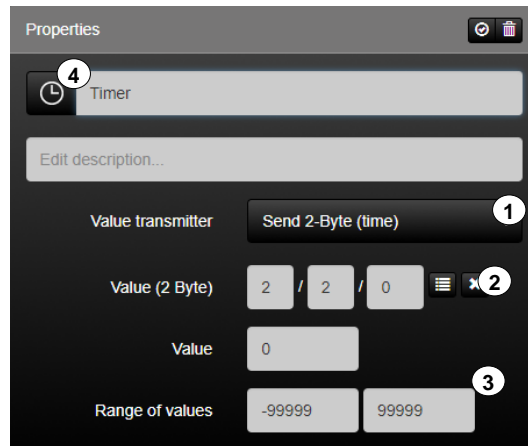


Figure 67: Parameters of the "Send 2-Byte (time)" function

The function has favourites within the symbol library (4). Additional icons are available via the "▼" button.


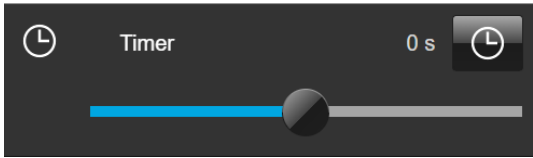
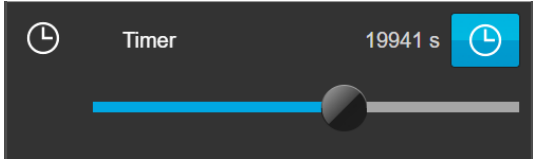

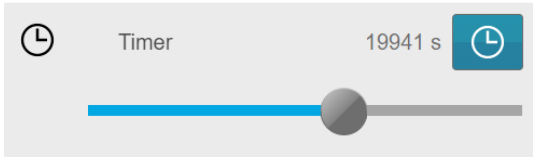
KNX function	Selection of the icon library in SV-Control	Operating and display element in SV-Home
Send 2-Byte (time)		
		
		
		

Table 44: Display of the "Send 2-Byte (time)" function

Date / Time (2 x 3 Byte):

The function “Date / Time (2 x 3 Byte)” (1) is the KNX function which enables the current time (2) and date (3), each with a 3-byte time value.

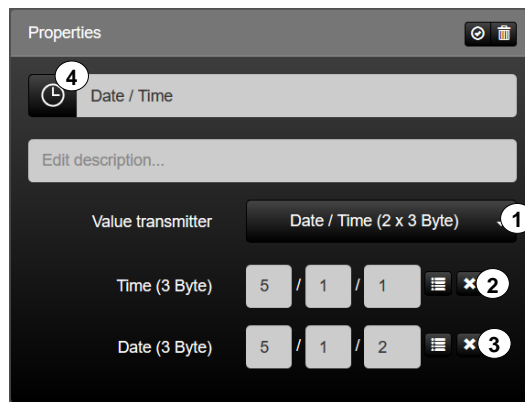


Figure 68: Parameters of the function “Date / Time (2 x 3 Byte)”

The function sends the current server time / current server date on the KNX bus cyclically every hour and after each restart. It is therefore imperative to set the server time in the correct time zone.

The function has favourites within the symbol library (4). Additional icons are available via the "▼" button.


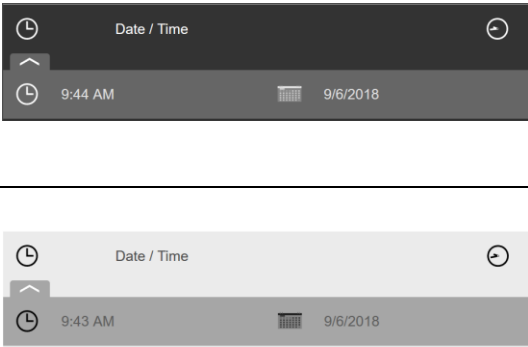
KNX function	Selection of the icon library in SV-Control	Operating and display element in SV-Home
Date / Time (2 x 3 Byte)		

Table 45: Display of the “Date / Time (2 x 3 Byte)” function

Date + Time (1 x 8 Byte):

The function “Date + Time (1 x 8 Byte)” (1) is the KNX function which enables the current time and date (2) to be set with an 8-byte time value.

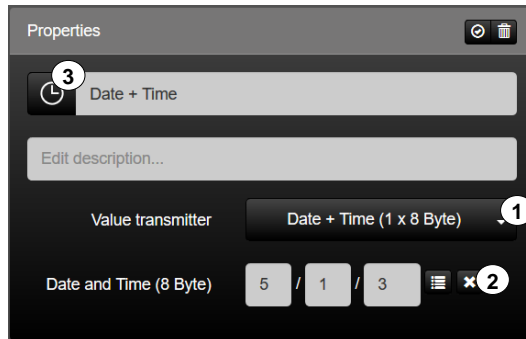


Figure 69: Parameters of the function “Date + Time (1 x 8 Byte)”

The function sends the current server time / current server date on the KNX bus cyclically every hour and after each restart. It is therefore imperative to set the server time in the correct time zone.

The function has favourites within the symbol library (4). Additional icons are available via the "▼" button.


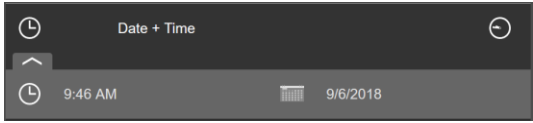

KNX function	Selection of the icon library in SV-Control	Operating and display element in SV-Home
Date + Time (1 x 8 Byte)		
		

Table 46: Display of the “Date + Time (1 x 8 Byte)” function

Application example – Send date and time if required:

The functions “Date / Time (2 x 3 Byte)” and “Date + Time (1 x 8 Byte)” are used to visualise the time and date. The current server time / server date are sent cyclically every hour and after each restart on the KNX bus.

If an update on demand is required, the sending of the current values can be triggered via an action. This can be carried out as user-defined or event-dependent through a group address or a virtual switch. The following example shows event-dependent sending via a virtual switch.

At the start, a new function “Virtual Switch” is created with any name or symbol.

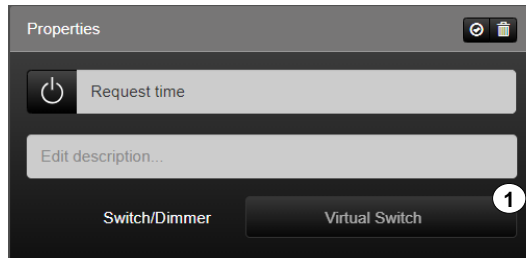


Figure 70: Creating a “Virtual Switch” function

An action is then created with the action type “Event” (2). The action trigger is the previously created “Virtual Switch” (3). Following a change in the status (4), the function “Date / Time (2 x 3 Byte)” or “Date + Time (1 x 8 Byte)” is triggered (5). The action can in addition be assigned to an area (6). By pressing the virtual switch, the current server values are sent on the KNX bus.

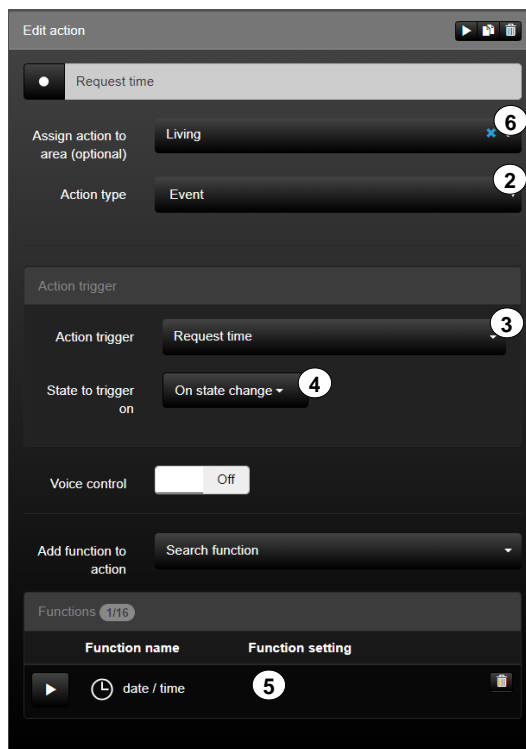


Figure 71: Creating an event-dependent action

2.5.5 SONOS

The “SONOS” function (1) is the function for the comprehensive control of SONOS speakers.

A SONOS speaker can be added under the dropdown menu (2). If a group of SONOS speakers should be controlled with a function, the required speakers must be selected.

It is possible via the function to switch on and off, adjust the volume, select playlists as well as couple and decouple the speakers.

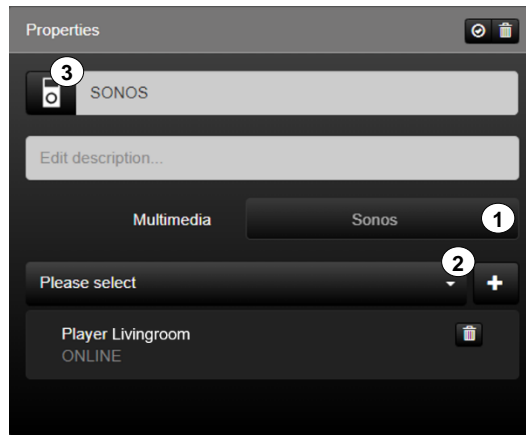



Figure 72: Parameters of the function “SONOS”

The function has favourites within the icon library (2). Further icons are available via the “” button.


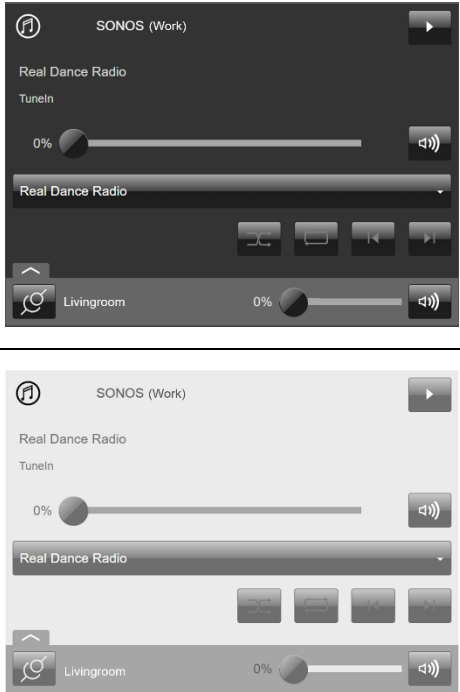

function	Selection of the icon library in SV-Control	Operating and display element in SV-Home
SONOS		

Table 47: Display of the “SONOS” function

2.5.6 Weather

The function type "weather" can optionally be mapped by five differentiated functions. These function requires location coordinates (latitude and longitude) and will stored under SV-Control configuration management "  " (chapter 2.7).

You can research the location coordinates using various services on the World Wide Web (e.g. www.gps-coordinates.net)

The Astro function can be used both with a local and NTP time.

Astro times:

The function "Astro times" (1) displays the times for today's sunrise, sunset, moonrise and moonset.

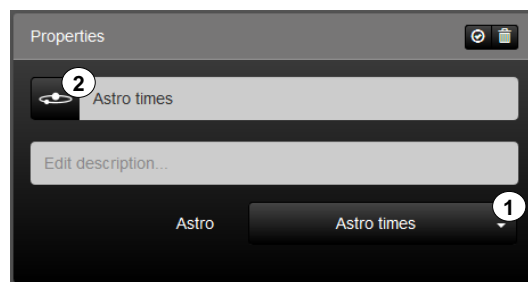



Figure 73: Parameter of the "Astro times" function

The function has favourites within the symbol library (2). Additional icons are available via the "" button.


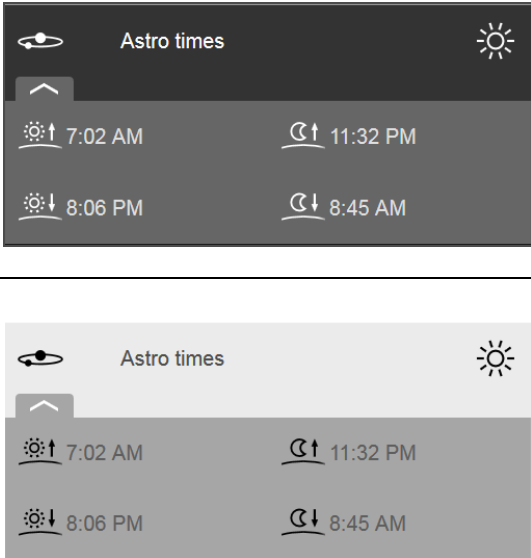
Function	Selection of the icon library in SV-Control	Operating and display element in SV-Home
Astro times		

Table 48: Display of the "Astro times" function

Moonphase:

The function “Moonphase” (1) displays the different phases of the moon with the date and time for the current month.

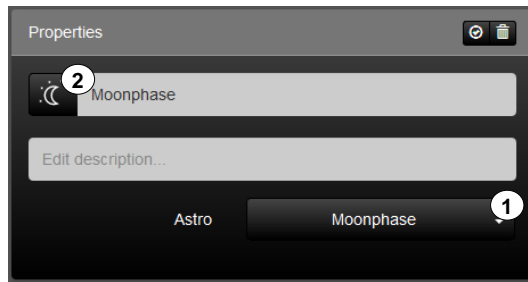


Figure 74: Parameter of the “Moonphase” function

The function has favourites within the symbol library (2). Additional icons are available via the "▼" button.

Function	Selection of the icon library in SV-Control	Operating and display element in SV-Home
Moonphase		

Table 49: Display of the “Moonphase” function

Elevation / Azimuth:

The function "Elevation / Azimuth" (1) displays the current position of the sun (horizontal and vertical) starting from the observation location.

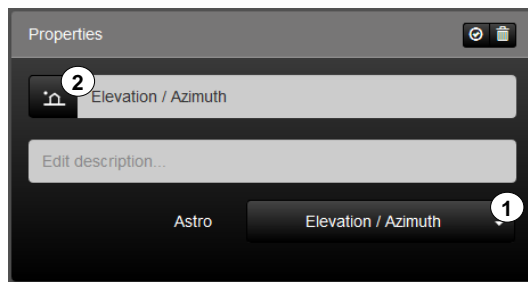


Figure 75: Parameter of the "Elevation / Azimuth" function

The function has favourites within the symbol library (2). Additional icons are available via the "▼" button.

Function	Selection of the icon library in SV-Control	Operating and display element in SV-Home
Elevation / Azimuth		

Table 50: Display of the "Elevation / Azimuth" function

Weather Universal:

The function “Weather Universal” (1) is the KNX function for displaying weather data.

The function displays the current temperature (2), rainfall (3), wind speed (4), pressure (8), humidity (10), brightness (11) and twilight (13). Both wind alerts (6) and (7) are linked via an OR connection and the result is indicated in the SV-Home. Additionally the wind speed can be converted to km/h (5), the pressure to hPa or bar (9) and the brightness to kLux (12). The sunset/sunrise times (14) can also be displayed.

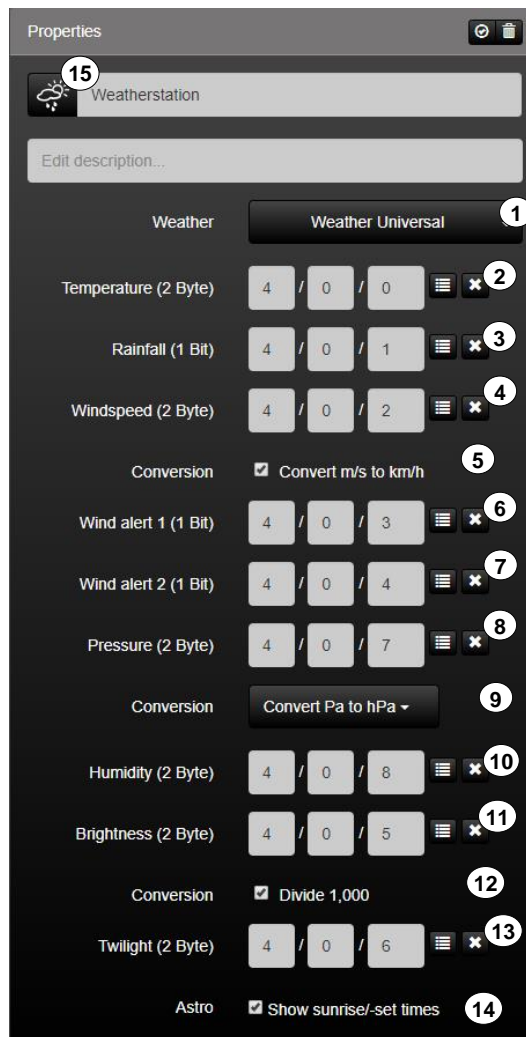


Figure 76: Parameters of the “Weather Universal” function

The function has favourites within the symbol library (15). Additional icons are available via the "▼" button.


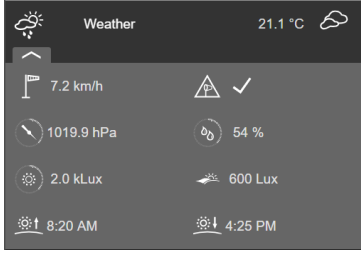
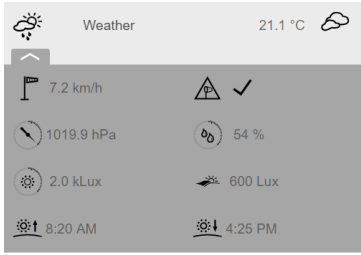
Function	Selection of the icon library in SV-Control	Operating and display element in SV-Home
Weather Universal		
		

Tabelle 51: Display of the "Weather Universal" function

Weather Home:

The function “Weather Home” (1) is the KNX function for displaying weather data.

The function displays the current temperature (2), rainfall (3), wind speed (4), brightness (8) and twilight (10). Both wind alerts (6) and (7) are linked via an OR connection and the result is indicated in the SV-Home. Additionally the wind speed can be converted to km/h (5) and the brightness to kLux (9). The sunset/sunrise times (11) can also be displayed.

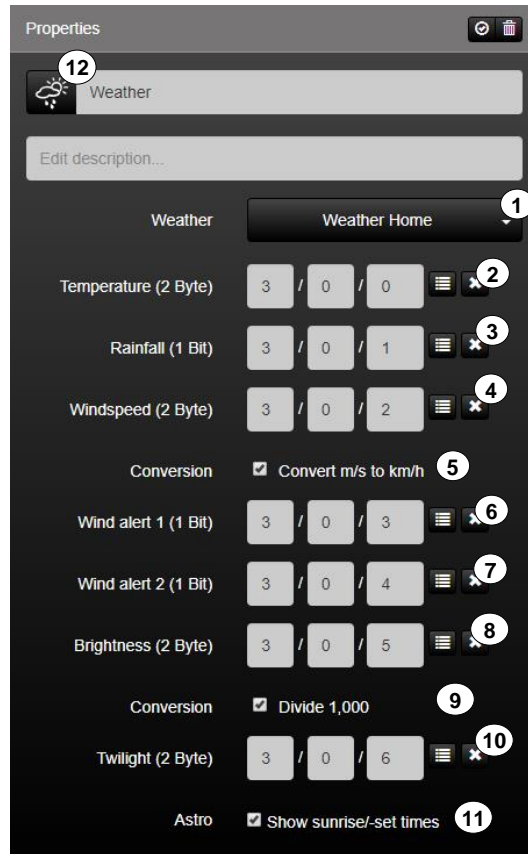


Figure 77: Display of the “Weather Home” function

The function has favourites within the symbol library (12). Additional icons are available via the "▼" button.


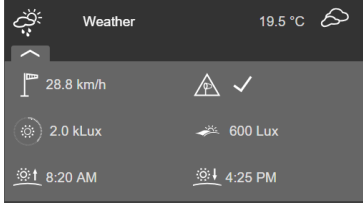
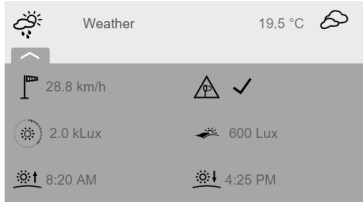
Function	Selection of the icon library in SV-Control	Operating and display element in SV-Home
Weather Home		
		

Table 52: Display of the “Weather Home” function

2.5.7 Configuring Philips Hue functions

Successful commissioning and authentication of the Philips Hue system is required to be able to use Hue functions. The "User" and the "Administrator" have identical access rights to Hue functions within the "Functions" column.

The Hue luminaires added to the SV-Server in the "Hue" tab are automatically supplemented with their name in the function list (for information on Hue setup, please consult Chapter 2.3 "Hue").



Figure 78: Parameters of the "RGB (Hue)" function

In the "Areas & Functions" tab, no further function parameters of the Hue lamps can be edited, with the exception of the icon, the function name and the function description.

Hue lamps	Selection of the icon library in SV-Control	Operating and display element in SV-Home
RGB (Hue)		

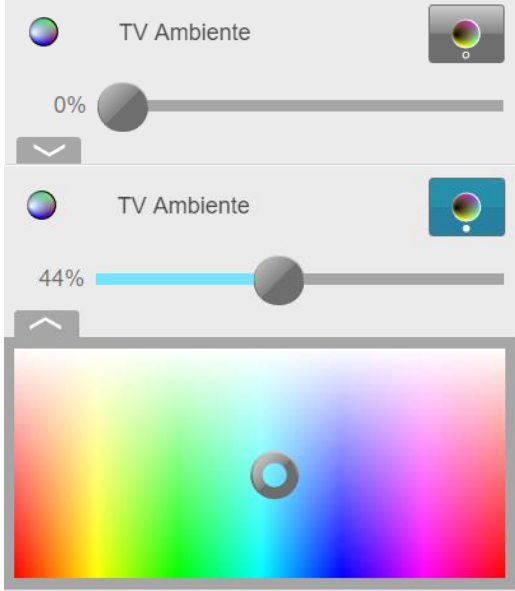



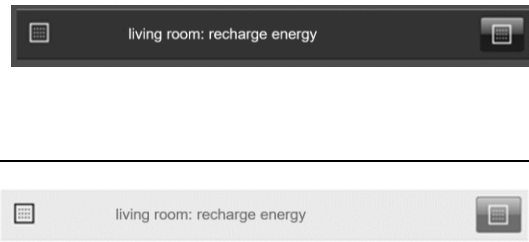
		
Dimming (Hue white)		
Scene (Hue)		

Table 53: Display of the "RGB (Hue)" and "Dimming (Hue white)" function

2.5.8 Configuring websites / IP functions

For web functions to be used, an Internet connection is required (except local IP cameras).

Access as Administrator or User

The "User" and the "Administrator" have different access rights to the web functions within the "Functions" column. The different access rights can be taken from **Fehler! Verweisquelle konnte nicht gefunden werden..**

Access	User		Administrator
	Areas & Function	Web	
Create web functions	✗	✗	✓
Edit names of web functions	✗	✓	✓
Edit icons of web functions	✗	✓	✓
Assign existing web functions to new areas	✗	✓	✓
Delete existing web functions from areas	✗	✓	✓
Change web address, web page size or update interval	✗	✗	✓
Delete existing web functions completely	✗	✗	✓

Table 48: Access rights to the "Website / IP" function group

The following two function types are available to the Administrator in SV-Control:

Function type	KNX function	Settable options	Depiction in SV-Control
Website	Website / IP	URL	
		Dimensions	
		Update interval [in min]	
	IP Cam	URL	
		Dimensions	
		Update interval [in sec]	

Table 54: Overview of the "Website / IP" function group

2.5.8.1 Websites

The "Website" function (1) can be used to integrate a website in SV-Home into selectable areas. This function can be used, for example, to add your favourite weather forecasting service to your building automation. In the same way, any other websites can be added to the user interface of the SV-Home of your building automation.

The web address to be displayed can be entered in the "URL" input field (2). When making an entry, ensure that your entry begins with `http://` or `https://`. Besides Internet addresses, it is also possible to enter local websites using the IP address, e.g. `http://192.168.180.1` of a local device.

Using the two "Dimensions" input fields (3), you can define the depiction size of the website within SV-Home in pixels. As website content can change on a regular basis, you can define a reload time in minutes using the "Update interval" input field (4). After the set time has elapsed, the website is reloaded for display in SV-Home.



Figure 79: Parameters of the "Website" function

The "Website" function possesses the following individualisation options within the icon library (5).


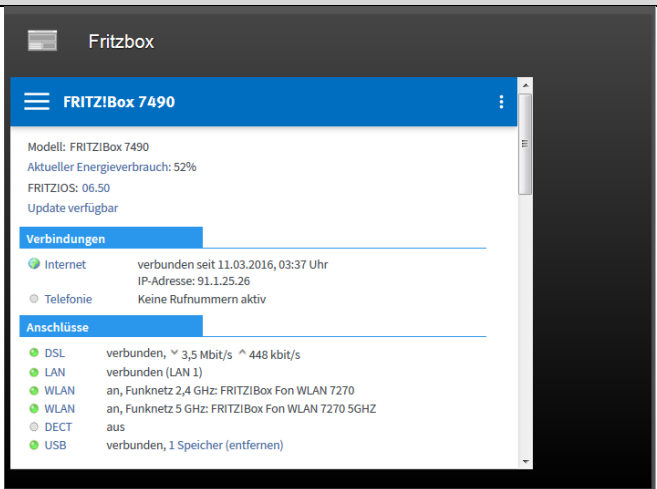
Website / IP	Selection of the icon library in SV-Control	Operating and display element in SV-Home
Website		

Table 55: Display of the "Website" function

2.5.8.2 IP camera

The "IP Cam" function (1) can be used to integrate an IP camera in the Smart Visu Server into selectable areas. This means that it is possible within the user interface of your SV-Home to, for example, display a live image of your entrance area from an IP camera. Local IP cameras cannot be displayed when using the remote access.

The web / IP address to be displayed can be entered in the "URL" input field (2). If there is a username and password assigned to the camera, it is possible to access the camera directly by entering **http://USERNAME:PASSWORD@url -webcam/** in the input field.

Using the two "Dimensions" input fields (3), you can define the depiction size of the website within SV-Home in pixels. You can define a reload time in seconds using the "Update interval" input field (4).

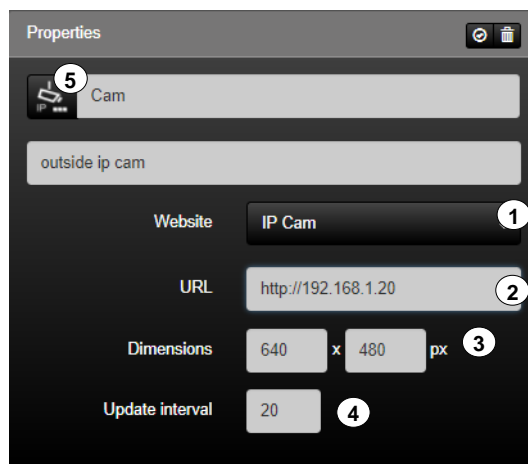


Figure 80: Parameters of the "IP Cam" function

The "Website" function possesses the following individualisation options within the icon library (5).


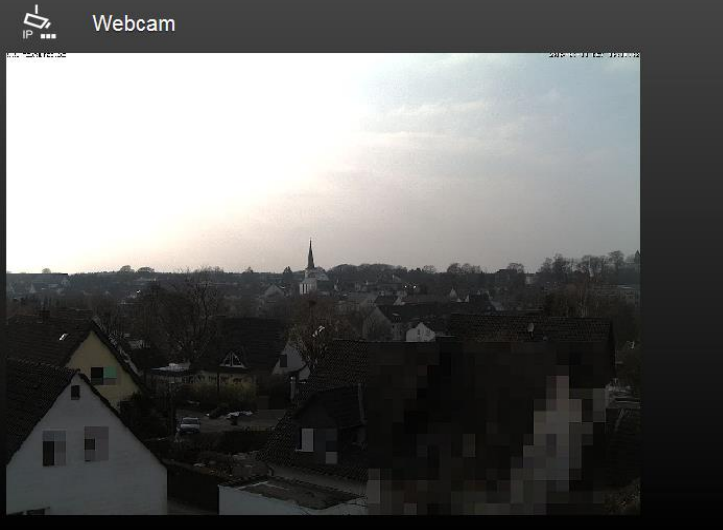
Website / IP	Selection of the icon library in SV-Control	Operating and display element in SV-Home
IP Cam		

Table 56: Display of the "IP Cam" function

2.5.8.3 IP camera : tested Devices

INFORMATION

It's recommended to integrate a maximum of **4 IP cameras** in one SV-Server installation.



If a network camera is integrated with the "**IP Cam**" function, this results in a **permanent** data flow in the home network, **independent** of the SV-Home call.

If a network camera is integrated with the function "**Website**", this **only** requires a data flow in the home network when calling the **assigned SV-Home area**.

Please note:

Some devices cannot be integrated via the function "IP Cam". Alternatively the camera can be integrated by using the "Website" function. Furthermore, local IP cameras are not displayable when using the remote access.


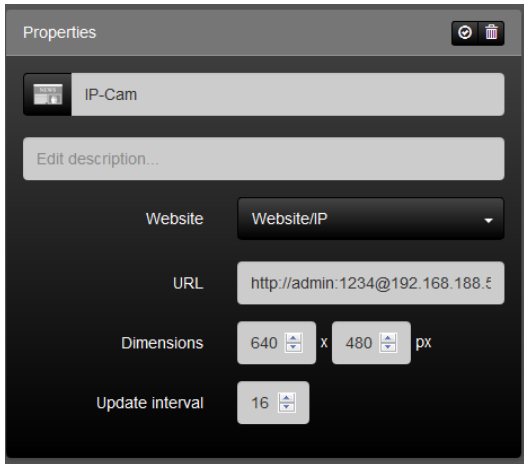
An IP camera can be integrated into the SV-Server in two different ways.

If the camera has an MJPEG stream, it can be inserted in the function "IP Cam". The correct URL can be found on the websites of the manufacturers.


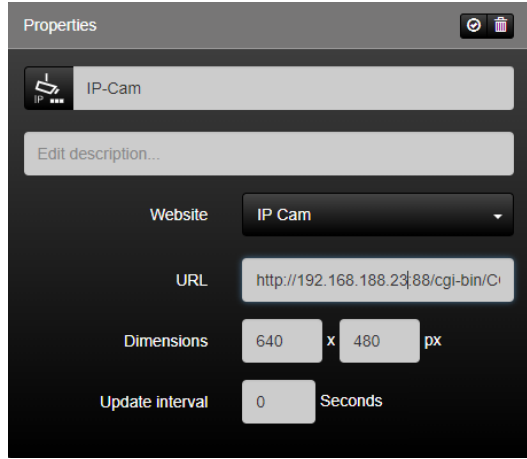
If there is no MJPEG stream available for the IP camera, the "Website / IP" function can call the manufacturer's page with the stream.


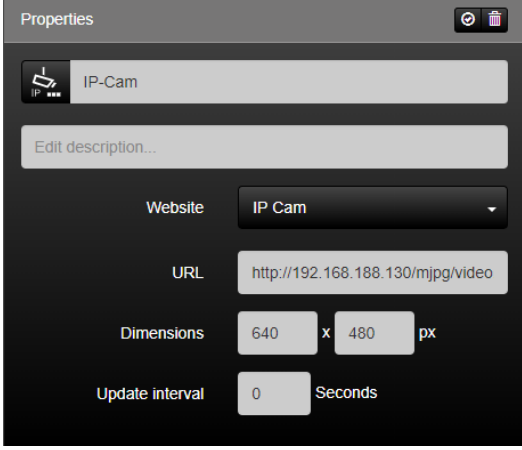
The following chart shows which device operates with which function:
(As at May 2018)


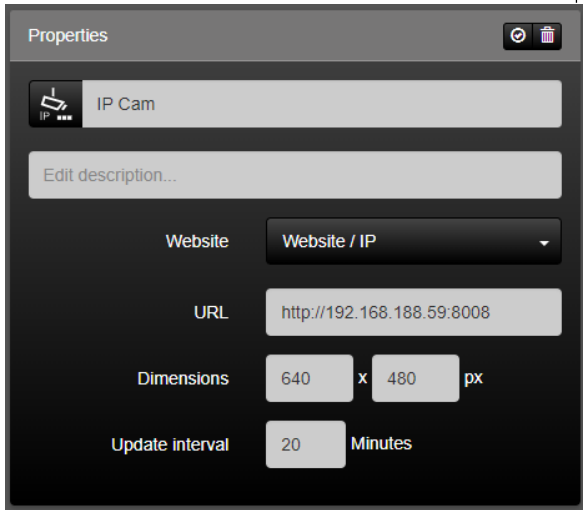
Manufacturer	Figure	Title	Function: IP Cam	Function: Website		
D-LINK		DCS930L	✓	✓		
		Max. resolution	Mode of transmission			
		640 x 480	Network cable / WLAN			
		Operating voltage	IP protection			
		5V / DC	-			
		Configuration				
		IP address:	receive from router			
		User name (default):	admin			
		Password (default):	adminadmin			
		MJPEG address	http:// ip-address /image/jpeg.cgi			
		Comment:	-			
Screenshot:						

Manufacturer	Figure	Title	Function: IP Cam	Function: Website		
Rollei		5040504	X	✓		
		Max. resolution	Mode of transmission			
		1280 x 720	WLAN			
		Operating voltage	IP protection			
		5V / DC	-			
		Configuration				
		IP address:	receive from router http://ip-address/			
		User name (default):	-			
		Password (default):	-			
		MJPEG address	-			
		Comment:	<ul style="list-style-type: none"> • Camera configuration via Rollei app (smartphone e.g.) • Register and get user account (Rollei) • Connect to camera via user name and password (first do registration) • Integrating camera to SV-Server via "Website" function 			
		Screenshot:				

Manufacturer	Figure	Title	Function: IP Cam	Function: Website		
EDIMAX		IC-3116W	✓	✓		
		Max. resolution	Mode of transmission			
		1280 x 720	Network cable / WLAN			
		Operating voltage	IP protection			
		12 V / DC	-			
		Configuration				
		IP address:	receive from router			
		User name (default):	admin			
		Password (default):	1234			
		MJPEG address	http:// ip-address /snapshot.cgi			
Comment:	-					
Screenshot:						

Manufacturer	Figure	Title	Function: IP Cam	Function: Website		
Foscam		FI9804W	✓	✓		
		Max. resolution	Mode of transmission			
		1280 x 720	Network cable / WLAN			
		Operating voltage	IP protection			
		12V / DC	IP 66			
		Configuration				
		IP address:	receive from router IP-address + Port 88 (http://ip-address:88 e.g.)			
		User name (default):	admin			
		Password (default):	(blank)			
		MJPEG address	http:// ip-address :88/cgi-bin/CGIStream.cgi?cmd=GetMJStream&usr= username &pwd= xxx			
Comment:	<ul style="list-style-type: none"> • Calling camera respectively work surface (Foscam) via IP address and "Website" function (browser) • Install manufacturer Plugin (browser asks automatically) • Supports only 32-bit browsers 					
Screenshot:						

Manufacturer	Figure	Title	Function: IP Cam	Function: Website	
Axis		M1124	✓	✓	
		Max. resolution	Mode of transmission		
		8 to 28V DC / PoE	Network cable		
		Operating voltage	IP protection		
		12V / DC	-		
		Configuration			
		IP address:	receive from router		
		User name (default):	root		
		Password (default):	root		
		MJPEG address	http://ip-address/mjpg/video.mjpg?timestamp		
Comment:	<ul style="list-style-type: none"> Calling camera respectively work surface (Axis) via IP address and "Website" function (browser) 				
Screenshot:					

Manufacturer	Figure	Title	Function: IP Cam	Function: Website	
Santec		SNC-5312IR	✘	✔	
		Max. resolution	Mode of transmission		
		1920 x 1080	Network cable		
		Operating voltage	IP protection		
		12 V DC 24 V AC PoE	IP 66		
		Configuration			
		IP address:	receive from router		
		User name (default):	admin		
		Password (default):	9999		
		MJPEG address	http://ip-address:8008		
		Comment:	-		
		Screenshot:	 <p>The screenshot shows a 'Properties' dialog box for an 'IP Cam'. It includes a title bar with a close button and a trash icon. Below the title bar is a header with an IP icon and the text 'IP Cam'. There is a text input field for 'Edit description...'. The main area contains several settings: 'Website' is set to 'Website / IP' in a dropdown menu; 'URL' is 'http://192.168.188.59:8008'; 'Dimensions' are '640 x 480 px'; and 'Update interval' is '20 Minutes'.</p>		

2.5.9 Configuring status logic functions

With the "State Logic" (1) function, the Smart Visu Server can logically link up to 10 functional states. Thus, with status logic, you can, for example, interlink the status of window contacts, so that you can see at a glance in SV-Home whether all the windows are closed.

Access as Administrator or User

The "User" and the "Administrator" have different access rights for the web functions within the "Functions" column. The different access rights can be taken from **Fehler! Verweisquelle konnte nicht gefunden werden..**

Using the "Logic link" drop-down menu (2), you can set these three logical linking operations:

- AND
- OR
- XOR

Using the drop-down menu (4), you can select previously created functions as input variables for the status logic. Only functions containing at least one 1-bit data point can be selected.

The maximum of 10 functions added to the status logic are shown in a list (4). The functions can be deleted individually as input functions from the status logic with the "🗑️" button (5).

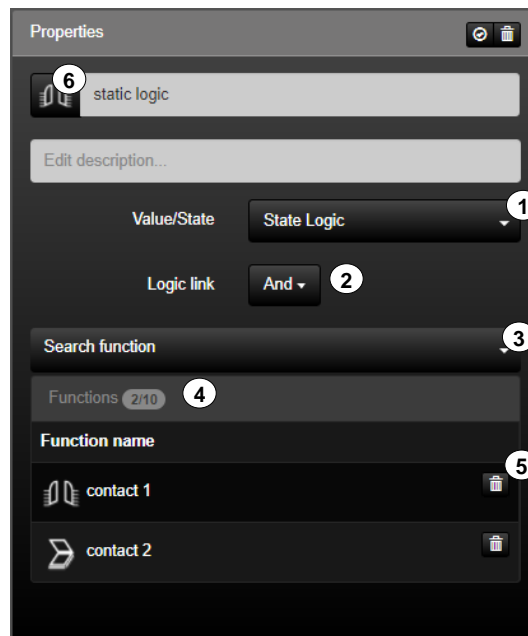


Figure 81: Parameters of "State Logic"

The "State Logic" function (1) has the following individualisation options within the icon library (4).


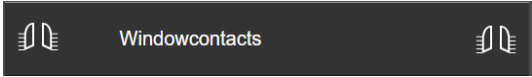
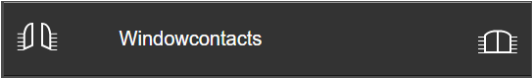
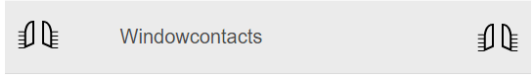
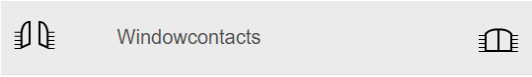
Status logic	Selection of the icon library in SV-Control	Operating and display element in SV-Home
State Logic		 
		 

Table 57: Display of status logic

2.5.10 Configure virtual functions

The "Virtual Switch" function (1) can be used to activate and deactivate action groups and to carry out actions from the SV-Home.

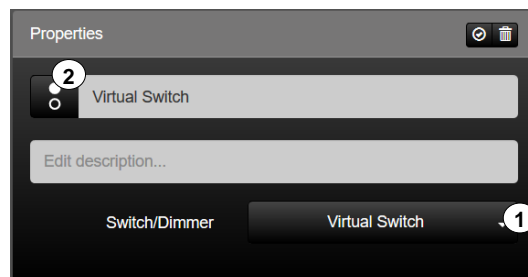


Figure 82: Virtual Switch

The function has favourites within the symbol library (2). Further icons are available via the "▼" button.




Switch	Selection of the icon library in SV-Control	Operating and display element in SV-Home
Virtual Switch		
		

Table 58: Display of the "Virtual Switch" function

2.5.11 Email

The "Email" function (1) is used to send predefined texts as "Event mail" (e.g. the triggering of a [leakage sensor](#)). The recipient must be entered in the "To" field (2). In addition, recipients can be inserted in "Cc" (3) or "Bcc" (4). The subject and the message are entered in fields (5) and (6). So that the device can send emails, a valid SMTP mail server must be entered in the device configuration (see 2.7.5).

Access as Administrator or User

The "User" and the "Administrator" can have different access rights to KNX functions within the "Functions" column. The different access rights can be taken from *2.5 Area & Functions*

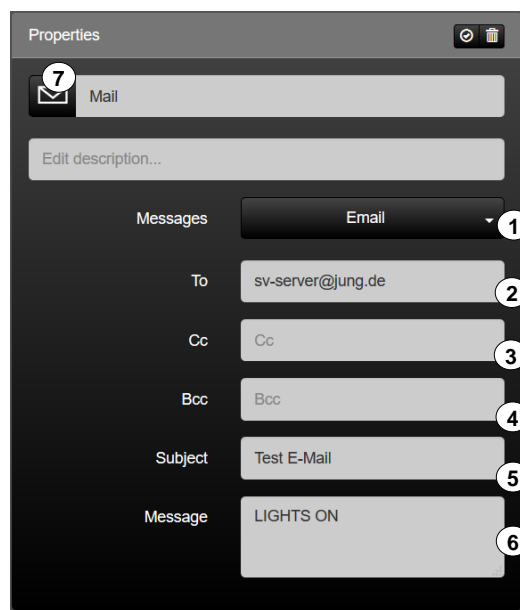


Figure 83: Parameters of the "Email" function

The "Email" function can be used as a trigger function in actions. The functional versatility is hereby clearly increased.

The function has favourites within the symbol library (7). Further icons are available via the "▼" button.

Messages	Selection of the icon library in SV-Control	Operating and display element in SV-Home
Email		

Table 59: Display of the "Email" function

2.5.12 Editing or deleting a function

Access as Administrator or User

The "User" and the "Administrator" have different access rights to KNX functions within the "Functions" column.

Access as Administrator

Select an existing function (1) to edit or delete it. The "Functions" column lists all the existing functions.

The arrow buttons "↑ ↓" (2) enable you to change the order of an area, after selecting it, and thus to move the position in SV-Home. The top most function in SV-Control (from top to bottom) is also displayed as the first function in SV-Home (from top to bottom).

It is possible to change the effect of the selected function (3), assign an alternative icon by pressing the currently selected icon "☰" (4), edit the name of the function (5) and, beneath that, add a description (6).

The changes are automatically saved and briefly displayed by a green "Save successful" screen.

In addition, the button "🔄 / 🗑️" (8) indicates whether the entries of the group addresses are complete. To fully delete the selected area (assuming Administrator rights), press the "🗑️" button (8).

Deletion of an area does not delete the functions assigned to it.

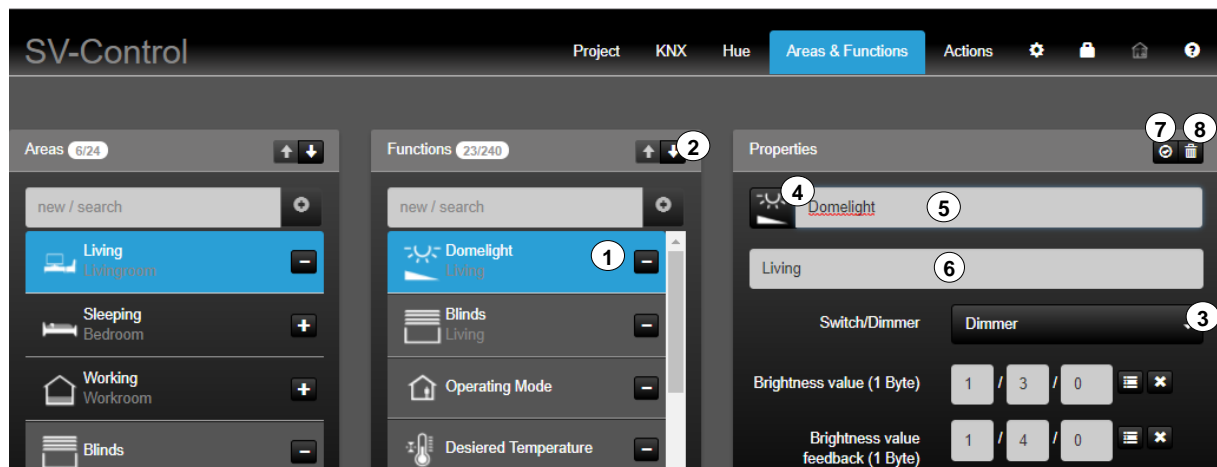


Figure 84: Organisation of the "Areas & Functions" tab

2.6 Action

An action is a grouping of one or more functions. Actions can be triggered by time, events, or via user-defined controls in SV-Home.

An action group can contain several actions.

In SV-Control, action groups and actions can be created, edited and deleted in the “Actions” tab (1). Both profiles (Administrator / User) can be assigned full access rights for this tab. The Smart Visu Server supports up to 25 action groups and 250 actions.

The “Actions”, “Action Settings” (2, 4, 5) and the actions group “all actions” tabs can be hidden or renamed (3) for SV-Home.

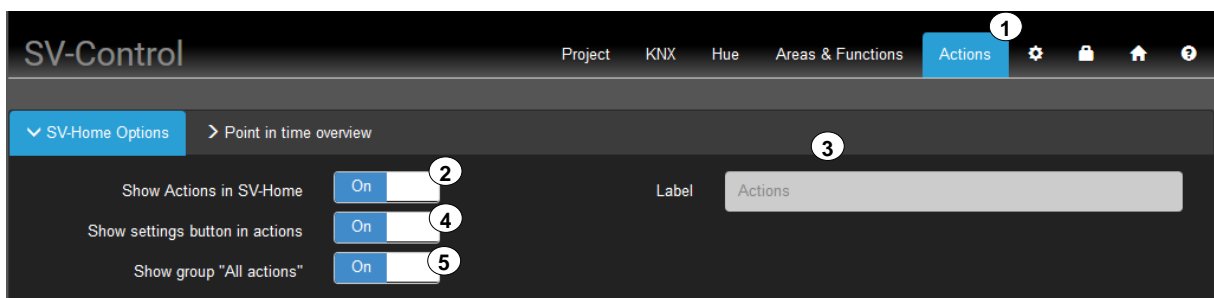


Figure 85: Renaming / Hiding SV-Control “Actions” tab

2.6.1 Creating action groups

To create a new action group, enter the name of your new group in the input field (1) and then press the “+” button. It will be added to the action group list (4) and is selected automatically.

The action group selected in the list (3) is displayed for editing in the column “Edit group” (4). Pressing the currently selected icon “⊙” (5) allows an alternative icon from the library to be assigned to the action group and the action name can be edited in the input field (6).

Optionally you can activate or deactivate (7) the action group.

With “Activation” (8), you can define how the action group should be triggered.

The following options are available:

- Points in time
 - Activation and deactivation by date and time
 - Repetitions: annually or none
- Event
 - Trigger by 1-bit object (e. g. Push-Button (Welcome / Goodbye))
- Manually
 - Trigger via SV-Control

If an action group is required again, it can be duplicated including all actions (9).

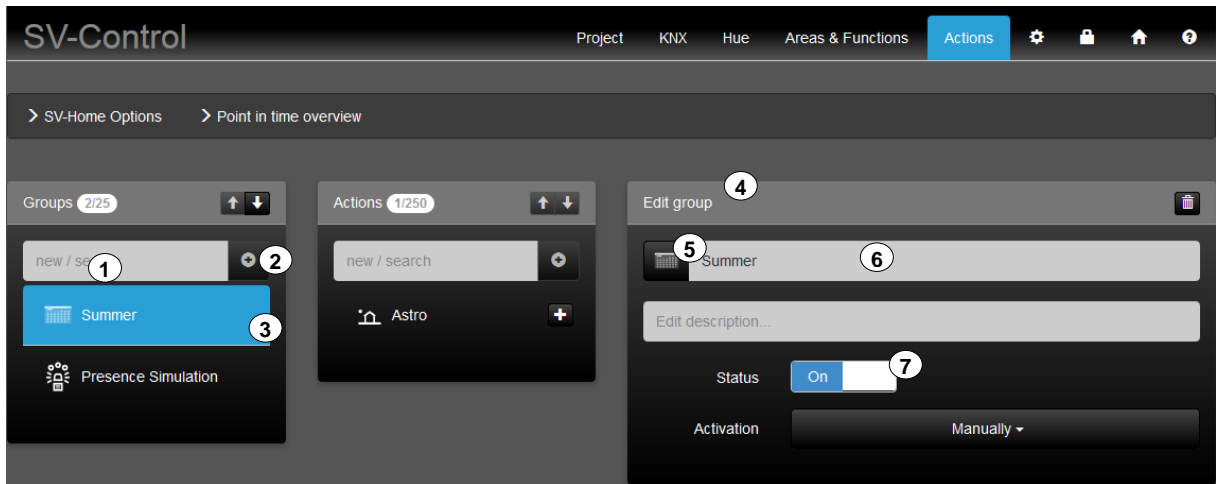


Figure 86: SV-Control “Action” tab

2.6.1.1 Points in time

Activation type “Points in time” can be used to activate and deactivate action groups based on date and time. Use the calendar to set the date and then the time for activation (8a) and deactivation (8b). Furthermore, an annual repetition (8c) can be set.

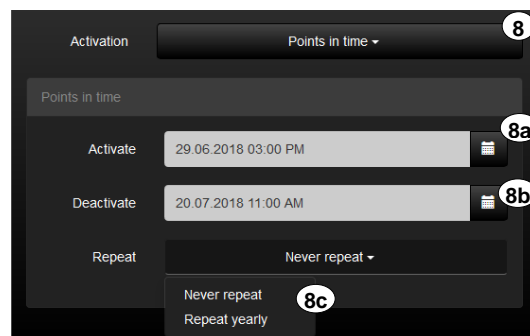


Figure 87: Parameters for activation type “Points in time”

2.6.1.2 Event

With the activation type (8) “Event”, the group can be triggered by a 1-bit object (8a). It can be selected whether the group is activated with “while trigger is ON” or “while trigger is OFF” (8b).

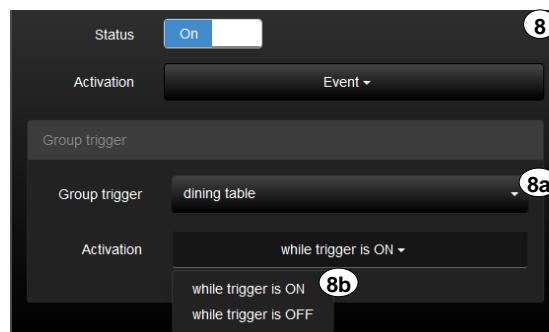


Figure 88: Parameters for activation type “Event”

2.6.1.3 Manually

With the activation type "Manually" (8), the group can be activated manually in the SV-Home.

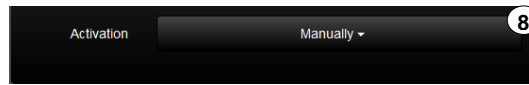


Figure 89: Parameters for activation type “Manually”

IMPORTANT: Actions assigned only in inactive action groups will not be executed.

2.6.2 Creating an action

To create a new action, enter the name of your new action in the input field (2) and then press the "+" button (3). This is added to the action list (4) with its name and is selected automatically.

The action selected in the list (4) is displayed for editing in the column "Edit action" (5). Pressing the currently selected icon "🏠" (6) allows an alternative icon from the library to be assigned to the action and then the action name can be edited in the input field (7).

Optionally, and independently of the action time, you can carry out an area assignment (8), in order to trigger the action in SV-Home for an additional area.

A distinction must be made between three action types using the trigger criteria. The following types are available in the drop-down menu (9):

- Point in time:
 - Trigger via SV-Home
 - Trigger via time and day
- Event:
 - Trigger via SV-Home
 - Trigger via function event
- Astro:
 - Trigger via SV-Home
 - Trigger via sunrise or sunset
- User-defined:
 - Trigger via SV-Home

In the drop-down menu (10), you can specify up to 16 functions with editable function values for each action, which are to be executed when a trigger event occurs. In so doing, a function can also be a higher-level group address (e.g. central function of the KNX system).

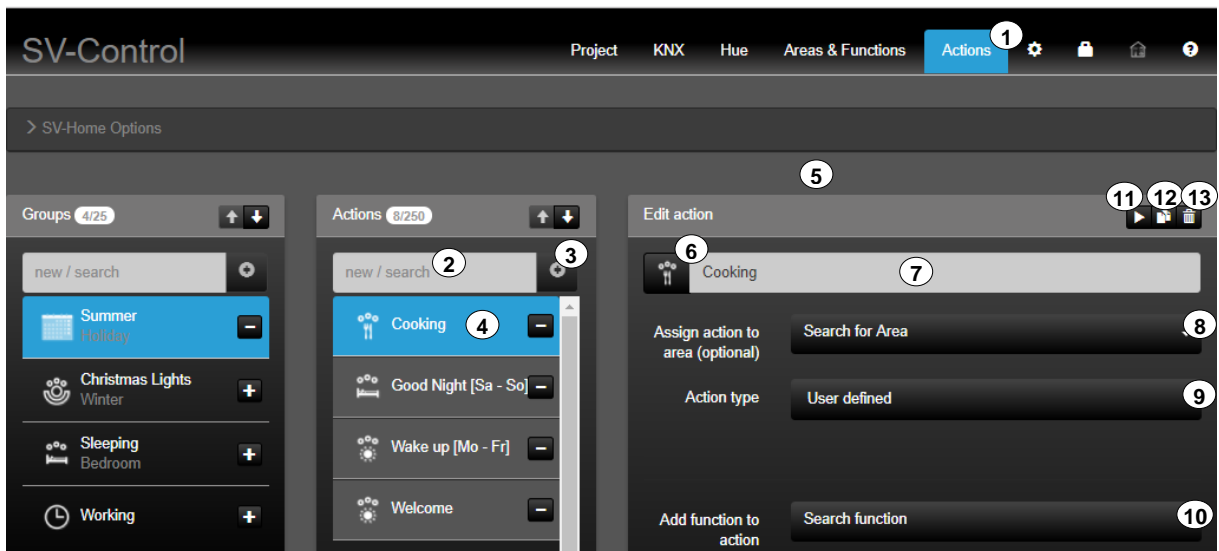


Figure 90: "Actions" tab

Each function assigned to the selected action is listed beneath the drop-down menu (10) in a function list (10a). The parameters (10b) of each function can be set separately. Various operating elements are available, depending on the function type. These correspond to the elementary operating elements of the appropriate function in SV-Home.

Using the "▶" icon (10c), you can execute the set function value (10b). The representation of the function may differ between SV-Home and SV-Control (e.g. shutter button). If a function is to be deleted from the action list, you can trigger this with the "🗑️" icon (10d).

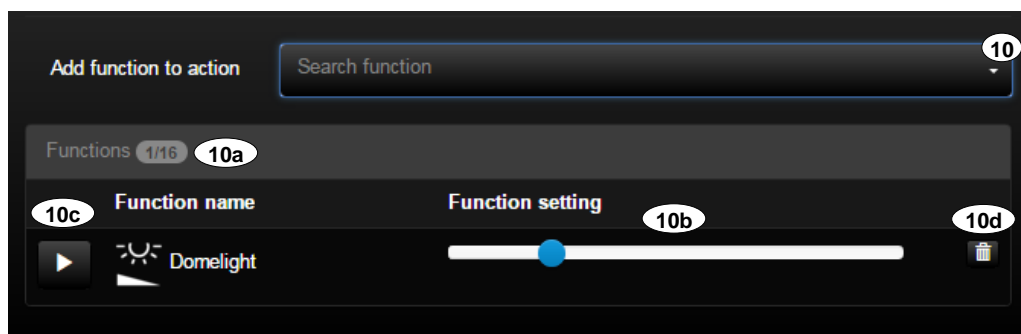


Figure 91: Parameters of the function to be executed

The changes are automatically saved and briefly displayed by a green "Save successful" screen. It can be tested directly from SV-Control with the "▶" icon (11).

2.6.2.1 Point in time

"Point in time" action types (9) trigger automatically, depending on the weekday and the set time. In addition, you can trigger this action type individually via SV-Home.

The button (9a) opens the window to set the time. Set the trigger time using the arrows "⬆️" (9b).

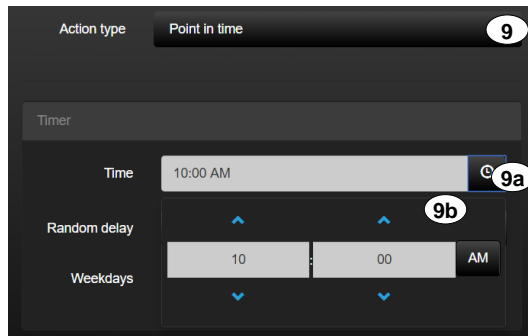


Figure 92: Parameters of the "Point in Time" action type

Alongside that, you can specify the weekdays (9c) on which the action is executed. Active days have a blue background.

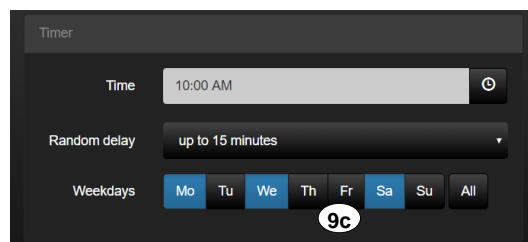


Figure 93: Parameters of the "Point in Time" action type

In addition to the set time and the day of the week, a random delay can be activated. The action triggers randomly within the selected period (9d).

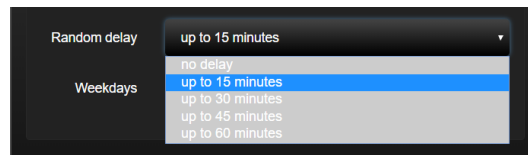


Figure 94: Random delay of the "Point in Time" action type

2.6.2.2 Event

Actions of type "Event" (9) can be triggered by a function event (e.g. pressing a KNX pushbutton sensor) selectable in the menu (9a). The function state leading to the triggering of the action can be selected using the selection menu (9b). You can only select functions that contain at least one 1-bit data point (for example, results of the "State Logic" function). After selecting the trigger, the significance of the condition must be determined. The following options are available:

- At state On (state change necessary to re-initiate action, e.g. wind alarm)
- At state Off (change of state necessary to trigger action again)
- At state change (state change between on and off)
- At each On (no state change required to re-trigger action, e.g. button)
- On each Off (no state change needed to re-trigger action)

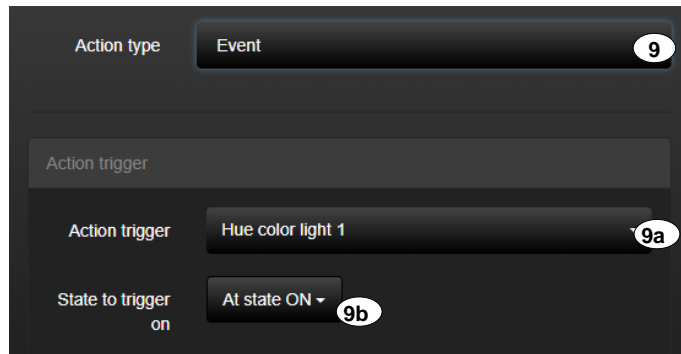


Figure 95: Parameters of the "Event" action type

2.6.2.3 Astro

The action type "Astro" (9) automatically triggers functions depending on the position of the sun. As a trigger (9a), the sunrise or sunset can be selected. The time (9b) for today's sunrise or sunset is shown on the right. With the offset (9c), the triggering period can be adjusted in time. You can set the days of the week (9d) on which the action will be performed. Active days are highlighted in blue. In addition, an earliest or latest time can be defined (9e).

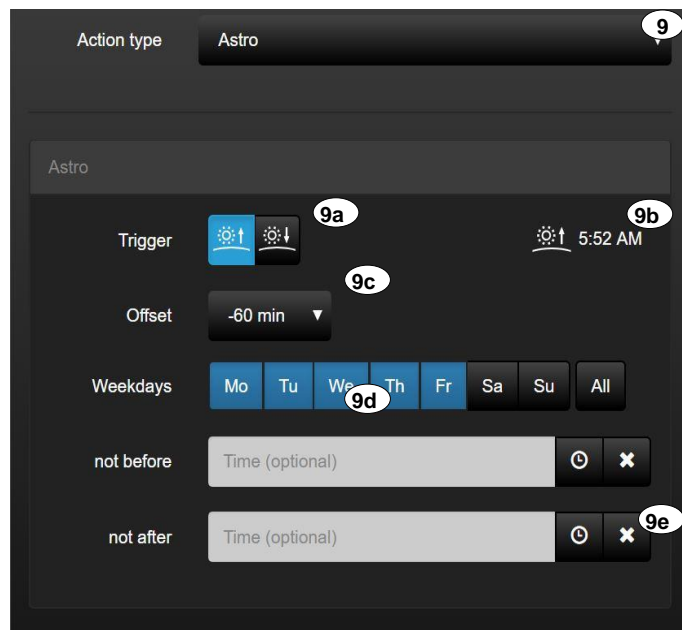


Figure 96: Parameters for the "Astro" action type

The Astro function can be used both with a local and NTP time.

2.6.2.4 User defined

Actions of type "User defined" (9) are actions, which can only be triggered manually via SV-Home. For this reason, this action type does not require any additional configuration.



Figure 97: Parameters of the "User defined" action type

2.6.3 Editing or deleting an action

To be able to edit or delete an action, you must first select it in the "Actions" list (1). The action selected in the list (1) is displayed for editing in the column "Edit action" (2).

A selected action can be deleted with the "🗑️" icon (3). You can execute the action conveniently directly from SV-Control using the "▶️" icon (4).

An action can be copied with the "📄" icon (5). The copy function causes the creation of a new additional action with the same configuration.

The changes are automatically saved and briefly displayed by a green "Save successful" screen.

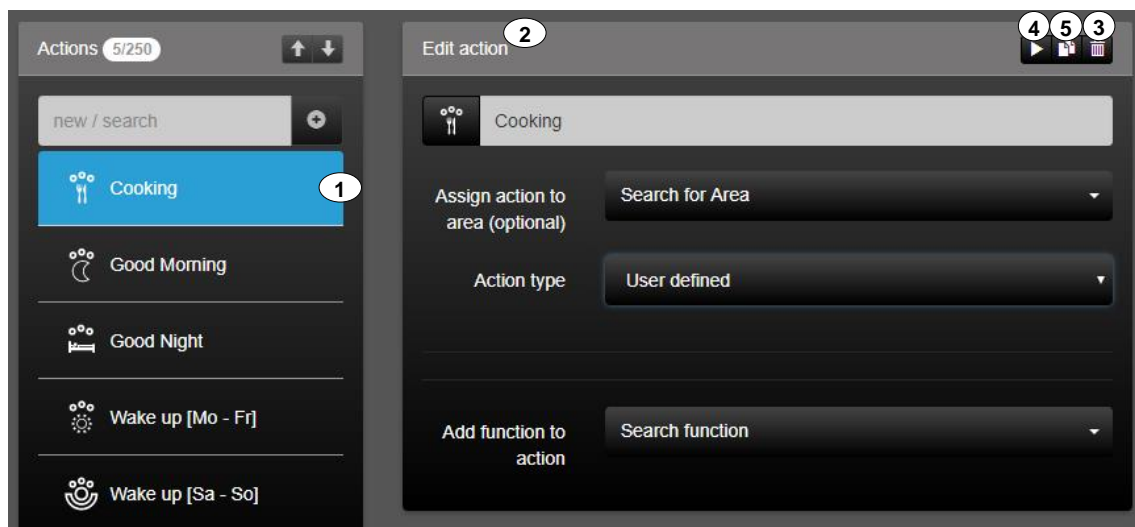
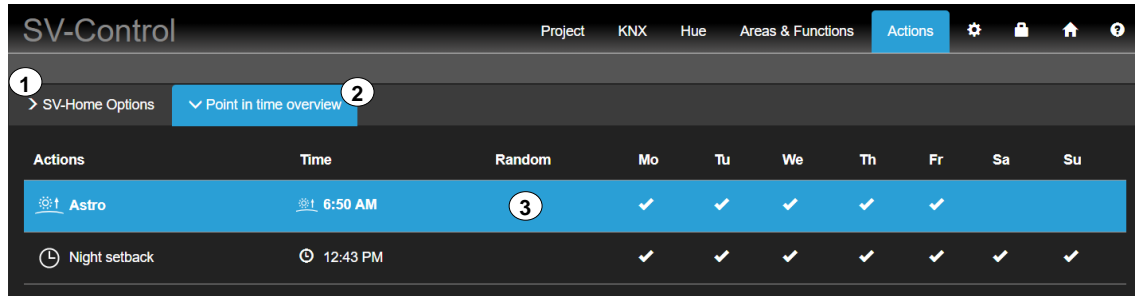


Figure 98: "Actions" tab

2.6.4 Point in time overview of the actions

In the area SV-Home Options (1), “Point in time overview” (2) - a list of the actions with the respective time switching points - can be displayed. The currently selected action is highlighted in blue (3) in this overview.

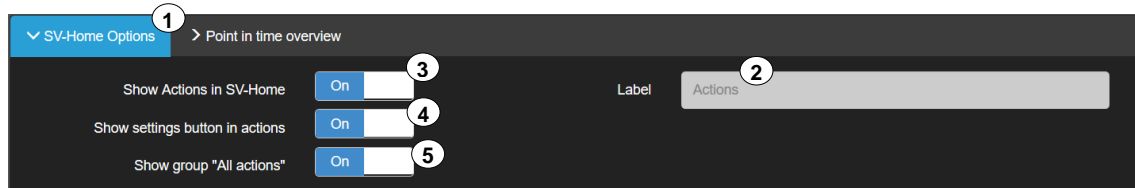


Actions	Time	Random	Mo	Tu	We	Th	Fr	Sa	Su
Astro	6:50 AM	(3)	✓	✓	✓	✓	✓		
Night setback	12:43 PM		✓	✓	✓	✓	✓	✓	✓

Figure 99: Point in time overview

2.6.5 SV-Home Options

In the area SV-Home Options (1), actions in SV-Home are displayed (3) when activated with the defined label (2). It is also possible to select whether there should be a settings button (4) for each action. The action group “All actions” can also be hidden in SV-Home (5).



SV-Home Options (1) > Point in time overview

Show Actions in SV-Home (3)

Show settings button in actions (4)

Show group "All actions" (5)

Label: Actions (2)

Figure 100: Overview of SV-Home Options

2.7 Configuration management

Configuration management is used to set elementary system parameters of the Smart Visu Server. You can change the network settings (2), the time and the current date (3). When using the Astro function (4), the latitude and longitude of the location can be entered. Furthermore, a MyJUNG remote access (5), an email SMTP-Server (6) can be set up and online system updates can be carried out (7) and the update progress can be displayed. In addition, the system (8) is equipped with four main functions.

The configuration management can be reached in SV-Control via the "⚙️" tab (1). The tab can be operated fully with both profiles (Administrator/User).

The screenshot displays the SV-Control configuration interface with the following sections and settings:

- 1. Settings Tab:** Located at the top right of the navigation bar.
- 2. Network settings:** Includes fields for MAC-Address (00:22:d1:02:b0:3e), Mode (DHCP/Static), IP-Address (192.168.1.22), Subnet Mask (255.255.255.0), DNS Server (192.168.1.1), and Gateway (192.168.1.1).
- 3. Time:** Includes Mode (NTP synced/manual), Last Sync (06.09.2018 11:59 AM), Time zone (Etc/UTC), and NTP Server (pool.ntp.org).
- 4. Astro:** Includes Latitude (51.23848) and Longitude (7.54876) fields.
- 5. MyJUNG Remote:** Includes MyJUNG-Username and MyJUNG-Password fields, a Register device button, and a MyJUNG Remote toggle switch (On).
- 6. Email server settings:** Includes Email server (Select predefined email server), Host (smtp.gmail.com), Port (587), Username (maxmustermann@gmail.com), Password (masked), and From (maxmustermann@gmail.com).
- 7. Update:** Includes a Start button and a status indicator (System is ahead).
- 8. System:** Includes Restart, Shutdown, Factory Settings, and LED Signal buttons.

Figure 101: Tab of the Smart Visu Server configuration

2.7.1 Network settings

The network settings can be edited in the "Network Settings" field (2) for the local network (IPv4) in the configuration management of SV-Control. The network settings of the Smart Visu Server can be entered automatically via DHCP address assignment (2a) or manually ("statically") (2b).

2.7.1.1 Configuring the IP address for DHCP

The DHCP address assignment is set as default when the device is delivered.

For the Smart Visu Server to obtain its IP address automatically via DHCP address assignment, the "DHCP" option (2a) must be selected. In this case, the fields 2c to 2f cannot be edited, but are only used to visualise the current, automatically obtained network settings.

To apply the selected setting, the "Apply" button (2g) must then be pressed.



The DHCP setting can be restored at any time through an "IP Reset" using the device Reset button. You can find more information on this in Chapter 1.5 "Structure of the device, function"

2.7.1.2 Setting a static IP address

To manually assign a static address to the Smart Visu Server after commissioning, the item "Static" (2b) must be activated. The input fields (2c to 2f) can then be edited.

To apply the selected setting, the "Apply" button (2g) must then be pressed.

The static IPv4 address can be entered in the input field (2c). The subnet mask of the network can be specified in the input field (2d). You can specify a DNS server in the input field (2e) and an IP Gateway in the input field (2f).

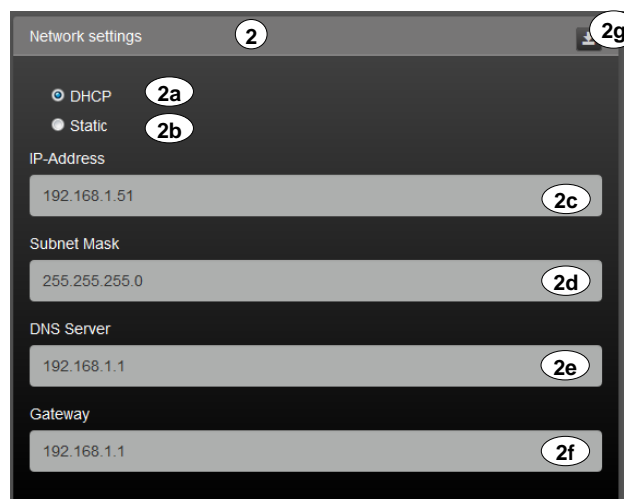


Figure 102: Parameters of the IP interface

2.7.2 Setting the system time and date

The system time and the current date can be edited in the "Time" field (3) in the configuration management of SV-Control. The time synchronization can be performed both by NTP time server and manually.

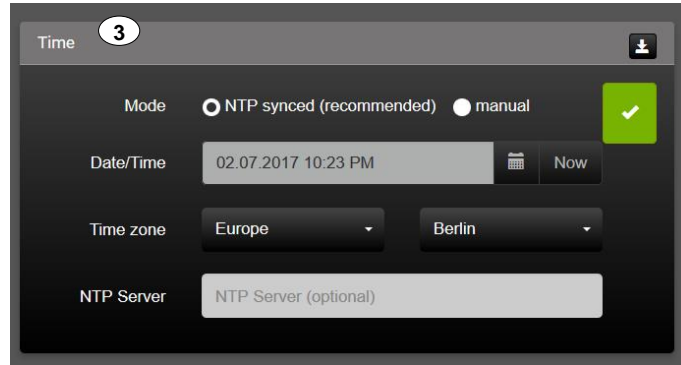


Figure 103: Time server

In the input field (3a), it is possible to enter the current date in the format "dd.mm.yyyy". Alternatively, you can use the "📅" button (3b) at the end of the input field, in order to show a calendar field, to be able to select the current date.

Set the current system time using the arrows "⬆️⬆️" (3c).

To apply the time settings permanently in the Smart Visu Server, you must then press the "⬇️" button (3d).

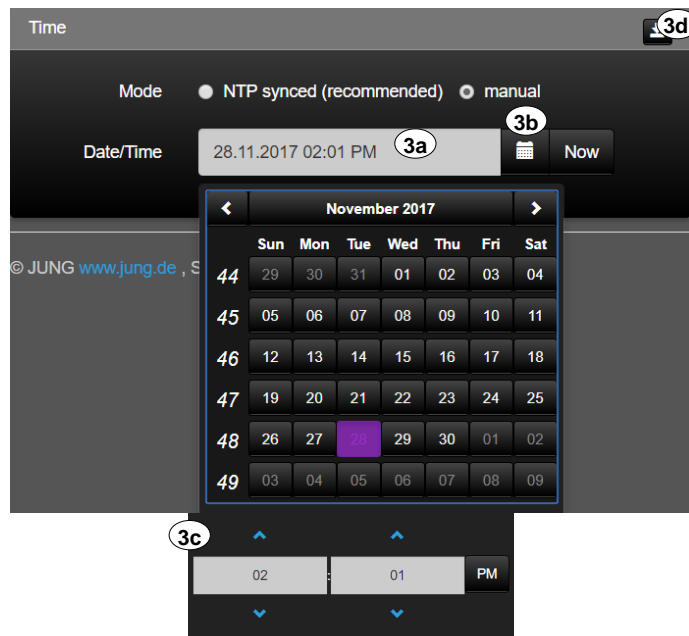


Figure 104: Parameters for setting the time

2.7.3 MyJUNG Konto

With a MyJUNG account, there are further functions available. Firstly, a fee-based remote access facility (**Fehler! Verweisquelle konnte nicht gefunden werden.**) can be set up. Secondly, the Amazon Alexa voice service can be used via the MyJUNG account.

Info: With the creation of a new MyJUNG account, data is not automatically transferred to the Amazon Alexa voice service.

2.7.4 Remote access

The paid remote access allows secure access to the SV-Server. To do this, the switch (1) must be set to "On" and the email address of the MyJung portal must be entered in the field "Remote Username" (2). MyJUNG remote access must then be authenticated via the portal. If a connection is established, a tick appears after "Remote connection" (3).

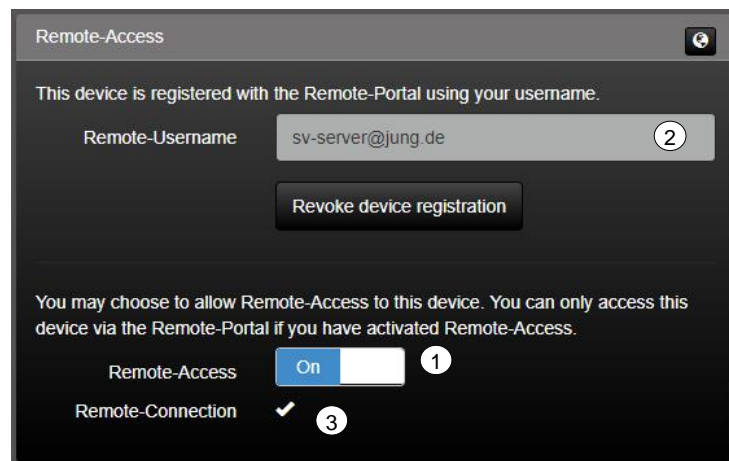


Figure 105: Remote Access

2.7.4.1 Activation of remote access through the MyJung portal

In order to use the secure remote access to the SV-Server, the following steps are necessary:

(1) Application or registration on MyJUNG login

Enter your personal MyJUNG login in the input mask (1). If you do not have a MyJUNG account, follow the input dialog under "[Go to registration](#)" (2).

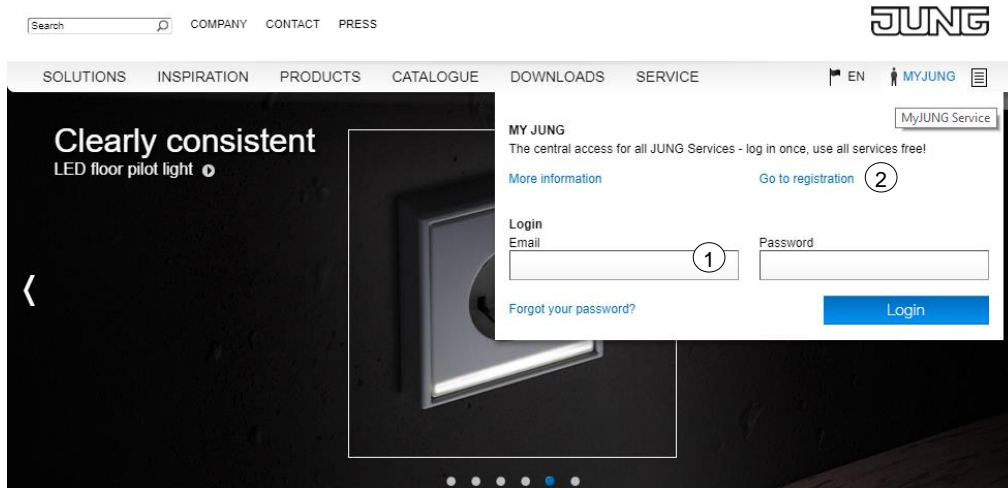


Figure 106: MyJUNG registration dialog

(2) Open Software Licence Sales Dialog

After successful registration in the [MyJUNG portal](#), you will get to the overview page of MyJUNG. On this page, please select the tab "[Software licence activation](#)".

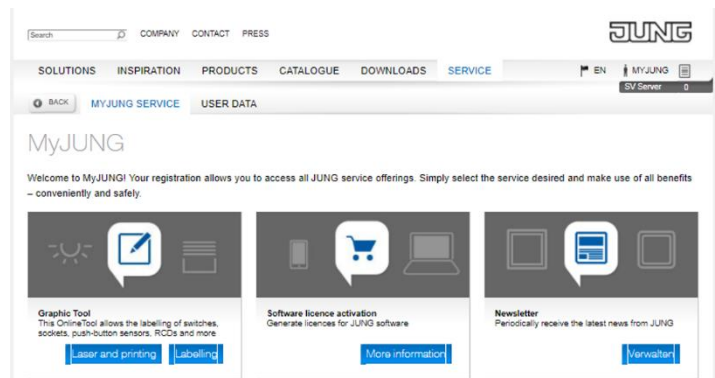


Figure 107: Service overview page of MyJUNG

(3) Selection of the desired product

In this overview you have the opportunity to purchase the desired product. In this case please select from the list on the left-hand side (1) the licence "[Smart Visu Server](#)" (2).

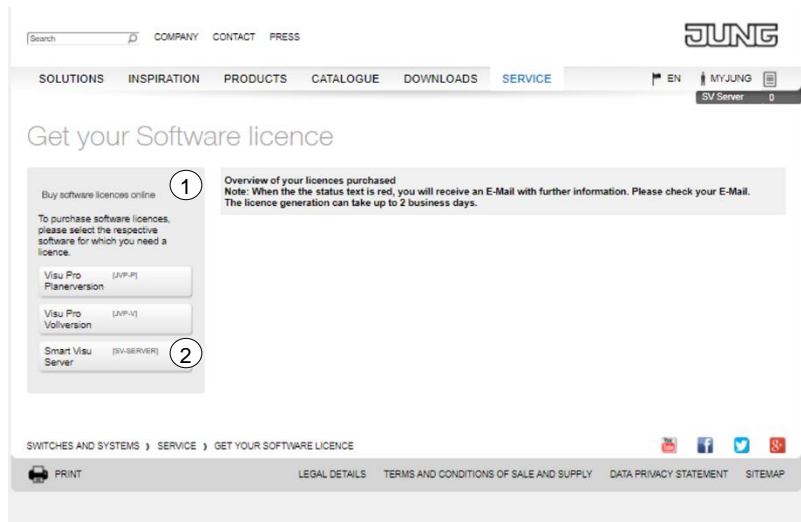


Figure 108: Software licence sales dialogue

(4) Redeem the voucher code or purchase an SV-Server remote subscription

In this view, you have the option to redeem an existing voucher code (over 6 months) or to complete an SV-Server remote subscription over 12 or 24 months. If there is a voucher code, please fill in the field "Voucher code" (1) with your personal voucher code. To complete this action, confirm with "Accept licence data" (2).

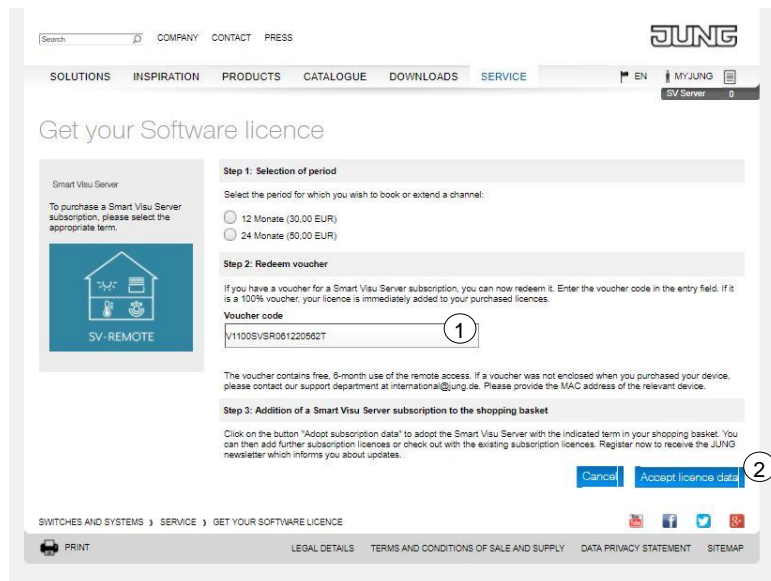


Figure 109: Software licence sales dialogue

If you have successfully redeemed the voucher code or have successfully completed a subscription, you will see the following view.

Search COMPANY CONTACT PRESS

JUNG

SOLUTIONS INSPIRATION PRODUCTS CATALOGUE DOWNLOADS SERVICE EN MYJUNG

SV Server 0

Get your Software licence

Buy software licences online

To purchase software licences, please select the respective software for which you need a licence.

Visu Pro Planversion [ZVP-P]

Visu Pro Vollversion [ZVP-V]

Smart Visu Server [SV-SERVER]

Overview of your licences purchased
Note: When the status text is red, you will receive an E-Mail with further information. Please check your E-Mail. The licence generation can take up to 2 business days.

Smart Visu Server (6 Monate)	2017-12-06	Activation code received	Edit
------------------------------	------------	--------------------------	----------------------

SWITCHES AND SYSTEMS) SERVICE) GET YOUR SOFTWARE LICENCE

PRINT LEGAL DETAILS TERMS AND CONDITIONS OF SALE AND SUPPLY DATA PRIVACY STATEMENT SITEMAP

Figure 110: Successful licence purchase

2.7.4.2 Activation of MyJUNG remote access in your SV-Server

To enable secure remote access to your SV-Server, the following final steps are necessary.

(1) Activation of your MyJUNG account in your SV-Server

Switch to the browser of your operating system. In this case, call up the start page of the SV-Server. To do this, use either "sv-server.local" or the associated **IP address** of your SV-Server. After the surface is loaded, please select [SV-Control](#) (1).

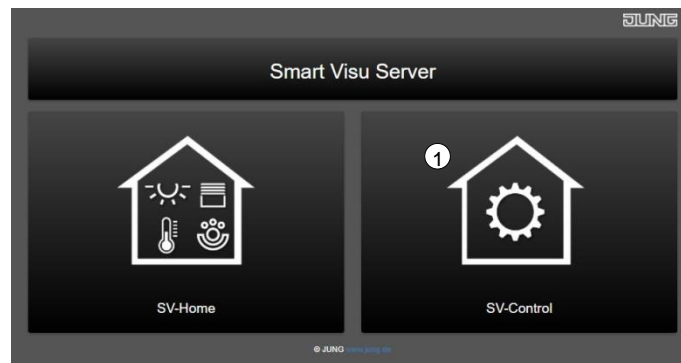


Figure 111: SV-Server start page

Now enter your MyJUNG username (1) and your associated MyJUNG password (2) in the right-hand column, under the heading "MyJUNG access". Then confirm this step with the "Register device" button (3).

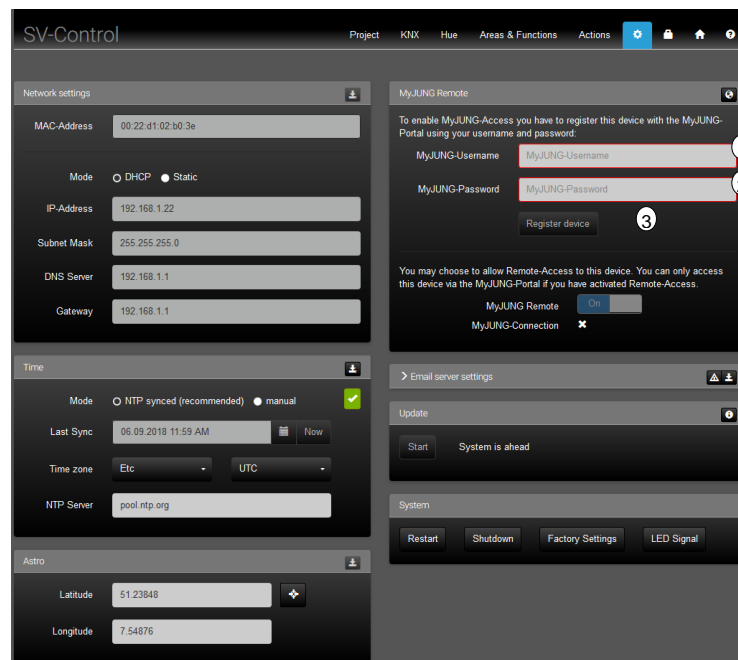


Figure 112: Remote access in the SV-Server

(2) Activation of your SV-Server in your MyJUNG-Portal

At this time, your SV-Server is actively logged into MyJUNG. The remote connection is up-to-date but not usable yet. For final steps, please change to a new browser window or a new browser tab. Log into the [MyJUNG portal](#) on the JUNG website. Switch to the [Smart Visu Server Remote Access](#) tile via the "Manage" button (1).

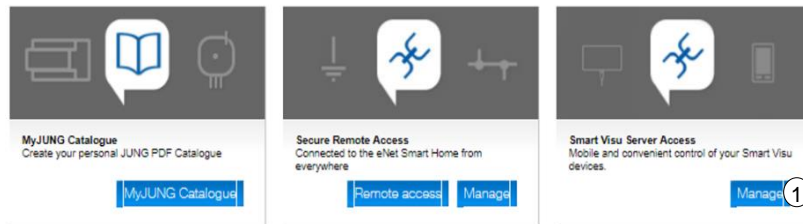


Figure 113: Smart Visu Server remote access

Finally, to activate the remote access, please confirm the process in the displayed view with the button "Activate now" (1). From then on, your configured remote access will work for the specified runtime.

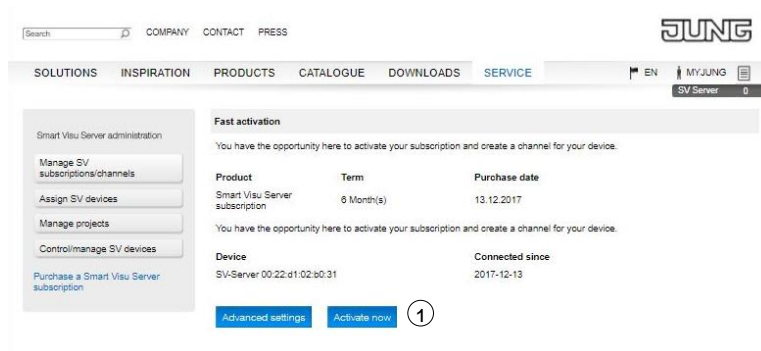


Figure 114: Activation of the remote access

The following overview of the MyJUNG portal provides information about your activated subscriptions. This information includes: item, term, date of purchase, remaining time, project, equipment and channel. This information will help you to manage your [SV-Server Remote Access](#) immediately.

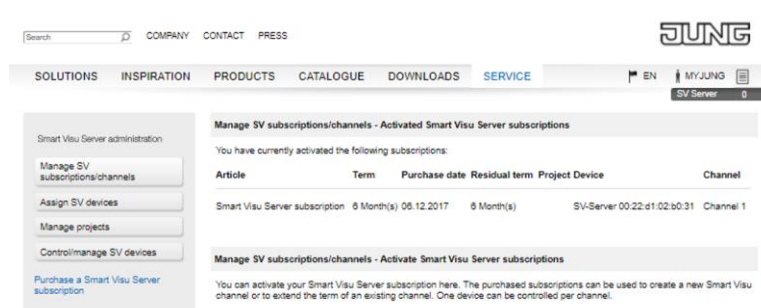


Figure 115: Enabled SV-Server subscriptions

If the connection between your SV-Server and the MyJUNG portal succeeds, the following view will appear in the [SV-Control](#). With the confirmation tick next to “Remote connection” (1), you will see that a successful connection between your SV-Server and the MyJUNG server has been established. To set up the apps, please see the dedicated chapter ([Android 3.2](#) / [iOS 3.3](#)).

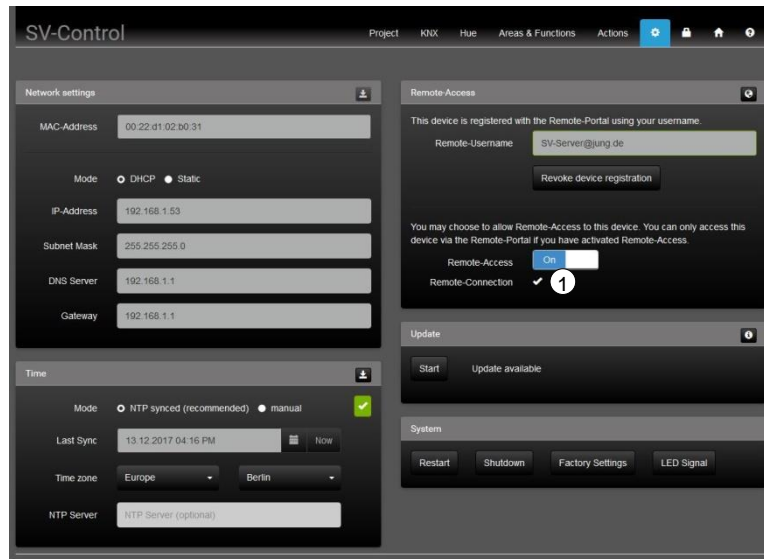


Figure 116: Successfully established remote connection

Alternatively, remote access can also be [controlled / managed](#) (1) via a web browser.(2).

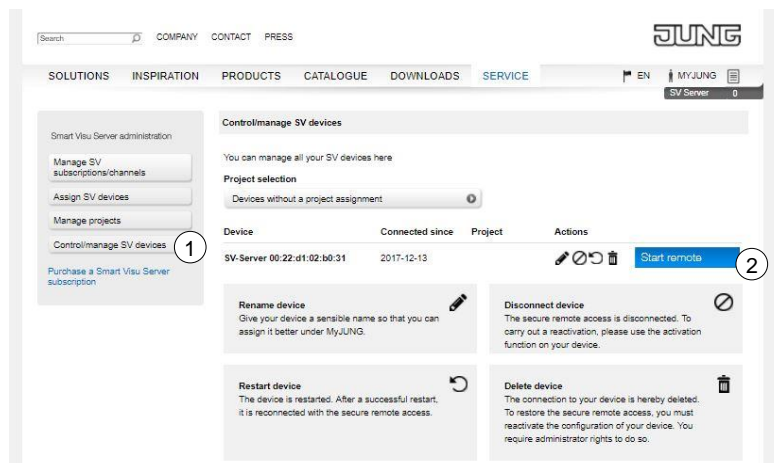


Figure 117: Remote access via web browser

2.7.5 Amazon Alexa

There is the possibility of using the Amazon Alexa voice service through a MyJUNG account. To do so, the MyJUNG account must be activated in the SV-Server as for remote access.

Select the “Settings” tab and enter your MyJUNG user name (1) and your relevant MyJUNG password (2). Then confirm this step with the button “Register device” (3).

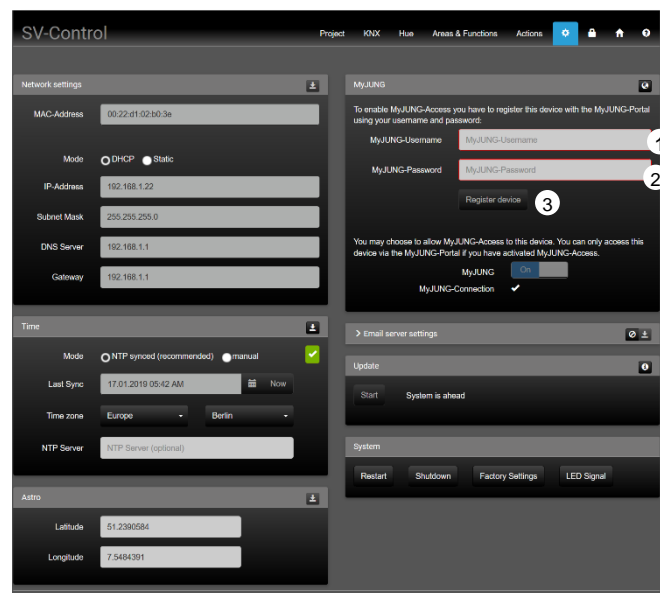


Figure 118: Activation of the MyJUNG account in the SV-Server

The Alexa voice control must in addition be activated (4) under the properties of functions and actions.

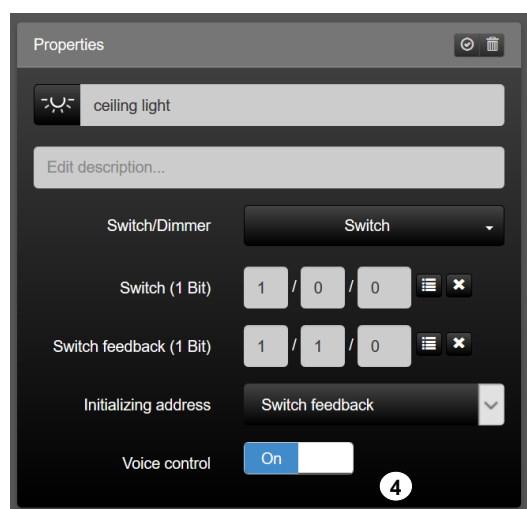


Figure 119: Activation of the voice control in the properties of a function

Please take all further functions from the quick guide.

Info: With the creation of a new MyJUNG account and the activation of the voice control in the properties of the functions, data is not automatically transferred to the Amazon Alexa voice service.

2.7.6 Email message

Basic settings are necessary for the “Email message” function (1) to guarantee the function. The email server (2) must first be selected so that the host address (3) must be entered automatically.

The following email providers are supplied as favourites in the default state:

Mail	DE	EN	FR	NL	IT	ES	PORT	RU	EST	LIT	LET	POL	UKR	KOR	CHN
Google	✓	✓	✓	✓	✓	✓	✓	✓	✓	✓	✓	-	✓	✓	-
Outlook	-	✓	✓	✓	✓	✓	✓	-	-	-	-	-	✓	-	-
iCloud	-	✓	-	✓	-	✓	✓	-	-	-	-	-	✓	-	-
GMX	✓	-	-	-	-	-	-	-	-	-	-	-	-	-	-
Web	✓	-	-	-	-	-	-	-	-	-	-	-	-	-	-
Orange	-	-	✓	-	-	-	-	-	-	-	-	-	-	-	-
Libero	-	-	-	-	✓	-	-	-	-	-	-	-	-	-	-
Mail	-	-	-	-	-	-	-	✓	✓	✓	✓	-	-	-	-
Yandex	-	-	-	-	-	-	-	✓	-	-	-	-	-	-	-
Yahoo	-	-	-	-	-	-	-	-	✓	✓	✓	-	-	-	-
Home	-	-	-	-	-	-	-	-	-	-	-	-	-	-	-
Nazwa	-	-	-	-	-	-	-	-	-	-	-	✓	-	-	-
IDhosting	-	-	-	-	-	-	-	-	-	-	-	✓	-	-	-
Naver	-	-	-	-	-	-	-	-	-	-	-	✓	-	✓	-
Daun	-	-	-	-	-	-	-	-	-	-	-	-	-	✓	-
EtaEase	-	-	-	-	-	-	-	-	-	-	-	-	-	-	✓
Sina	-	-	-	-	-	-	-	-	-	-	-	-	-	-	✓
Tencent	-	-	-	-	-	-	-	-	-	-	-	-	-	-	✓

Additional providers can be inserted with “More”.

The required port number (4) can be looked up in the settings of the email provider. The email address and the password can be entered in the fields of user name (5) and password (6). The sender (identical to the username in the default case) can be stored under (7).

The settings must finally be stored “” (8).

Figure 120: Settings of the function “Email message”

2.7.7 Server update

To perform a system update, the Smart Visu Server requires access to the Internet. Depending on the speed of the available Internet connection, this operation can take several minutes.

We recommend not interrupting the power and network connection for the period of the update. In addition, we do not recommend making any changes in SV-Control during execution.

A system update, if available, can be started in the "Update" field (4) using the "Start" button (4b). Via button (4a) the release notes are recalled.

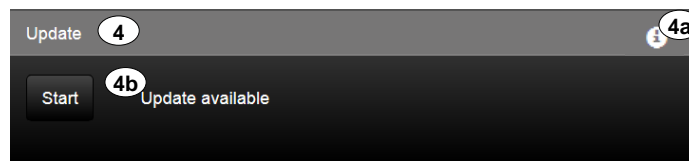


Figure 121: Update window

The progress bar (4c) shows the overall progress of a running update operation. The LED of the device flashes periodically in magenta whilst the update is being performed.

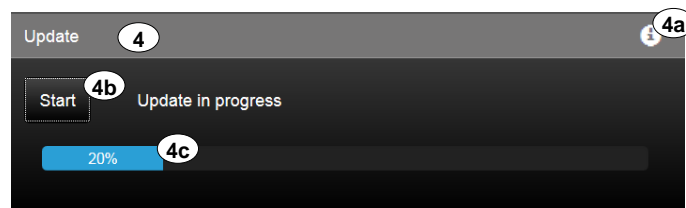


Figure 122: Depiction of an active update

After the update has been downloaded, the system is restarted. During the system restart, a countdown (4d) is displayed. Soon after this reaches 0, you can operate SV-Control as normal. This means that the update operation is complete.

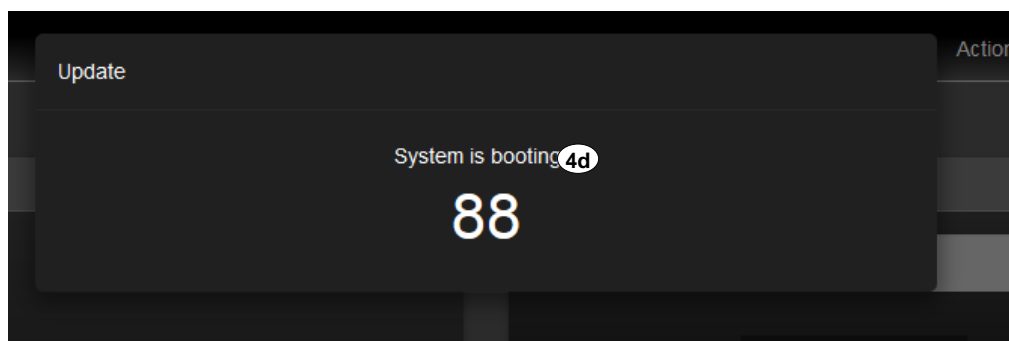


Figure 123: Completing the update

3 SV-Home

This chapter describes the operation of the Smart Visu Server using SV-Home in detail.

The SV-Home is the integrated web interface of the Smart Visu Server for the visualisation, status display and operation of the KNX system and the Philips Hue system. To access SV-Home, a current HTML5-capable browser (input device) or the corresponding app (see chapter 3.2 SV-Server app) is required for mobile devices. The access of max. 10 different clients on the SV-Home web interface is recommended. The SV-Home is generated automatically from the configuration set up in SV-Control and is divided up into three sections.

The top section is always visible and consists of the Jung logo and the title "SV-Home" (1). Clicking the "SV-Home" header (1) takes you back to the homepage, via which you can switch to SV-Control at any time.

The second section (2) displays the areas created in SV-Control with their assigned icon and name alongside each other. If you have created actions in SV-Control, an additional tile "Actions" is added automatically to the right of the areas. The Action tile lists all the actions created in SV-Control and they can be triggered individually here.

Selecting an area displays the assigned functions and actions (3) beneath. Each function is displayed in a separate box with its operating elements. These operating elements may vary, depending on the function type. Refer to Chapter **Fehler! Verweisquelle konnte nicht gefunden werden.** "Creating a new function" to discover which function type leads to which visualisation in SV-Home.

If the value of a function changes, then the visualisation is adapted automatically in SV-Home. If, for example, the ceiling luminaire (4) is switched on via a KNX wall sensor, then the new dimming value (5) is updated automatically in SV-Home.



Figure 124: SV-Home

Areas and possible Action tile

Functions / actions

3.1 SV-Home settings

In addition to the operation of the SV-Home, there are some settings which can be set in the upper section to the left of the label "SV-Home" (1).

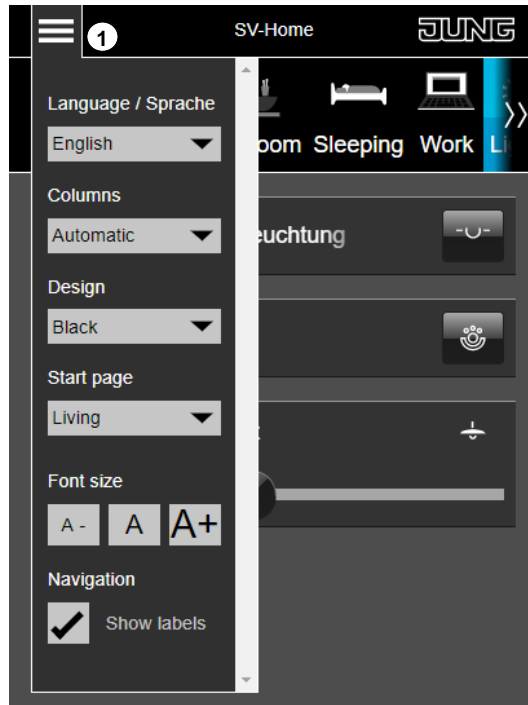


Figure 125: SV-Home settings

3.1.1 Language

In the "Language / Sprache" window (2), 15 different languages can be selected. This changes the language in the SV-Home Settings area. Thus the further settings can be made in the desired language.

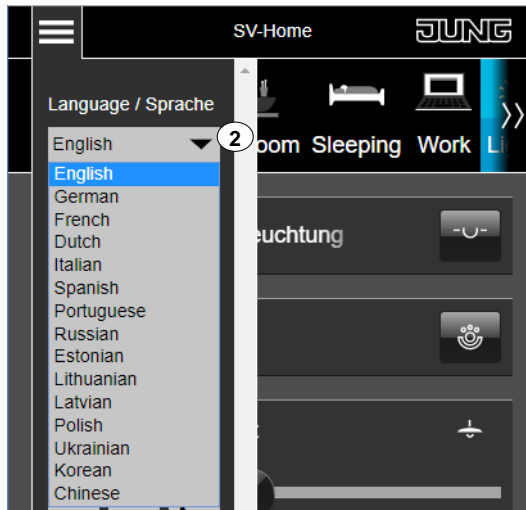


Figure 126: Language

3.1.2 Columns setting

The column settings (1) can be made in the second window. Four setting options (2) are available, which specify the number of columns in the SV-Home (3). The default is the automatic setting of the columns (4). Depending on the page size, the number of columns is automatically scaled and adjusted.

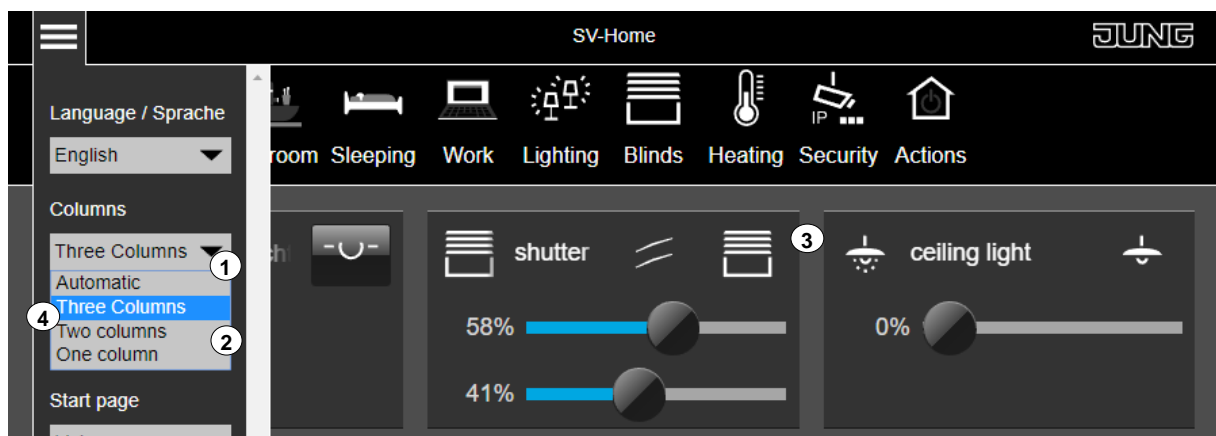


Figure 127: Columns setting

3.1.3 Design

The SV-Home interface can be visualised in two different design variants. The variants can be set under the "Design" window (1). After selecting the desired design, the display is switched directly (2,3).

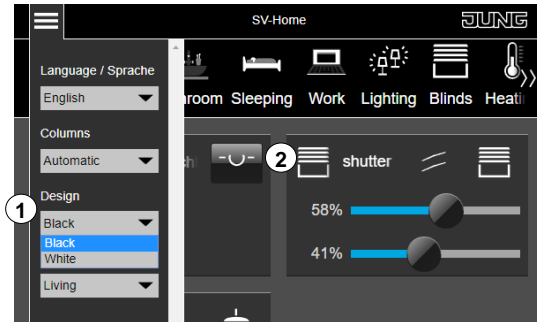


Figure 128: Design "black"

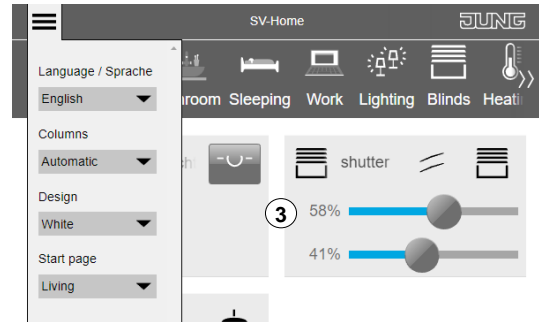


Figure 129: Design "white"

3.1.4 Start page

The setting of the start page, which is displayed if the SV-Home page is opened, can be changed in the "Home" window (1). All created rooms (2) are available.

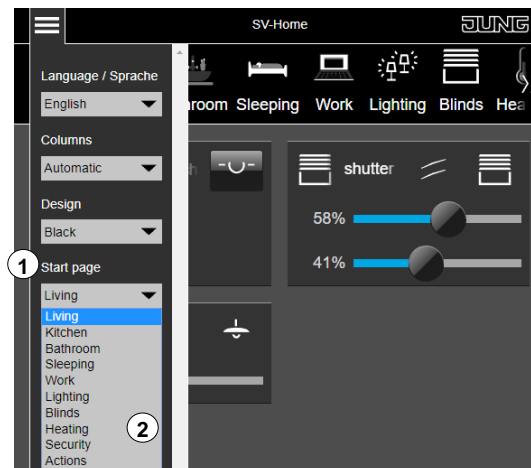


Figure 130: Start page

3.1.5 Font size

The font size is individually adjustable in the SV-Home. Using the button (2), the font size can be reduced and the button (3) can be enlarged. To return to the default font size, the button (4) is provided. The changes are immediately recognisable.

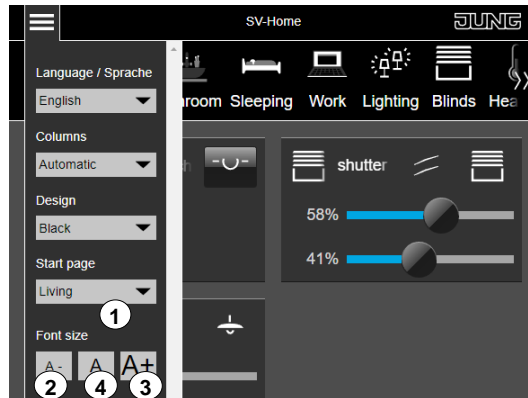


Figure 131: Font size

3.1.6 Presentation labels

In this area "Navigation" (1) it is possible to adjust whether the labels are to be displayed in the area bar (2). By removing the tick, only the symbols (3) without labels are displayed.

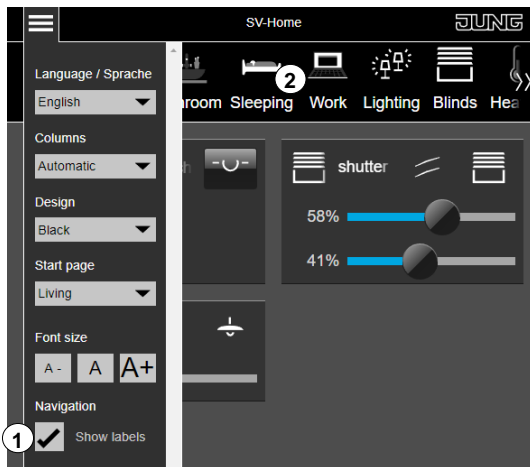


Figure 132: Presentation with labels

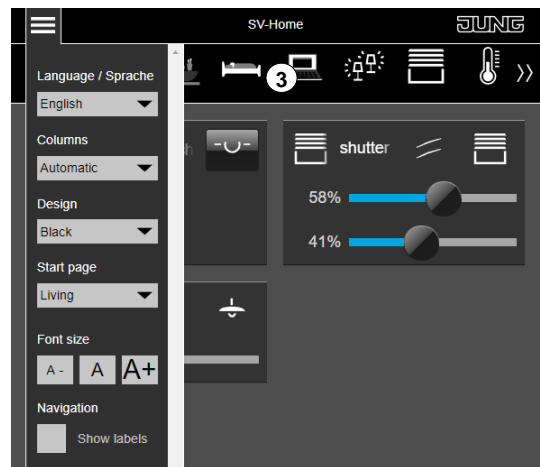


Figure 133: Presentation without labels

3.2 SV-Server app for Android

In addition to the HTML5 surface, you can download the Smart Visu Server app from the Android PlayStore. The Android app is pre-installed on the JUNG Smart Controls (Smart Control 7 .. 19).

Clicking on the gearwheel icon (1) shows the settings for the app. The IP address of the Smart Visu Server with the addition '/SV-Home/' needs to be saved in the settings (2).

Changes of the user interface or limitations of the device may require emptying of the system cache (3). By entering the MyJUNG data (4), the remote access is established. The connection mode (5) can be used to select whether the connection is "Automatic", "Local only" or "Remote only". The app can start automatically after the system start (6) and the screen orientation can be defined (7), which is especially useful for built-in devices.

The navigation bar at the bottom of the JUNG Launcher (Smart Control 7 .. 19) can be hidden and replaced by a control sidebar (8).

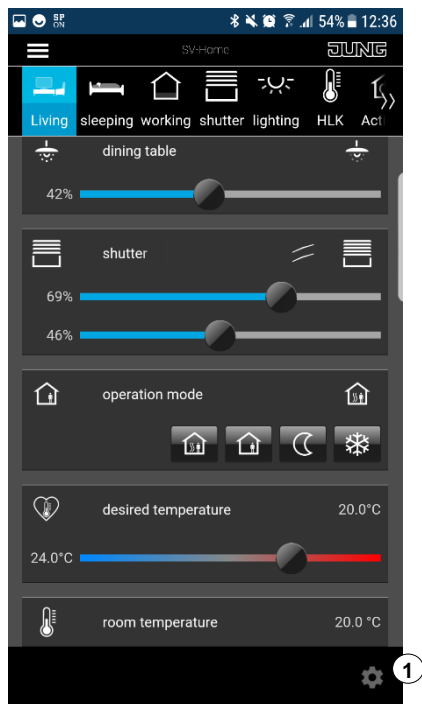


Figure 134: SV-Home

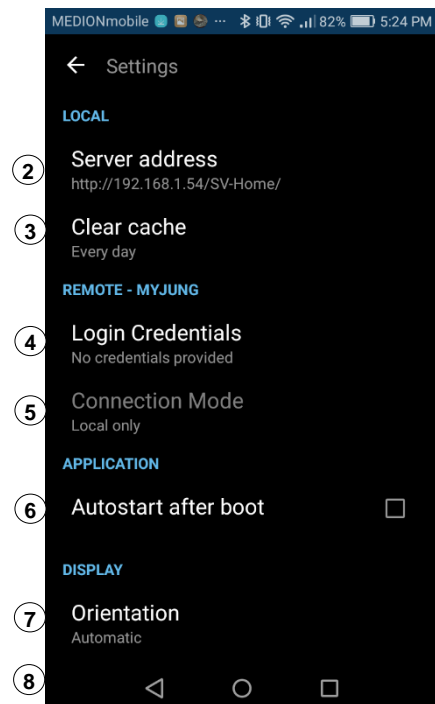


Figure 135: SV-Home

3.3 SV-Server app for iOS

In addition to the HTML5 surface, you can download the Smart Visu Server app from the iTunes Store.

When starting the app for the first time, the connection mode (1) must be selected and the server address (2) must be entered. Finally confirm with OK.

SV-Overview (3) contains the user interface. Further information can be found under Support (4).

By pressing the gearwheel icon (5), app settings are visible. Within these settings, the IP address of your Smart Visu Server can be stored and changed (6).

Changes to the user interface or limitation of the terminal may cause it to empty its system cache (7).

By entering the MyJUNG data (8), the remote access is established. The connection mode (9) can be used to select whether the connection is "Automatic", "Local only" or "Remote only".

In the "Automatic" mode, an attempt is made at the beginning to reach an SV-Server at the entered URL. If it fails, the connection is made remotely.

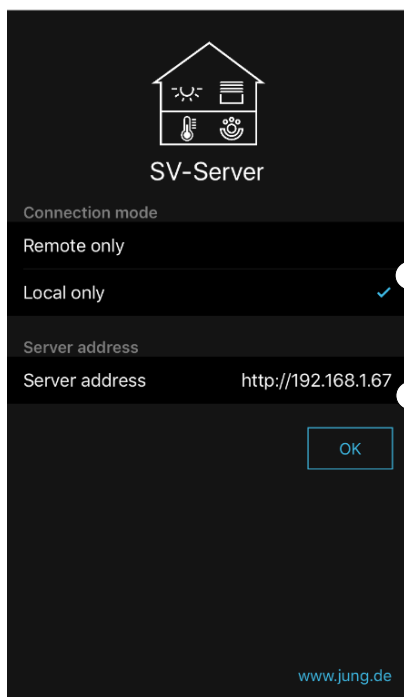


Figure 136: SV-Server app start

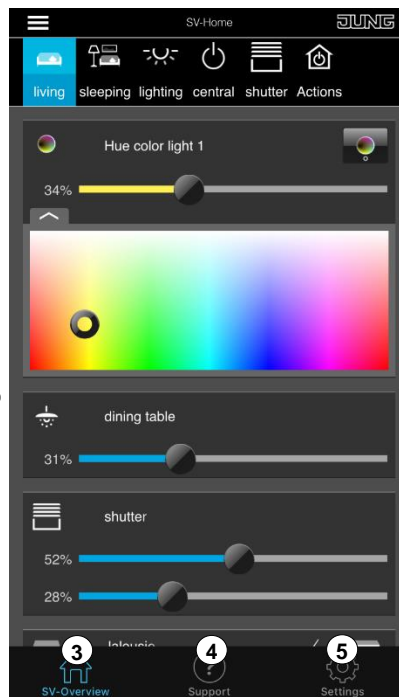


Figure 137: SV-Home

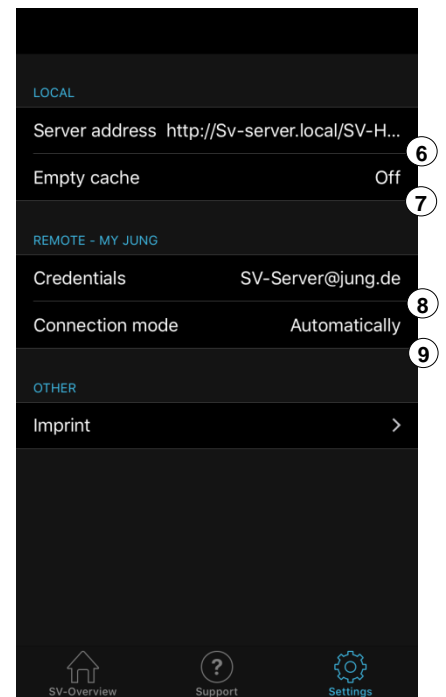


Figure 138: SV settings

4 Update of the Smart Visu Server

JUNG is always working to improve the support and functionality of the SV-Server. In the context of these efforts, we make updates for the system software available.

4.1 Reading out the software version

You can read out the software version currently installed on your Smart Visu Server via SV-Control. This is shown at the bottom of all the tabs of SV-Control behind the text "SW VERSION:" (1).

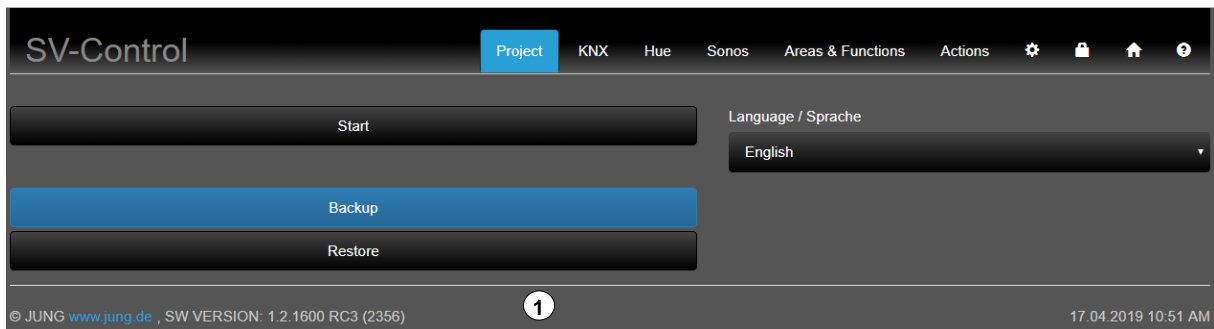


Figure 139: Homepage of SV-Control

4.2 Performing a system update

To perform a system update, the Smart Visu Server requires access to the Internet. Depending on the speed of the available Internet connection, this operation can take several minutes.

We recommend not interrupting the power and network connection for the period of the update. In addition, we do not recommend making any changes in SV-Control during execution. The Status LED (5) of the device flashes periodically in magenta whilst the update is being performed.

A system update can be triggered both via SV-Control (see Chapter 2.7.7 Server update) and via the pushbutton (4) of the Smart Visu Server.

In addition, it is possible to import a server update via a USB stick. For the corresponding manual steps, please refer to the separate instructions on our website.

To perform the system update using the pushbutton (5) on the device, press the button 5 times quickly in succession. If an update is available, this is then downloaded automatically and installed. When the update has been completed, the Smart Visu Server restarts automatically. (<https://www.jung.de/en/>)

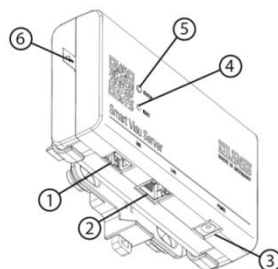
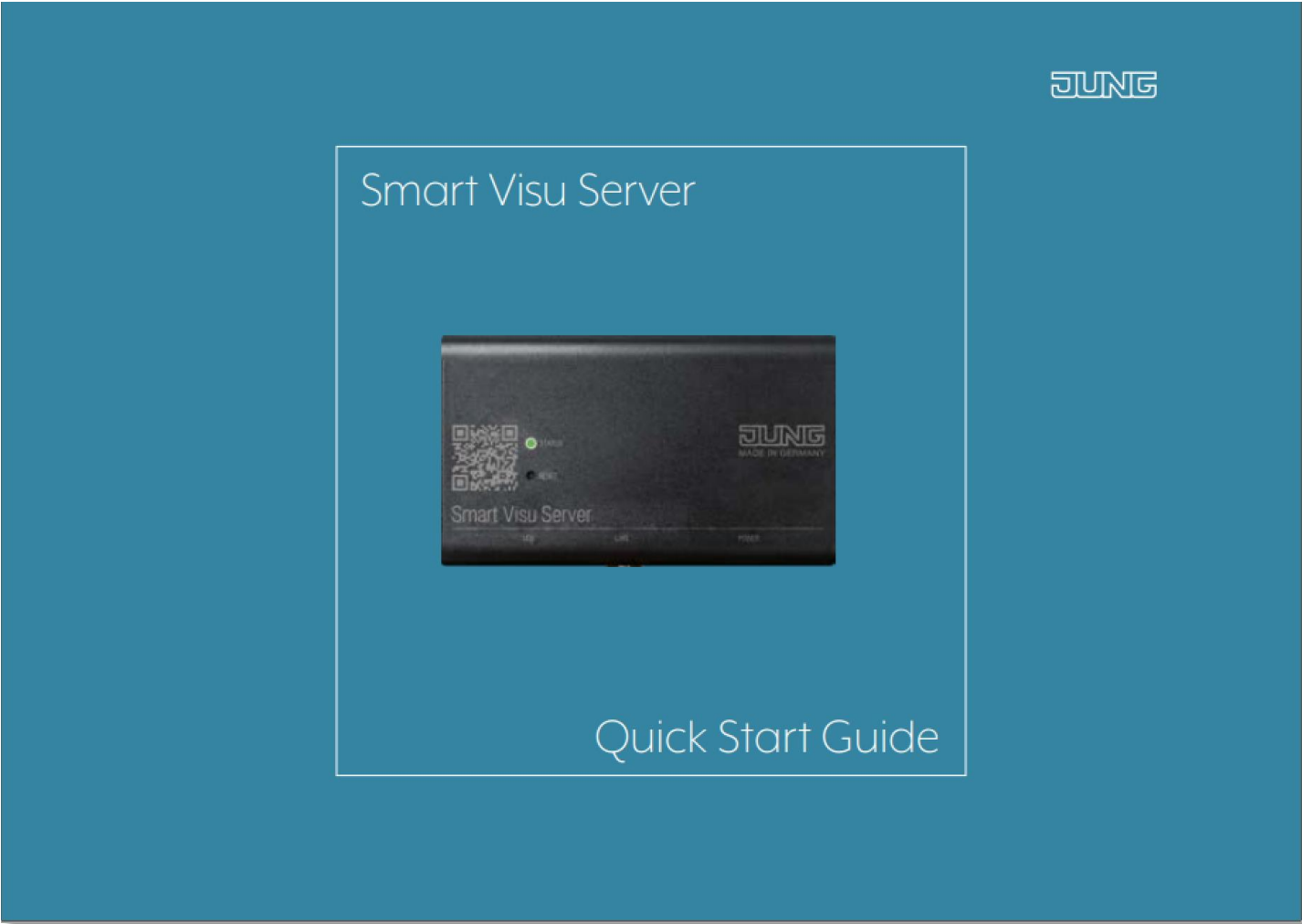


Figure 140: Smart Visu Server

5 Application examples



6 Maintaining the Smart Visu Server

In case you need support, the Smart Visu Server allows remote maintenance access via SSH server. This server is exclusively for fault analysis purposes. It allows trained JUNG personnel to access your server to analyse the device status.

To minimize any possible security risks, the remote maintenance access works only in combination with physical access to the device. You can activate the access by pressing the button (4) 10 times. The SSH access will automatically be deactivated after 2 hours.

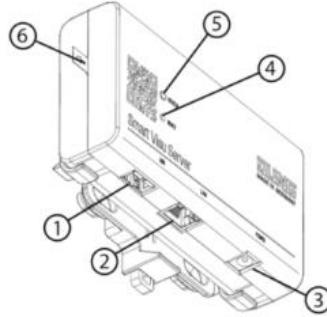


Figure 141: Smart Visu Server

7 Appendix

7.1 Accessories

We recommend using one of the following KNX-IP data interfaces:

- Jung: KNX IP interface, ref. no.: IPS 300 SREG
- Jung: KNX IP router, ref. no.: IPR 300 SREG

8 Copyright

This product incorporates open source software components covered by the terms of third-party copyright notices and licence agreements contained below.

GNU Linux 4.1.15 armv7l

- Copyright (C) 1989, 1991 Free Software Foundation, Inc. 51 Franklin St, Fifth Floor, Boston, MA 02110-1301, USA
GNU GENERAL PUBLIC LICENCE Version 2: <http://www.gnu.org/licenses/gpl-2.0.txt>

Debian 9 “Stretch”

- Copyright (C) 1989, 1991 Free Software Foundation, Inc. 51 Franklin St, Fifth Floor, Boston, MA 02110-1301, USA
GNU GENERAL PUBLIC LICENCE Version 2: <http://www.gnu.org/licenses/gpl-2.0.txt>
- <http://fsf.org/>
GNU GENERAL PUBLIC LICENCE Version 3: <http://www.gnu.org/licenses/gpl-3.0.txt>
- <http://fsf.org/>
GNU LESSER GENERAL PUBLIC LICENCE: <http://www.gnu.org/licenses/lgpl.txt>

Eclipse SmartHome

- Copyright © 2016 der Eclipse Foundation
Eclipse Public License - v 2.0: <https://www.eclipse.org/legal/epl-2.0/>

Calimero

- <http://fsf.org/>
GNU GENERAL PUBLIC LICENCE Version 3: <http://www.gnu.org/licenses/gpl-3.0.txt>
- <http://fsf.org/>
GNU LESSER GENERAL PUBLIC LICENCE Version 3:
<http://www.gnu.org/licenses/lgpl.txt>

Comet Visu

- <http://fsf.org/>
GNU GENERAL PUBLIC LICENCE Version 3: <http://www.gnu.org/licenses/gpl-3.0.txt>

Java SE Embedded Runtime Environment

and all Java based trademarks and logos are trademarks or registered trademarks of Oracle and/or its affiliates.



8.1 Open Source Licences

8.1.1 GNU GENERAL PUBLIC LICENCE Version 2 (GPL v2)

GNU GENERAL PUBLIC LICENSE Version 2, June 1991

Copyright (C) 1989, 1991 Free Software Foundation, Inc., 51 Franklin Street, Fifth Floor, Boston, MA 02110-1301 USA Everyone is permitted to copy and distribute verbatim copies of this licence document, but changing it is not allowed.

Preamble

The licences for most software are designed to take away your freedom to share and change it. By contrast, the GNU General Public Licence is intended to guarantee your freedom to share and change free software--to make sure the software is free for all its users. This General Public Licence applies to most of the Free Software Foundation's software and to any other program whose authors commit to using it. (Some other Free Software Foundation software is covered by the GNU Lesser General Public Licence instead.) You can apply it to your programs, too.

When we speak of free software, we are referring to freedom, not price. Our General Public Licences are designed to make sure that you have the freedom to distribute copies of free software (and charge for this service if you wish), that you receive source code or can get it if you want it, that you can change the software or use pieces of it in new free programs; and that you know you can do these things.

To protect your rights, we need to make restrictions that forbid anyone to deny you these rights or to ask you to surrender the rights. These restrictions translate to certain responsibilities for you if you distribute copies of the software, or if you modify it.

For example, if you distribute copies of such a program, whether gratis or for a fee, you must give the recipients all the rights that you have. You must make sure that they, too, receive or can get the source code. And you must show them these terms so they know their rights.

We protect your rights with two steps: (1) copyright the software, and (2) offer you this licence which gives you legal permission to copy, distribute and/or modify the software.

Also, for each author's protection and ours, we want to make certain that everyone understands that there is no warranty for this free software. If the software is modified by someone else and passed on, we want its recipients to know that what they have is not the original, so that any problems introduced by others will not reflect on the original authors' reputations.

Finally, any free program is threatened constantly by software patents. We wish to avoid the danger that redistributors of a free program will individually obtain patent licences, in effect making the program proprietary. To prevent this, we have made it clear that any patent must be licensed for everyone's free use or not licensed at all.

The precise terms and conditions for copying, distribution and modification follow.

GNU GENERAL PUBLIC LICENCE

TERMS AND CONDITIONS FOR COPYING, DISTRIBUTION AND MODIFICATION

0. This Licence applies to any program or other work which contains a notice placed by the copyright holder saying it may be distributed under the terms of this General Public Licence. The "Program", below, refers to any such program or work, and a "work based on the Program" means either the Program or any derivative work under copyright law: that is

to say, a work containing the Program or a portion of it, either verbatim or with modifications and/or translated into another language. (Hereinafter, translation is included without limitation in the term "modification".) Each licensee is addressed as "you".

Activities other than copying, distribution and modification are not covered by this Licence; they are outside its scope. The act of running the Program is not restricted, and the output from the Program is covered only if its contents constitute a work based on the Program (independent of having been made by running the Program). Whether that is true depends on what the Program does.

1. You may copy and distribute verbatim copies of the Program's source code as you receive it, in any medium, provided that you conspicuously and appropriately publish on each copy an appropriate copyright notice and disclaimer of warranty; keep intact all the notices that refer to this Licence and to the absence of any warranty; and give any other recipients of the Program a copy of this Licence along with the Program.

You may charge a fee for the physical act of transferring a copy, and you may at your option offer warranty protection in exchange for a fee.

2. You may modify your copy or copies of the Program or any portion of it, thus forming a work based on the Program, and copy and distribute such modifications or work under the terms of Section 1 above, provided that you also meet all of these conditions:

- a) You must cause the modified files to carry prominent notices stating that you changed the files and the date of any change.
- b) You must cause any work that you distribute or publish, that in whole or in part contains or is derived from the Program or any part thereof, to be licensed as a whole at no charge to all third parties under the terms of this Licence.
- c) If the modified program normally reads commands interactively when run, you must cause it, when started running for such interactive use in the most ordinary way, to print or display an announcement including an appropriate copyright notice and a notice that there is no warranty (or else, saying that you provide a warranty) and that users may redistribute the program under these conditions, and telling the user how to view a copy of this Licence. (Exception: if the Program itself is interactive but does not normally print such an announcement, your work based on the Program is not required to print an announcement.)

These requirements apply to the modified work as a whole. If identifiable sections of that work are not derived from the Program, and can be reasonably considered independent and separate works in themselves, then this Licence, and its terms, do not apply to those sections when you distribute them as separate works. But when you distribute the same sections as part of a whole which is a work based on the Program, the distribution of the whole must be on the terms of this Licence, whose permissions for other licensees extend to the entire whole, and thus to each and every part regardless of who wrote it.

Thus, it is not the intent of this section to claim rights or contest your rights to work written entirely by you; rather, the intent is to exercise the right to control the distribution of derivative or collective works based on the Program.

In addition, mere aggregation of another work not based on the Program with the Program (or with a work based on the Program) on a volume of a storage or distribution medium does not bring the other work under the scope of this Licence.

3. You may copy and distribute the Program (or a work based on it, under Section 2) in object code or executable form under the terms of Sections 1 and 2 above provided that you also do one of the following:

- a) Accompany it with the complete corresponding machine-readable source code, which must be distributed under the terms of Sections 1 and 2 above on a medium customarily used for software interchange; or,
- b) Accompany it with a written offer, valid for at least three years, to give any third party, for a charge no more than your cost of physically performing source distribution, a complete machine-readable copy of the corresponding source code, to be distributed under the terms of Sections 1 and 2 above on a medium customarily used for software interchange; or,
- c) Accompany it with the information you received as to the offer to distribute corresponding source code. (This alternative is allowed only for non-commercial distribution and only if you received the program in object code or executable form with such an offer, in accord with Subsection b above.)

The source code for a work means the preferred form of the work for making modifications to it. For an executable work, complete source code means all the source code for all modules it contains, plus any associated interface definition files, plus the scripts used to control compilation and installation of the executable. However, as a special exception, the source code distributed need not include anything that is normally distributed (in either source or binary form) with the major components (compiler, kernel, and so on) of the operating system on which the executable runs, unless that component itself accompanies the executable.

If distribution of executable or object code is made by offering access to copy from a designated place, then offering equivalent access to copy the source code from the same place counts as distribution of the source code, even though third parties are not compelled to copy the source along with the object code.

4. You may not copy, modify, sublicense, or distribute the Program except as expressly provided under this Licence. Any attempt otherwise to copy, modify, sublicense or distribute the Program is void, and will automatically terminate your rights under this Licence. However, parties who have received copies, or rights, from you under this Licence will not have their licences terminated so long as such parties remain in full compliance.

5. You are not required to accept this Licence, since you have not signed it. However, nothing else grants you permission to modify or distribute the Program or its derivative works. These actions are prohibited by law if you do not accept this Licence. Therefore, by modifying or distributing the Program (or any work based on the Program), you indicate your acceptance of this Licence to do so, and all its terms and conditions for copying, distributing or modifying the Program or works based on it.

6. Each time you redistribute the Program (or any work based on the Program), the recipient automatically receives a licence from the original licensor to copy, distribute or modify the Program subject to these terms and conditions. You may not impose any further restrictions on the recipients' exercise of the rights granted herein. You are not responsible for enforcing compliance by third parties to this Licence.

7. If, as a consequence of a court judgment or allegation of patent infringement or for any other reason (not limited to patent issues), conditions are imposed on you (whether by court order, agreement or otherwise) that contradict the conditions of this Licence, they do

not excuse you from the conditions of this Licence. If you cannot distribute so as to satisfy simultaneously your obligations under this Licence and any other pertinent obligations, then as a consequence you may not distribute the Program at all. For example, if a patent licence would not permit royalty-free redistribution of the Program by all those who receive copies directly or indirectly through you, then the only way you could satisfy both it and this Licence would be to refrain entirely from distribution of the Program.

If any portion of this section is held invalid or unenforceable under any particular circumstance, the balance of the section is intended to apply and the section as a whole is intended to apply in other circumstances.

It is not the purpose of this section to induce you to infringe any patents or other property right claims or to contest validity of any such claims; this section has the sole purpose of protecting the integrity of the free software distribution system, which is implemented by public licence practices. Many people have made generous contributions to the wide range of software distributed through that system in reliance on consistent application of that system; it is up to the author/donor to decide if he or she is willing to distribute software through any other system and a licensee cannot impose that choice.

This section is intended to make thoroughly clear what is believed to be a consequence of the rest of this Licence.

8. If the distribution and/or use of the Program is restricted in certain countries either by patents or by copyrighted interfaces, the original copyright holder who places the Program under this Licence may add an explicit geographical distribution limitation excluding those countries, so that distribution is permitted only in or among countries not thus excluded. In such case, this Licence incorporates the limitation as if written in the body of this Licence.

9. The Free Software Foundation may publish revised and/or new versions of the General Public Licence from time to time. Such new versions will be similar in spirit to the present version, but may differ in detail to address new problems or concerns.

Each version is given a distinguishing version number. If the Program specifies a version number of this Licence which applies to it and "any later version", you have the option of following the terms and conditions either of that version or of any later version published by the Free Software Foundation. If the Program does not specify a version number of this Licence, you may choose any version ever published by the Free Software Foundation.

10. If you wish to incorporate parts of the Program into other free programs whose distribution conditions are different, write to the author to ask for permission. For software which is copyrighted by the Free Software Foundation, write to the Free Software Foundation; we sometimes make exceptions for this. Our decision will be guided by the two goals of preserving the free status of all derivatives of our free software and of promoting the sharing and reuse of software generally.

NO WARRANTY

11. BECAUSE THE PROGRAM IS LICENSED FREE OF CHARGE, THERE IS NO WARRANTY FOR THE PROGRAM, TO THE EXTENT PERMITTED BY APPLICABLE LAW. EXCEPT WHEN OTHERWISE STATED IN WRITING THE COPYRIGHT HOLDERS AND/OR OTHER PARTIES PROVIDE THE PROGRAM "AS IS" WITHOUT WARRANTY OF ANY KIND, EITHER EXPRESSED OR IMPLIED, INCLUDING, BUT NOT LIMITED TO, THE IMPLIED WARRANTIES OF MERCHANTABILITY AND FITNESS FOR A PARTICULAR PURPOSE. THE ENTIRE RISK AS TO THE QUALITY AND PERFORMANCE OF THE PROGRAM IS WITH YOU. SHOULD THE PROGRAM PROVE

DEFECTIVE, YOU ASSUME THE COST OF ALL NECESSARY SERVICING, REPAIR OR CORRECTION.

12. IN NO EVENT UNLESS REQUIRED BY APPLICABLE LAW OR AGREED TO IN WRITING WILL ANY COPYRIGHT HOLDER, OR ANY OTHER PARTY WHO MAY MODIFY AND/OR REDISTRIBUTE THE PROGRAM AS PERMITTED ABOVE, BE LIABLE TO YOU FOR DAMAGES, INCLUDING ANY GENERAL, SPECIAL, INCIDENTAL OR CONSEQUENTIAL DAMAGES ARISING OUT OF THE USE OR INABILITY TO USE THE PROGRAM (INCLUDING BUT NOT LIMITED TO LOSS OF DATA OR DATA BEING RENDERED INACCURATE OR LOSSES SUSTAINED BY YOU OR THIRD PARTIES OR A FAILURE OF THE PROGRAM TO OPERATE WITH ANY OTHER PROGRAMS), EVEN IF SUCH HOLDER OR OTHER PARTY HAS BEEN ADVISED OF THE POSSIBILITY OF SUCH DAMAGES.

END OF TERMS AND CONDITIONS

How to Apply These Terms to Your New Programs

If you develop a new program, and you want it to be of the greatest possible use to the public, the best way to achieve this is to make it free software which everyone can redistribute and change under these terms.

To do so, attach the following notices to the program. It is safest to attach them to the start of each source file to most effectively convey the exclusion of warranty; and each file should have at least the "copyright" line and a pointer to where the full notice is found.

```
<one line to give the program's name and a brief idea of what it does.> Copyright (C)
<year> <name of author>
```

This program is free software; you can redistribute it and/or modify it under the terms of the GNU General Public Licence as published by the Free Software Foundation; either version 2 of the Licence, or (at your option) any later version.

This program is distributed in the hope that it will be useful, but WITHOUT ANY WARRANTY; without even the implied warranty of MERCHANTABILITY or FITNESS FOR A PARTICULAR PURPOSE. See the GNU General Public Licence for more details.

You should have received a copy of the GNU General Public Licence along with this program; if not, write to the Free Software Foundation, Inc., 51 Franklin Street, Fifth Floor, Boston, MA 02110-1301 USA.

Also add information on how to contact you by electronic and paper mail.

If the program is interactive, make it output a short notice like this when it starts in an interactive mode:

```
Gnomovision version 69, Copyright (C) year name of author Gnomovision comes with
ABSOLUTELY NO WARRANTY; for details type `show w'. This is free software, and you
are welcome to redistribute it under certain conditions; type `show c' for details.
```

The hypothetical commands `show w' and `show c' should show the appropriate parts of the General Public Licence. Of course, the commands you use may be called something other than `show w' and `show c'; they could even be mouse-clicks or menu items-- whatever suits your program.

You should also get your employer (if you work as a programmer) or your school, if any, to sign a "copyright disclaimer" for the program, if necessary. Here is a sample; alter the names:

Yoyodyne, Inc., hereby disclaims all copyright interest in the program `Gnomovision' (which makes passes at compilers) written by James Hacker.

<signature of Ty Coon>, 1 April 1989 Ty Coon, President of Vice

This General Public Licence does not permit incorporating your program into proprietary programs. If your program is a subroutine library, you may consider it more useful to permit linking proprietary applications with the library. If this is what you want to do, use the GNU Lesser General Public Licence instead of this Licence.

8.1.2 GNU GENERAL PUBLIC LICENCE Version 3 (GPL v3)

GNU GENERAL PUBLIC LICENCE Version 3, 29 June 2007

Copyright (C) 2007 Free Software Foundation, Inc. <<http://fsf.org/>> Everyone is permitted to copy and distribute verbatim copies of this licence document, but changing it is not allowed.

Preamble

The GNU General Public Licence is a free, copyleft license for software and other kinds of works.

The licences for most software and other practical works are designed to take away your freedom to share and change the works. By contrast, the GNU General Public Licence is intended to guarantee your freedom to share and change all versions of a program--to make sure it remains free software for all its users. We, the Free Software Foundation, use the GNU General Public Licence for most of our software; it applies also to any other work released this way by its authors. You can apply it to your programs, too.

When we speak of free software, we are referring to freedom, not price. Our General Public Licences are designed to make sure that you have the freedom to distribute copies of free software (and charge for them if you wish), that you receive source code or can get it if you want it, that you can change the software or use pieces of it in new free programs, and that you know you can do these things.

To protect your rights, we need to prevent others from denying you these rights or asking you to surrender the rights. Therefore, you have certain responsibilities if you distribute copies of the software, or if you modify it: responsibilities to respect the freedom of others.

For example, if you distribute copies of such a program, whether gratis or for a fee, you must pass on to the recipients the same freedoms that you received. You must make sure that they, too, receive or can get the source code. And you must show them these terms so they know their rights.

Developers that use the GNU GPL protect your rights with two steps: (1) assert copyright on the software, and (2) offer you this Licence giving you legal permission to copy, distribute and/or modify it.

For the developers' and authors' protection, the GPL clearly explains that there is no warranty for this free software. For both users' and authors' sake, the GPL requires that modified versions be marked as changed, so that their problems will not be attributed erroneously to authors of previous versions.

Some devices are designed to deny users access to install or run modified versions of the software inside them, although the manufacturer can do so. This is fundamentally incompatible with the aim of protecting users' freedom to change the software. The systematic pattern of such abuse occurs in the area of products for individuals to use, which is precisely where it is most unacceptable. Therefore, we have designed this version of the GPL to prohibit the practice for those products. If such problems arise substantially in other domains, we stand ready to extend this provision to those domains in future versions of the GPL, as needed to protect the freedom of users.

Finally, every program is threatened constantly by software patents. States should not allow patents to restrict development and use of software on general-purpose computers,

but in those that do, we wish to avoid the special danger that patents applied to a free program could make it effectively proprietary. To prevent this, the GPL assures that patents cannot be used to render the program non-free.

The precise terms and conditions for copying, distribution and modification follow.

TERMS AND CONDITIONS

0. Definitions.

"This Licence" refers to version 3 of the GNU General Public Licence.

"Copyright" also means copyright-like laws that apply to other kinds of works, such as semiconductor masks.

"The Program" refers to any copyrightable work licensed under this Licence. Each licensee is addressed as "you". "Licensees" and "recipients" may be individuals or organisations.

To "modify" a work means to copy from or adapt all or part of the work in a fashion requiring copyright permission, other than the making of an exact copy. The resulting work is called a "modified version" of the earlier work or a work "based on" the earlier work.

A "covered work" means either the unmodified Program or a work based on the Program.

To "propagate" a work means to do anything with it that, without permission, would make you directly or secondarily liable for infringement under applicable copyright law, except executing it on a computer or modifying a private copy. Propagation includes copying, distribution (with or without modification), making available to the public, and in some countries other activities as well.

To "convey" a work means any kind of propagation that enables other parties to make or receive copies. Mere interaction with a user through a computer network, with no transfer of a copy, is not conveying.

An interactive user interface displays "Appropriate Legal Notices" to the extent that it includes a convenient and prominently visible feature that (1) displays an appropriate copyright notice, and (2) tells the user that there is no warranty for the work (except to the extent that warranties are provided), that licensees may convey the work under this Licence, and how to view a copy of this Licence. If the interface presents a list of user commands or options, such as a menu, a prominent item in the list meets this criterion.

1. Source Code.

The "source code" for a work means the preferred form of the work for making modifications to it. "Object code" means any non-source form of a work.

A "Standard Interface" means an interface that either is an official standard defined by a recognised standards body, or, in the case of interfaces specified for a particular programming language, one that is widely used among developers working in that language.

The "System Libraries" of an executable work include anything, other than the work as a whole, that (a) is included in the normal form of packaging a Major Component, but which is not part of that Major Component, and (b) serves only to enable use of the work with that Major Component, or to implement a Standard Interface for which an implementation is

available to the public in source code form. A "Major Component", in this context, means a major essential component (kernel, window system, and so on) of the specific operating system (if any) on which the executable work runs, or a compiler used to produce the work, or an object code interpreter used to run it.

The "Corresponding Source" for a work in object code form means all the source code needed to generate, install, and (for an executable work) run the object code and to modify the work, including scripts to control those activities. However, it does not include the work's System Libraries, or general-purpose tools or generally available free programs which are used unmodified in performing those activities but which are not part of the work. For example, Corresponding Source includes interface definition files associated with source files for the work, and the source code for shared libraries and dynamically linked subprograms that the work is specifically designed to require, such as by intimate data communication or control flow between those subprograms and other parts of the work.

The Corresponding Source need not include anything that users can regenerate automatically from other parts of the Corresponding Source.

The Corresponding Source for a work in source code form is that same work.

2. Basic Permissions.

All rights granted under this Licence are granted for the term of copyright on the Program, and are irrevocable provided the stated conditions are met. This Licence explicitly affirms your unlimited permission to run the unmodified Program. The output from running a covered work is covered by this Licence only if the output, given its content, constitutes a covered work. This Licence acknowledges your rights of fair use or other equivalent, as provided by copyright law.

You may make, run and propagate covered works that you do not convey, without conditions so long as your license otherwise remains in force. You may convey covered works to others for the sole purpose of having them make modifications exclusively for you, or provide you with facilities for running those works, provided that you comply with the terms of this Licence in conveying all material for which you do not control copyright. Those thus making or running the covered works for you must do so exclusively on your behalf, under your direction and control, on terms that prohibit them from making any copies of your copyrighted material outside their relationship with you.

Conveying under any other circumstances is permitted solely under the conditions stated below. Sublicensing is not allowed; section 10 makes it unnecessary.

3. Protecting Users' Legal Rights From Anti-Circumvention Law.

No covered work shall be deemed part of an effective technological measure under any applicable law fulfilling obligations under article 11 of the WIPO copyright treaty adopted on 20 December 1996, or similar laws prohibiting or restricting circumvention of such measures.

When you convey a covered work, you waive any legal power to forbid circumvention of technological measures to the extent such circumvention is effected by exercising rights under this Licence with respect to the covered work, and you disclaim any intention to limit operation or modification of the work as a means of enforcing, against the work's users, your or third parties' legal rights to forbid circumvention of technological measures.

4. Conveying Verbatim Copies.

You may convey verbatim copies of the Program's source code as you receive it, in any medium, provided that you conspicuously and appropriately publish on each copy an appropriate copyright notice; keep intact all notices stating that this Licence and any non-permissive terms added in accord with section 7 apply to the code; keep intact all notices of the absence of any warranty; and give all recipients a copy of this Licence along with the Program.

You may charge any price or no price for each copy that you convey, and you may offer support or warranty protection for a fee.

5. Conveying Modified Source Versions.

You may convey a work based on the Program, or the modifications to produce it from the Program, in the form of source code under the terms of section 4, provided that you also meet all of these conditions:

- a) The work must carry prominent notices stating that you modified it, and giving a relevant date.
- b) The work must carry prominent notices stating that it is released under this Licence and any conditions added under section 7. This requirement modifies the requirement in section 4 to "keep intact all notices".
- c) You must license the entire work, as a whole, under this Licence to anyone who comes into possession of a copy. This Licence will therefore apply, along with any applicable section 7 additional terms, to the whole of the work, and all its parts, regardless of how they are packaged. This Licence gives no permission to license the work in any other way, but it does not invalidate such permission if you have separately received it.
- d) If the work has interactive user interfaces, each must display Appropriate Legal Notices; however, if the Program has interactive interfaces that do not display Appropriate Legal Notices, your work need not make them do so.

A compilation of a covered work with other separate and independent works, which are not by their nature extensions of the covered work, and which are not combined with it such as to form a larger program, in or on a volume of a storage or distribution medium, is called an "aggregate" if the compilation and its resulting copyright are not used to limit the access or legal rights of the compilation's users beyond what the individual works permit. Inclusion of a covered work in an aggregate does not cause this Licence to apply to the other parts of the aggregate.

6. Conveying Non-Source Forms.

You may convey a covered work in object code form under the terms of sections 4 and 5, provided that you also convey the machine-readable Corresponding Source under the terms of this Licence, in one of these ways:

- a) Convey the object code in, or embodied in, a physical product (including a physical distribution medium), accompanied by the Corresponding Source fixed on a durable physical medium customarily used for software interchange.
- b) Convey the object code in, or embodied in, a physical product (including a physical distribution medium), accompanied by a written offer, valid for at least three years and valid for as long as you offer spare parts or customer support for that product model, to give anyone who possesses the object code either (1) a copy of the Corresponding Source for all the software in the product that is covered by this Licence, on a durable

physical medium customarily used for software interchange, for a price no more than your reasonable cost of physically performing this conveying of source, or (2) access to copy the Corresponding Source from a network server at no charge.

- c) Convey individual copies of the object code with a copy of the written offer to provide the Corresponding Source. This alternative is allowed only occasionally and noncommercially, and only if you received the object code with such an offer, in accord with subsection 6b.
- d) Convey the object code by offering access from a designated place (gratis or for a charge), and offer equivalent access to the Corresponding Source in the same way through the same place at no further charge. You need not require recipients to copy the Corresponding Source along with the object code. If the place to copy the object code is a network server, the Corresponding Source may be on a different server (operated by you or a third party) that supports equivalent copying facilities, provided you maintain clear directions next to the object code saying where to find the Corresponding Source. Regardless of what server hosts the Corresponding Source, you remain obligated to ensure that it is available for as long as needed to satisfy these requirements.
- e) Convey the object code using peer-to-peer transmission, provided you inform other peers where the object code and Corresponding Source of the work are being offered to the general public at no charge under subsection 6d.

A separable portion of the object code, whose source code is excluded from the Corresponding Source as a System Library, need not be included in conveying the object code work.

A "User Product" is either (1) a "consumer product", which means any tangible personal property which is normally used for personal, family, or household purposes, or (2) anything designed or sold for incorporation into a dwelling. In determining whether a product is a consumer product, doubtful cases shall be resolved in favour of coverage. For a particular product received by a particular user, "normally used" refers to a typical or common use of that class of product, regardless of the status of the particular user or of the way in which the particular user actually uses, or expects or is expected to use, the product. A product is a consumer product regardless of whether the product has substantial commercial, industrial or non-consumer uses, unless such uses represent the only significant mode of use of the product.

"Installation Information" for a User Product means any methods, procedures, authorisation keys, or other information required to install and execute modified versions of a covered work in that User Product from a modified version of its Corresponding Source. The information must suffice to ensure that the continued functioning of the modified object code is in no case prevented or interfered with solely because a modification has been made.

If you convey an object code work under this section in, or with, or specifically for use in, a User Product, and the conveying occurs as part of a transaction in which the right of possession and use of the User Product is transferred to the recipient in perpetuity or for a fixed term (regardless of how the transaction is characterised), the Corresponding Source conveyed under this section must be accompanied by the Installation Information. But this requirement does not apply if neither you nor any third party retains the ability to install modified object code on the User Product (for example, the work has been installed in ROM).

The requirement to provide Installation Information does not include a requirement to continue to provide support service, warranty, or updates for a work that has been modified or installed by the recipient, or for the User Product in which it has been modified or installed. Access to a network may be denied when the modification itself materially and adversely affects the operation of the network or violates the rules and protocols for communication across the network.

Corresponding Source conveyed and Installation Information provided, in accordance with this section must be in a format that is publicly documented (and with an implementation available to the public in source code form), and must require no special password or key for unpacking, reading or copying.

7. Additional Terms.

"Additional permissions" are terms that supplement the terms of this Licence by making exceptions from one or more of its conditions. Additional permissions that are applicable to the entire Program shall be treated as though they were included in this Licence, to the extent that they are valid under applicable law. If additional permissions apply only to part of the Program, that part may be used separately under those permissions, but the entire Program remains governed by this Licence without regard to the additional permissions.

When you convey a copy of a covered work, you may at your option remove any additional permissions from that copy, or from any part of it. (Additional permissions may be written to require their own removal in certain cases when you modify the work.) You may place additional permissions on material, added by you to a covered work, for which you have or can give appropriate copyright permission.

Notwithstanding any other provision of this Licence, for material you add to a covered work, you may (if authorised by the copyright holders of that material) supplement the terms of this Licence with terms:

- a) Disclaiming warranty or limiting liability differently from the terms of sections 15 and 16 of this Licence; or
- b) Requiring preservation of specified reasonable legal notices or author attributions in that material or in the Appropriate Legal Notices displayed by works containing it; or
- c) Prohibiting misrepresentation of the origin of that material, or requiring that modified versions of such material be marked in reasonable ways as different from the original version; or
- d) Limiting the use for publicity purposes of names of licensors or authors of the material; or
- e) Declining to grant rights under trademark law for use of some trade names, trademarks, or service marks; or
- f) Requiring indemnification of licensors and authors of that material by anyone who conveys the material (or modified versions of it) with contractual assumptions of liability to the recipient, for any liability that these contractual assumptions directly impose on those licensors and authors.

All other non-permissive additional terms are considered "further restrictions" within the meaning of section 10. If the Program as you received it, or any part of it, contains a notice stating that it is governed by this Licence along with a term that is a further restriction, you may remove that term. If a licence document contains a further restriction but permits

relicensing or conveying under this Licence, you may add to a covered work material governed by the terms of that licence document, provided that the further restriction does not survive such relicensing or conveying.

If you add terms to a covered work in accord with this section, you must place, in the relevant source files, a statement of the additional terms that apply to those files, or a notice indicating where to find the applicable terms.

Additional terms, permissive or non-permissive, may be stated in the form of a separately written licence, or stated as exceptions; the above requirements apply either way.

8. Termination.

You may not propagate or modify a covered work except as expressly provided under this Licence. Any attempt otherwise to propagate or modify it is void, and will automatically terminate your rights under this Licence (including any patent licences granted under the third paragraph of section 11).

However, if you cease all violation of this Licence, then your licence from a particular copyright holder is reinstated (a) provisionally, unless and until the copyright holder explicitly and finally terminates your licence, and (b) permanently, if the copyright holder fails to notify you of the violation by some reasonable means prior to 60 days after the cessation.

Moreover, your licence from a particular copyright holder is reinstated permanently if the copyright holder notifies you of the violation by some reasonable means, this is the first time you have received notice of violation of this Licence (for any work) from that copyright holder, and you cure the violation prior to 30 days after your receipt of the notice.

Termination of your rights under this section does not terminate the licences of parties who have received copies or rights from you under this Licence. If your rights have been terminated and not permanently reinstated, you do not qualify to receive new licences for the same material under section 10.

9. Acceptance Not Required for Having Copies.

You are not required to accept this Licence in order to receive or run a copy of the Program. Ancillary propagation of a covered work occurring solely as a consequence of using peer-to-peer transmission to receive a copy likewise does not require acceptance. However, nothing other than this Licence grants you permission to propagate or modify any covered work. These actions infringe copyright if you do not accept this Licence. Therefore, by modifying or propagating a covered work, you indicate your acceptance of this Licence to do so.

10. Automatic Licensing of Downstream Recipients. Each time you convey a covered work, the recipient automatically receives a licence from the original licensors, to run, modify and propagate that work, subject to this Licence. You are not responsible for enforcing compliance by third parties with this Licence.

An "entity transaction" is a transaction transferring control of an organisation, or substantially all assets of one, or subdividing an organisation, or merging organisations. If propagation of a covered work results from an entity transaction, each party to that transaction who receives a copy of the work also receives whatever licences to the work the party's predecessor in interest had or could give under the previous paragraph, plus a right to possession of the Corresponding Source of the work from the predecessor in interest, if the predecessor has it or can get it with reasonable efforts.

You may not impose any further restrictions on the exercise of the rights granted or affirmed under this Licence. For example, you may not impose a licence fee, royalty, or other charge for exercise of rights granted under this Licence, and you may not initiate litigation (including a cross-claim or counterclaim in a lawsuit) alleging that any patent claim is infringed by making, using, selling, offering for sale, or importing the Program or any portion of it.

11. Patents.

A "contributor" is a copyright holder who authorises use under this Licence of the Program or a work on which the Program is based. The work thus licensed is called the contributor's "contributor version".

A contributor's "essential patent claims" are all patent claims owned or controlled by the contributor, whether already acquired or hereafter acquired, that would be infringed by some manner, permitted by this Licence, of making, using, or selling its contributor version, but do not include claims that would be infringed only as a consequence of further modification of the contributor version. For purposes of this definition, "control" includes the right to grant patent sublicenses in a manner consistent with the requirements of this Licence.

Each contributor grants you a non-exclusive, worldwide, royalty-free patent licence under the contributor's essential patent claims, to make, use, sell, offer for sale, import and otherwise run, modify and propagate the contents of its contributor version.

In the following three paragraphs, a "patent licence" is any express agreement or commitment, however denominated, not to enforce a patent (such as an express permission to practice a patent or covenant not to sue for patent infringement). To "grant" such a patent licence to a party means to make such an agreement or commitment not to enforce a patent against the party.

If you convey a covered work, knowingly relying on a patent licence, and the Corresponding Source of the work is not available for anyone to copy, free of charge and under the terms of this Licence, through a publicly available network server or other readily accessible means, then you must either (1) cause the Corresponding Source to be so available, or (2) arrange to deprive yourself of the benefit of the patent licence for this particular work, or (3) arrange, in a manner consistent with the requirements of this Licence, to extend the patent licence to downstream recipients. "Knowingly relying" means you have actual knowledge that, but for the patent licence, your conveying the covered work in a country, or your recipient's use of the covered work in a country, would infringe one or more identifiable patents in that country that you have reason to believe are valid.

If, pursuant to or in connection with a single transaction or arrangement, you convey, or propagate by procuring conveyance of, a covered work, and grant a patent licence to some of the parties receiving the covered work authorising them to use, propagate, modify or convey a specific copy of the covered work, then the patent licence you grant is automatically extended to all recipients of the covered work and works based on it.

A patent licence is "discriminatory" if it does not include within the scope of its coverage, prohibits the exercise of, or is conditioned on the non-exercise of one or more of the rights that are specifically granted under this Licence. You may not convey a covered work if you are a party to an arrangement with a third party that is in the business of distributing software, under which you make payment to the third party based on the extent of your activity of conveying the work, and under which the third party grants, to any of the parties

who would receive the covered work from you, a discriminatory patent licence (a) in connection with copies of the covered work conveyed by you (or copies made from those copies), or (b) primarily for and in connection with specific products or compilations that contain the covered work, unless you entered into that arrangement, or that patent licence was granted, prior to 28 March 2007.

Nothing in this Licence shall be construed as excluding or limiting any implied licence or other defences to infringement that may otherwise be available to you under applicable patent law.

12. No Surrender of Others' Freedom.

If conditions are imposed on you (whether by court order, agreement or otherwise) that contradict the conditions of this Licence, they do not excuse you from the conditions of this Licence. If you cannot convey a covered work so as to satisfy simultaneously your obligations under this Licence and any other pertinent obligations, then as a consequence you may not convey it at all. For example, if you agree to terms that obligate you to collect a royalty for further conveying from those to whom you convey the Program, the only way you could satisfy both those terms and this Licence would be to refrain entirely from conveying the Program.

13. Use with the GNU Affero General Public Licence.

Notwithstanding any other provision of this Licence, you have permission to link or combine any covered work with a work licensed under version 3 of the GNU Affero General Public Licence into a single combined work, and to convey the resulting work. The terms of this Licence will continue to apply to the part which is the covered work, but the special requirements of the GNU Affero General Public Licence, section 13, concerning interaction through a network will apply to the combination as such.

14. Revised Versions of this Licence.

The Free Software Foundation may publish revised and/or new versions of the GNU General Public Licence from time to time. Such new versions will be similar in spirit to the present version, but may differ in detail to address new problems or concerns.

Each version is given a distinguishing version number. If the Program specifies that a certain numbered version of the GNU General Public Licence "or any later version" applies to it, you have the option of following the terms and conditions either of that numbered version or of any later version published by the Free Software Foundation. If the Program does not specify a version number of the GNU General Public Licence, you may choose any version ever published by the Free Software Foundation.

If the Program specifies that a proxy can decide which future versions of the GNU General Public Licence can be used, that proxy's public statement of acceptance of a version permanently authorises you to choose that version for the Program.

Later licence versions may give you additional or different permissions. However, no additional obligations are imposed on any author or copyright holder as a result of your choosing to follow a later version.

15. Disclaimer of Warranty.

THERE IS NO WARRANTY FOR THE PROGRAM, TO THE EXTENT PERMITTED BY APPLICABLE LAW. EXCEPT WHEN OTHERWISE STATED IN WRITING THE COPYRIGHT HOLDERS AND/OR OTHER PARTIES PROVIDE THE PROGRAM "AS IS"

WITHOUT WARRANTY OF ANY KIND, EITHER EXPRESSED OR IMPLIED, INCLUDING, BUT NOT LIMITED TO, THE IMPLIED WARRANTIES OF MERCHANTABILITY AND FITNESS FOR A PARTICULAR PURPOSE. THE ENTIRE RISK AS TO THE QUALITY AND PERFORMANCE OF THE PROGRAM IS WITH YOU. SHOULD THE PROGRAM PROVE DEFECTIVE, YOU ASSUME THE COST OF ALL NECESSARY SERVICING, REPAIR OR CORRECTION.

16. Limitation of Liability.

IN NO EVENT UNLESS REQUIRED BY APPLICABLE LAW OR AGREED TO IN WRITING WILL ANY COPYRIGHT HOLDER, OR ANY OTHER PARTY WHO MODIFIES AND/OR CONVEYS THE PROGRAM AS PERMITTED ABOVE, BE LIABLE TO YOU FOR DAMAGES, INCLUDING ANY GENERAL, SPECIAL, INCIDENTAL OR CONSEQUENTIAL DAMAGES ARISING OUT OF THE USE OR INABILITY TO USE THE PROGRAM (INCLUDING BUT NOT LIMITED TO LOSS OF DATA OR DATA BEING RENDERED INACCURATE OR LOSSES SUSTAINED BY YOU OR THIRD PARTIES OR A FAILURE OF THE PROGRAM TO OPERATE WITH ANY OTHER PROGRAMS), EVEN IF SUCH HOLDER OR OTHER PARTY HAS BEEN ADVISED OF THE POSSIBILITY OF SUCH DAMAGES.

17. Interpretation of Sections 15 and 16.

If the disclaimer of warranty and limitation of liability provided above cannot be given local legal effect according to their terms, reviewing courts shall apply local law that most closely approximates an absolute waiver of all civil liability in connection with the Program, unless a warranty or assumption of liability accompanies a copy of the Program in return for a fee.

END OF TERMS AND CONDITIONS

How to Apply These Terms to Your New Programs

If you develop a new program, and you want it to be of the greatest possible use to the public, the best way to achieve this is to make it free software which everyone can redistribute and change under these terms.

To do so, attach the following notices to the program. It is safest to attach them to the start of each source file to most effectively state the exclusion of warranty; and each file should have at least the "copyright" line and a pointer to where the full notice is found.

```
<one line to give the program's name and a brief idea of what it does.> Copyright (C)
<year> <name of author>
```

This program is free software: you can redistribute it and/or modify it under the terms of the GNU General Public Licence as published by the Free Software Foundation, either version 3 of the Licence, or (at your option) any later version.

This program is distributed in the hope that it will be useful, but WITHOUT ANY WARRANTY; without even the implied warranty of MERCHANTABILITY or FITNESS FOR A PARTICULAR PURPOSE. See the GNU General Public Licence for more details.

You should have received a copy of the GNU General Public Licence along with this program. If not, see <http://www.gnu.org/licenses/>.

Also add information on how to contact you by electronic and paper mail.

If the program does terminal interaction, make it output a short notice like this when it starts in an interactive mode:

```
<program> Copyright (C) <year> <name of author> This program comes with  
ABSOLUTELY NO WARRANTY; for details type `show w'. This is free software, and you  
are welcome to redistribute it under certain conditions; type `show c' for details.
```

The hypothetical commands `show w' and `show c' should show the appropriate parts of the General Public Licence. Of course, your program's commands might be different; for a GUI interface, you would use an "about box".

You should also get your employer (if you work as a programmer) or school, if any, to sign a "copyright disclaimer" for the program, if necessary. For more information on this, and how to apply and follow the GNU GPL, see <http://www.gnu.org/licenses/>.

The GNU General Public Licence does not permit incorporating your program into proprietary programs. If your program is a subroutine library, you may consider it more useful to permit linking proprietary applications with the library. If this is what you want to do, use the GNU Lesser General Public Licence instead of this Licence. But first, please read <http://www.gnu.org/philosophy/why-not-lgpl.html>.

8.1.3 GNU LESSER GENERAL PUBLIC LICENCE Version 3 (LGPL)

GNU LESSER GENERAL PUBLIC LICENCE Version 3, 29 June 2007

<http://fsf.org/>. Everyone is permitted to copy and distribute verbatim copies of this licence document, but changing it is not allowed.

This version of the GNU Lesser General Public Licence incorporates the terms and conditions of version 3 of the GNU General Public Licence, supplemented by the additional permissions listed below.

0. Additional Definitions.

As used herein, "this Licence" refers to version 3 of the GNU Lesser General Public Licence, and the "GNU GPL" refers to version 3 of the GNU General Public Licence.

"The Library" refers to a covered work governed by this Licence, other than an Application or a Combined Work as defined below.

An "Application" is any work that makes use of an interface provided by the Library, but which is not otherwise based on the Library. Defining a subclass of a class defined by the Library is deemed a mode of using an interface provided by the Library.

A "Combined Work" is a work produced by combining or linking an Application with the Library. The particular version of the Library with which the Combined Work was made is also called the "Linked Version".

The "Minimal Corresponding Source" for a Combined Work means the Corresponding Source for the Combined Work, excluding any source code for portions of the Combined Work that, considered in isolation, are based on the Application, and not on the Linked Version.

The "Corresponding Application Code" for a Combined Work means the object code and/or source code for the Application, including any data and utility programs needed for reproducing the Combined Work from the Application, but excluding the System Libraries of the Combined Work.

1. Exception to Section 3 of the GNU GPL.

You may convey a covered work under sections 3 and 4 of this Licence without being bound by section 3 of the GNU GPL.

2. Conveying Modified Versions.

If you modify a copy of the Library, and, in your modifications, a facility refers to a function or data to be supplied by an Application that uses the facility (other than as an argument passed when the facility is invoked), then you may convey a copy of the modified version:

- a) under this Licence, provided that you make a good faith effort to ensure that, in the event an Application does not supply the function or data, the facility still operates, and performs whatever part of its purpose remains meaningful, or
- b) under the GNU GPL, with none of the additional permissions of this Licence applicable to that copy.

3. Object Code Incorporating Material from Library Header Files.

The object code form of an Application may incorporate material from a header file that is part of the Library. You may convey such object code under terms of your choice, provided that, if the incorporated material is not limited to numerical parameters, data structure layouts and accessors, or small macros, inline functions and templates (ten or fewer lines in length), you do both of the following:

- a) Give prominent notice with each copy of the object code that the Library is used in it and that the Library and its use are covered by this Licence.
- b) Accompany the object code with a copy of the GNU GPL and this licence document.

4. Combined Works.

You may convey a Combined Work under terms of your choice that, taken together, effectively do not restrict modification of the portions of the Library contained in the Combined Work and reverse engineering for debugging such modifications, if you also do each of the following:

- a) Give prominent notice with each copy of the Combined Work that the Library is used in it and that the Library and its use are covered by this Licence.
- b) Accompany the Combined Work with a copy of the GNU GPL and this licence document.
- c) For a Combined Work that displays copyright notices during execution, include the copyright notice for the Library among these notices, as well as a reference directing the user to the copies of the GNU GPL and this licence document.
- d) Do one of the following:

0) Convey the Minimal Corresponding Source under the terms of this Licence, and the Corresponding Application Code in a form suitable for, and under terms that permit, the user to recombine or relink the Application with a modified version of the Linked Version to produce a modified Combined Work, in the manner specified by section 6 of the GNU GPL for conveying Corresponding Source.

1) Use a suitable shared library mechanism for linking with the Library. A suitable mechanism is one that (a) uses at run time a copy of the Library already present on the user's computer system, and (b) will operate properly with a modified version of the Library that is interface-compatible with the Linked Version.

- e) Provide Installation Information, but only if you would otherwise be required to provide such information under section 6 of the GNU GPL, and only to the extent that such information is necessary to install and execute a modified version of the Combined Work produced by recombining or relinking the Application with a modified version of the Linked Version. (If you use option 4d0, the Installation Information must accompany the Minimal Corresponding Source and Corresponding Application Code. If you use option 4d1, you must provide the Installation Information in the manner specified by section 6 of the GNU GPL for conveying Corresponding Source.)

5. Combined Libraries.

You may place library facilities that are a work based on the Library side by side in a single library together with other library facilities that are not Applications and are not

covered by this Licence, and convey such a combined library under terms of your choice, if you do both of the following:

- a) Accompany the combined library with a copy of the same work based on the Library, not combined with any other library facilities, conveyed under the terms of this Licence.
- b) Give prominent notice with the combined library that part of it is a work based on the Library, and explaining where to find the accompanying non-combined form of the same work.

6. Revised Versions of the GNU Lesser General Public Licence.

The Free Software Foundation may publish revised and/or new versions of the GNU Lesser General Public Licence from time to time. Such new versions will be similar in spirit to the present version, but may differ in detail to address new problems or concerns.

Each version is given a distinguishing version number. If the Library as you received it specifies that a certain numbered version of the GNU Lesser General Public Licence "or any later version" applies to it, you have the option of following the terms and conditions either of that published version or of any later version published by the Free Software Foundation. If the Library as you received it does not specify a version number of the GNU Lesser General Public Licence, you may choose any version of the GNU Lesser General Public Licence ever published by the Free Software Foundation.

If the Library as you received it specifies that a proxy can decide whether future versions of the GNU Lesser General Public Licence shall apply, that proxy's public statement of acceptance of any version is permanent authorisation for you to choose that version for the Library.

8.1.4 Eclipse Public Licence - v 2.0

Eclipse Public License - v 2.0

THE ACCOMPANYING PROGRAM IS PROVIDED UNDER THE TERMS OF THIS ECLIPSE PUBLIC LICENSE ("AGREEMENT"). ANY USE, REPRODUCTION OR DISTRIBUTION OF THE PROGRAM CONSTITUTES RECIPIENT'S ACCEPTANCE OF THIS AGREEMENT.

1. DEFINITIONS

"Contribution" means:

a) in the case of the initial Contributor, the initial content Distributed under this Agreement, and

b) in the case of each subsequent Contributor:

i) changes to the Program, and

ii) additions to the Program;

where such changes and/or additions to the Program originate from and are Distributed by that particular Contributor. A Contribution "originates" from a Contributor if it was added to the Program by such Contributor itself or anyone acting on such Contributor's behalf. Contributions do not include changes or additions to the Program that are not Modified Works.

"Contributor" means any person or entity that Distributes the Program.

"Licensed Patents" mean patent claims licensable by a Contributor which are necessarily infringed by the use or sale of its Contribution alone or when combined with the Program.

"Program" means the Contributions Distributed in accordance with this Agreement.

"Recipient" means anyone who receives the Program under this Agreement or any Secondary License (as applicable), including Contributors.

"Derivative Works" shall mean any work, whether in Source Code or other form, that is based on (or derived from) the Program and for which the editorial revisions, annotations, elaborations, or other modifications represent, as a whole, an original work of authorship.

"Modified Works" shall mean any work in Source Code or other form that results from an addition to, deletion from, or modification of the contents of the Program, including, for purposes of clarity any new file in Source Code form that contains any contents of the Program. Modified Works shall not include works that contain only declarations, interfaces, types, classes, structures, or files of the Program solely in each case in order to link to, bind by name, or subclass the Program or Modified Works thereof.

"Distribute" means the acts of a) distributing or b) making available in any manner that enables the transfer of a copy.

"Source Code" means the form of a Program preferred for making modifications, including but not limited to software source code, documentation source, and configuration files.

"Secondary License" means either the GNU General Public License, Version 2.0, or any later versions of that license, including any exceptions or additional permissions as identified by the initial Contributor.

2. GRANT OF RIGHTS

a) Subject to the terms of this Agreement, each Contributor hereby grants Recipient a non-exclusive, worldwide, royalty-free copyright license to reproduce, prepare Derivative Works

of, publicly display, publicly perform, Distribute and sublicense the Contribution of such Contributor, if any, and such Derivative Works.

b) Subject to the terms of this Agreement, each Contributor hereby grants Recipient a non-exclusive, worldwide, royalty-free patent license under Licensed Patents to make, use, sell, offer to sell, import and otherwise transfer the Contribution of such Contributor, if any, in Source Code or other form. This patent license shall apply to the combination of the Contribution and the Program if, at the time the Contribution is added by the Contributor, such addition of the Contribution causes such combination to be covered by the Licensed Patents. The patent license shall not apply to any other combinations which include the Contribution. No hardware per se is licensed hereunder.

c) Recipient understands that although each Contributor grants the licenses to its Contributions set forth herein, no assurances are provided by any Contributor that the Program does not infringe the patent or other intellectual property rights of any other entity. Each Contributor disclaims any liability to Recipient for claims brought by any other entity based on infringement of intellectual property rights or otherwise. As a condition to exercising the rights and licenses granted hereunder, each Recipient hereby assumes sole responsibility to secure any other intellectual property rights needed, if any. For example, if a third party patent license is required to allow Recipient to Distribute the Program, it is Recipient's responsibility to acquire that license before distributing the Program.

d) Each Contributor represents that to its knowledge it has sufficient copyright rights in its Contribution, if any, to grant the copyright license set forth in this Agreement.

e) Notwithstanding the terms of any Secondary License, no Contributor makes additional grants to any Recipient (other than those set forth in this Agreement) as a result of such Recipient's receipt of the Program under the terms of a Secondary License (if permitted under the terms of Section 3).

3. REQUIREMENTS

3.1 If a Contributor Distributes the Program in any form, then:

a) the Program must also be made available as Source Code, in accordance with section 3.2, and the Contributor must accompany the Program with a statement that the Source Code for the Program is available under this Agreement, and informs Recipients how to obtain it in a reasonable manner on or through a medium customarily used for software exchange; and

b) the Contributor may Distribute the Program under a license different than this Agreement, provided that such license:

i) effectively disclaims on behalf of all other Contributors all warranties and conditions, express and implied, including warranties or conditions of title and non-infringement, and implied warranties or conditions of merchantability and fitness for a particular purpose;

ii) effectively excludes on behalf of all other Contributors all liability for damages, including direct, indirect, special, incidental and consequential damages, such as lost profits;

iii) does not attempt to limit or alter the recipients' rights in the Source Code under section 3.2; and

iv) requires any subsequent distribution of the Program by any party to be under a license that satisfies the requirements of this section 3.

3.2 When the Program is Distributed as Source Code:

a) it must be made available under this Agreement, or if the Program (i) is combined with other material in a separate file or files made available under a Secondary License, and (ii) the initial Contributor attached to the Source Code the notice described in Exhibit A of this Agreement, then the Program may be made available under the terms of such Secondary Licenses, and

b) a copy of this Agreement must be included with each copy of the Program.

3.3 Contributors may not remove or alter any copyright, patent, trademark, attribution notices, disclaimers of warranty, or limitations of liability ('notices') contained within the Program from any copy of the Program which they Distribute, provided that Contributors may add their own appropriate notices.

4. COMMERCIAL DISTRIBUTION

Commercial distributors of software may accept certain responsibilities with respect to end users, business partners and the like. While this license is intended to facilitate the commercial use of the Program, the Contributor who includes the Program in a commercial product offering should do so in a manner which does not create potential liability for other Contributors. Therefore, if a Contributor includes the Program in a commercial product offering, such Contributor ("Commercial Contributor") hereby agrees to defend and indemnify every other Contributor ("Indemnified Contributor") against any losses, damages and costs (collectively "Losses") arising from claims, lawsuits and other legal actions brought by a third party against the Indemnified Contributor to the extent caused by the acts or omissions of such Commercial Contributor in connection with its distribution of the Program in a commercial product offering. The obligations in this section do not apply to any claims or Losses relating to any actual or alleged intellectual property infringement. In order to qualify, an Indemnified Contributor must: a) promptly notify the Commercial Contributor in writing of such claim, and b) allow the Commercial Contributor to control, and cooperate with the Commercial Contributor in, the defense and any related settlement negotiations. The Indemnified Contributor may participate in any such claim at its own expense.

For example, a Contributor might include the Program in a commercial product offering, Product X. That Contributor is then a Commercial Contributor. If that Commercial Contributor then makes performance claims, or offers warranties related to Product X, those performance claims and warranties are such Commercial Contributor's responsibility alone. Under this section, the Commercial Contributor would have to defend claims against the other Contributors related to those performance claims and warranties, and if a court requires any other Contributor to pay any damages as a result, the Commercial Contributor must pay those damages.

5. NO WARRANTY

EXCEPT AS EXPRESSLY SET FORTH IN THIS AGREEMENT, AND TO THE EXTENT PERMITTED BY APPLICABLE LAW, THE PROGRAM IS PROVIDED ON AN "AS IS" BASIS, WITHOUT WARRANTIES OR CONDITIONS OF ANY KIND, EITHER EXPRESS OR IMPLIED INCLUDING, WITHOUT LIMITATION, ANY WARRANTIES OR CONDITIONS OF TITLE, NON-INFRINGEMENT, MERCHANTABILITY OR FITNESS FOR A PARTICULAR PURPOSE. Each Recipient is solely responsible for determining the appropriateness of using and distributing the Program and assumes all risks associated with its exercise of rights under this Agreement, including but not limited to the risks and costs of program errors, compliance with applicable laws, damage to or loss of data, programs or equipment, and unavailability or interruption of operations.

6. DISCLAIMER OF LIABILITY

EXCEPT AS EXPRESSLY SET FORTH IN THIS AGREEMENT, AND TO THE EXTENT PERMITTED BY APPLICABLE LAW, NEITHER RECIPIENT NOR ANY CONTRIBUTORS SHALL HAVE ANY LIABILITY FOR ANY DIRECT, INDIRECT, INCIDENTAL, SPECIAL, EXEMPLARY, OR CONSEQUENTIAL DAMAGES (INCLUDING WITHOUT LIMITATION LOST PROFITS), HOWEVER CAUSED AND ON ANY THEORY OF LIABILITY, WHETHER IN CONTRACT, STRICT LIABILITY, OR TORT (INCLUDING NEGLIGENCE OR OTHERWISE) ARISING IN ANY WAY OUT OF THE USE OR DISTRIBUTION OF THE PROGRAM OR THE EXERCISE OF ANY RIGHTS GRANTED HEREUNDER, EVEN IF ADVISED OF THE POSSIBILITY OF SUCH DAMAGES.

7. GENERAL

If any provision of this Agreement is invalid or unenforceable under applicable law, it shall not affect the validity or enforceability of the remainder of the terms of this Agreement, and

without further action by the parties hereto, such provision shall be reformed to the minimum extent necessary to make such provision valid and enforceable.

If Recipient institutes patent litigation against any entity (including a cross-claim or counterclaim in a lawsuit) alleging that the Program itself (excluding combinations of the Program with other software or hardware) infringes such Recipient's patent(s), then such Recipient's rights granted under Section 2(b) shall terminate as of the date such litigation is filed.

All Recipient's rights under this Agreement shall terminate if it fails to comply with any of the material terms or conditions of this Agreement and does not cure such failure in a reasonable period of time after becoming aware of such noncompliance. If all Recipient's rights under this Agreement terminate, Recipient agrees to cease use and distribution of the Program as soon as reasonably practicable. However, Recipient's obligations under this Agreement and any licenses granted by Recipient relating to the Program shall continue and survive.

Everyone is permitted to copy and distribute copies of this Agreement, but in order to avoid inconsistency the Agreement is copyrighted and may only be modified in the following manner. The Agreement Steward reserves the right to publish new versions (including revisions) of this Agreement from time to time. No one other than the Agreement Steward has the right to modify this Agreement. The Eclipse Foundation is the initial Agreement Steward. The Eclipse Foundation may assign the responsibility to serve as the Agreement Steward to a suitable separate entity. Each new version of the Agreement will be given a distinguishing version number. The Program (including Contributions) may always be Distributed subject to the version of the Agreement under which it was received. In addition, after a new version of the Agreement is published, Contributor may elect to Distribute the Program (including its Contributions) under the new version.

Except as expressly stated in Sections 2(a) and 2(b) above, Recipient receives no rights or licenses to the intellectual property of any Contributor under this Agreement, whether expressly, by implication, estoppel or otherwise. All rights in the Program not expressly granted under this Agreement are reserved. Nothing in this Agreement is intended to be enforceable by any entity that is not a Contributor or Recipient. No third-party beneficiary rights are created under this Agreement.

Exhibit A – Form of Secondary Licenses Notice

“This Source Code may also be made available under the following Secondary Licenses when the conditions for such availability set forth in the Eclipse Public License, v. 2.0 are satisfied: {name license(s), version(s), and exceptions or additional permissions here}.”

Simply including a copy of this Agreement, including this Exhibit A is not sufficient to license the Source Code under Secondary Licenses.

If it is not possible or desirable to put the notice in a particular file, then You may include the notice in a location (such as a LICENSE file in a relevant directory) where a recipient would be likely to look for such a notice.

You may add additional accurate notices of copyright ownership.